



XRI®
Hazardous Duty™
BCP Series



Product Catalog

COMMERCIAL AND INDUSTRIAL SB300

2014

A Regal Brand

REGAL



Solutions for the Long Run

marathonTM
Motors

A century of customer care and innovation

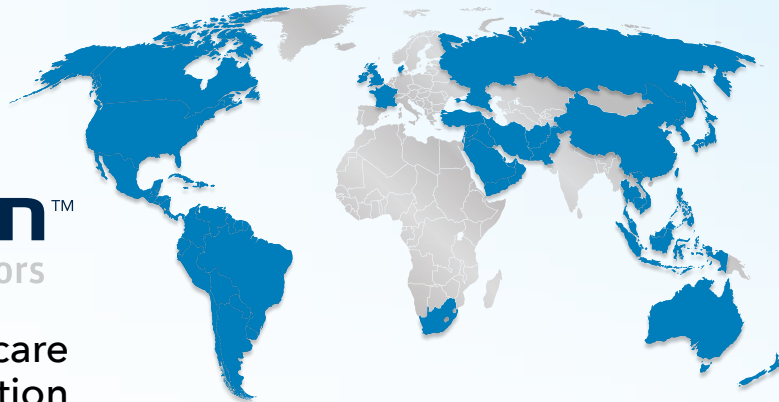

100 years ago, before Marathon became a proud flagship brand in the Regal family, Marathon began manufacturing motors under four simple founding principles:

- Serve customers according to their needs
- Produce the most efficient and long-lasting motors
- Commit to new technology and research
- Expand and diversify into new markets

We still live by these core philosophies today. They are the foundation of our ability to offer sustainable, customized solutions for our valued customers.

1913
Marathon company founded

1914

Founders design the 1/4 HP washing machine motor

1918

Austin Kimble designs a wide variety of fans along with a product called "A drive of a million speeds"

1932

Producing 57,000 electric motors per year

1940

Marathon's current plant and national headquarters is constructed

Late '40s

Producing over 300,000 electric motors/year



1949

Purchase of generator manufacturer, Burke Electric of Erie, PA and its Bowling Green, OH fuse and terminal block division which became Marathon Special Products

1968

All generator production consolidated in the Wausau facilities

1970s



1991

Marathon "fracket," a one-of-a-kind patented design for encoder and brake mounts, introduced

BlueMAX[®], the first line of inverter duty motors, introduced

Fidelity Electric is purchased, significantly expanding Marathon's product offering of 5-20kW Pancake generators

DVR2000, the first digital voltage regulator in the power generation industry, is introduced

1913

Marathon company founded

1920s



1922

Fractional motors and fans are trademarked as "Marathon OK"



1960

1/20 HP through 3500 HP motors introduced

Marathon motors made up 95% of the motors installed in a major Panama Canal upgrade

1960s



1983

Four-In-One motor (one stock motor capable of replacing four motors) introduced

1984

Patented Voltage Change Device (VCD[™]) revolutionary design introduced for voltage change

1986

Generators manufactured by Marathon chosen as backups for the lighting ceremony of the Statue of Liberty

Purchased Lima Electric, in Ohio - making Marathon the world's largest independent producer of electrical generators

Marathon introduces XRI product line - leading the industry in NEMA Premium[®] efficiencies

Solutions for the Long Run

Specifications	Features	GLOBE-TROTTER®	BLUE CHIP® XRI®	BLUE CHIP® XRI® SD	BLUE CHIP® XRI® 841	BLUE CHIP® XRI® XP
Enclosures	Totally Enclosed Fan Cooled	•	•	•	•	•
	Open Dripproof	•	•	•	•	•
Voltage	208-230/460 volt through 100 HP, 460 volt 125 HP and larger	•	•	•	•	•
	230/460 volt through 100 HP, 460 volt 125 HP and larger	•	•	•	•	•
	460 volt (three lead)	•	•	•	•	•
	575 volt (three lead)	•	•	•	•	•
Service Factor (sine wave)	1.15	•	•	•	•	•
	1.25 through 40 HP (see SB300 catalog for restrictions)	•	•	•	•	•
Inverter Duty	10:1 variable torque	•	•	•	•	•
	Up to 10:1 constant torque	•	•	•	•	•
	Up to 20:1 constant torque	•	•	•	•	•
	Provisions to add hollow shaft encoder (TEFC only)	•	•	•	•	•
Insulation System	Non-hygroscopic Class F system 143T-445T, Class H 447/9T	•	•	•	•	•
	MAX GUARD®	•	•	•	•	•
Balance	Special balance average 0.08 in./sec.	•	•	•	•	•
Bearings & Lubrication	Shielded ball bearings, C-3 fit with premium Mobil Polyrex EM grease (-30°C to +150°C)	•	•	•	•	•
	Open bearings, 364T Frame and larger	•	•	•	•	•
	Zerk fittings (Globetrotter 324T and larger)	•	•	•	•	•
	Extended grease tubes for regreasing without disassembly	•	•	•	•	•
Bearing Caps	Cast iron, 182T and larger	•	•	•	•	•
	Cast iron, 254T and larger	•	•	•	•	•
	Cast iron, 444T and larger	•	•	•	•	•
Construction	Rolled Steel	•	•	•	•	•
	Cast Iron	•	•	•	•	•
Conduit Box	Steel 56-326T, Cast iron (364T and larger, non threaded)	•	•	•	•	•
	Steel 143T-215T, Cast iron 254T and larger, non threaded	•	•	•	•	•
	Cast iron, oversized, fully gasketed	•	•	•	•	•
Leads	Lead lugs 364T and larger	•	•	•	•	•
	Permanently marked leads with lead separator	•	•	•	•	•
Fan Guard (TEFC)	Polypropylene (143T-213T), Steel (254T and larger)	•	•	•	•	•
	Polypropylene (182T-326T)	•	•	•	•	•
	Cast iron (including XRI 364T and larger)	•	•	•	•	•
Fan (External)	Non-sparking polypropylene (TEFC)	•	•	•	•	•
Drains	Corrosion resistant brass drain and breather	•	•	•	•	•
	Drilled and tapped hole	•	•	•	•	•
	Drain hole 143T-326T, drilled and tapped hole 364T and larger	•	•	•	•	•
Epoxy Finish	Internal and external corrosion resistant epoxy	•	•	•	•	•
Hardware	Corrosion resistant zinc dichromate plated hex head hardware	•	•	•	•	•
	Lifting provisions, 182T and larger	•	•	•	•	•
Ground	Ground lug provision in conduit box	•	•	•	•	•
	External grounding provision	•	•	•	•	•
Nameplate	Stainless steel - includes NEMA nominal efficiency and power factor	•	•	•	•	•
	AFBMA bearing identification plate	•	•	•	•	•
Seals	Inpro/Seal VBX Bearing Isolators on drive end of TENV and both ends of TEFC	•	•	•	•	•
Slinger	Molded neoprene slinger on shaft end	•	•	•	•	•
Marine Duty	Meets IEEE45 and USCG	•	•	•	•	•
	Meets API RP14F for offshore platforms	•	•	•	•	•
Division 1 Hazardous Duty	CSA Certification, UL Listed, Class I & II Groups C,D,F,G, Temperature Code T3B	•	•	•	•	•
Division 2 Hazardous Duty	CSA Certification nameplate, Class 1 Groups A, B, C, D, Temperature Code T2B	•	•	•	•	•
Motor Testing	Actual short commercial test data supplied for catalog numbers that do not end with "A"	•	•	•	•	•
	Actual short commercial test data plus max. vibration test supplied with each motor	•	•	•	•	•
	Actual short commercial test data plus 2 additional vibration tests supplied with each motor	•	•	•	•	•
Agency Listings	UL Recognized	•	•	•	•	•
	CSA Certified	•	•	•	•	•
	CE Mark	•	•	•	•	•
Warranty	36 mo. from date of first use, 42 mo. from date of manufacture	•	•	•	•	•
	60 mo. from date of first use, 66 mo. from date of manufacture	•	•	•	•	•
	Optional extended warranty	•	•	•	•	•



Globetrotter®
TEFC & ODP



Blue Chip® XRI®
TENV & TEFC



Blue Chip® XRI® - Severe Duty
TENV & TEFC



Blue Chip® XRI® - 841
IEEE 841



Blue Chip® XRI® - Hazardous Duty
Division 1, Class I & II
Groups C, D, F & G





IN THIS CATALOG

- 05 General Information
- 11 Application Information
- 17 Variable Speed Information
- 21 Single Phase
- 36 General Purpose Three Phase
- 65 Severe Duty
- 75 Explosion Proof
- 82 Medium Voltage
- 84 Inverter Duty "Max" Family
- 92 PMDC
- 94 IEC Motors
- 97 Brake Motors
- 99 Farm Duty / Agricultural
- 105 Washdown: Painted and Stainless Steel
- 119 Pump Motors (Fluid Handling)
- 159 HVAC / Air Moving
- 181 OEM Replacements
- 187 Definite Purpose
- 196 Modifications through MOD Central
- 207 Kits and Accessories
- 228 Index
- 272 Terms and Conditions

1996

BlackMAX® Vector Duty xpmotors introduced
Marathon Gexin joint venture established

1997

MAX GUARD® insulation system introduced, exceeding requirements of NEMA MG1, Part 31
Marathon Electric is acquired by Regal

2001

microMAX® motor awarded "Product of the Year" by Plant Engineering magazine

2002

First true world-class motor, IEC Globetrotter®, introduced

2006

Marathon adds a line of IEC motors to expand the offering and capability to compete with global demands



2007



2010

Highly efficient SyMAX™ permanent magnet AC motor introduced, making Marathon a leader in permanent-magnet motor technology

Mariner DEP/SS generator for Marine Diesel Electric Propulsion is introduced

CMG Pty Ltd is acquired by Marathon and proudly stands behind the Marathon brand

2013

Marathon celebrates 100 years in business



1998

Marathon becomes only motor company to claim unlimited lead length between motor and drive

1999

MagnaPOWER™ 1000 frame generator product line introduced

2000

Blue Chip® Severe Duty Explosion Proof motor named Plant Engineering magazine product finalist

Thomson Technology, Inc. of Vancouver, British Columbia, joins Regal allowing the company to offer a full system solution in power generation and controls

2004

Regal acquires the commercial AC motor division of General Electric which later rolls into Marathon's product offering

2005

6800 frame introduced, expanding capability to 1250 HP
Mariner line of generators for harsh duty environments introduced

2008

Marathon acquires motor company in China, offering motors up to 10MW and generators up to 2250 kVA

2011

DVR2000E+ digital voltage regulator introduced, providing easy set up

2012

Simplified "Marathon" becomes a flagship Regal brand

marathon[™]
Motors

Table of Contents

Page No.	Page No.
General Information	
Nameplate Information	5
Model number nomenclature	6
Doing business with Marathon Motors	7
Operation, Maintenance and Storage	8
Service and Warranty	9
Submittal data	9
Application Information	
Agency Information	11
Mechanical and Electrical considerations	11
Hazardous Duty™ overview	12
Terminology	15
Formulas and Conversion factors	16
Variable Speed Information	
Guidelines for general purpose motors on VFD	17
Application considerations	18
NEMA MOTORS (AC Induction)	
General Purpose Single Phase (NEMA Service Factor)	
Dripproof	
Rigid Base	21
Extended Thru-Bolt, Split Phase, Steel endshield	22
Rigid Base (1.0 Service Factor)	23
Resilient Base (Single and Two-Speed)	24
Resilient Base (1.0 Service Factor)	25
C-Face Footless	27
C-Face Footed (Rigid Base)	28
Totally Enclosed	
Rigid Base	29
C-Face Footless	31
C-Face Footed (Rigid Base)	32
C-Face Footed (Removable Base) - Four in One	33
C-Face Footed (Removable Base) - Four in One 50 Hertz	33
Hazardous Duty™ Division 1 Explosion Proof, Class I and II, Groups C (as noted), D, F, G	
Rigid Base and Resilient Base	34
C-Face Footless and C-Face Footed (Rigid Base)	35
General Purpose Three Phase	
Dripproof	
Rigid Base, 50 Hz, Standard Efficiency	195
Rigid Base	36
C-Face Footless	40
C-Face Footed (Rigid Base)	41
Rigid Base, NEMA Premium® XRI® Efficiency	42
Rigid Base, NEMA Premium® Globetrotter®	45
Medium Voltage - NEMA Premium® XRI® Efficiency	86
Totally Enclosed	
Rigid Base	47
Blue Chip®, Rigid Base, Standard and EPEfficiencies	49
C-Face Footless	51
C-Face Footed (Rigid and Removable Base)-Four in One	53
Rigid Base, NEMA Premium® XRI® Efficiency	56
C-Face Footed (Rigid Base), NEMA Premium® XRI® Efficiency	60
Rigid Base, NEMA Premium® Globetrotter®-NEMA Efficiency	61
C-Face Footless NEMA Premium® Globetrotter®-NEMA Efficiency	63
C-Face Footed (Rigid Base), NEMA Premium® Globetrotter®-NEMA Efficiency	63
Severe Duty	
C-Face Footless / Wet Environment / Car Wash Motor	65
Blue Chip® Severe Duty, Rigid Base	65
Blue Chip® Severe Duty, Cooling Tower, TEAO, Rigid Base, Three Phase	66
Blue Chip® Severe Duty, Rigid Base, NEMA Premium® XRI® Efficiency	67
Blue Chip® Severe Duty IEEE-841, Rigid Base, NEMA Premium® XRI® Efficiency	71
Medium Voltage - NEMA Premium® XRI® Efficiency	82
Explosion Proof	
Blue Chip® Severe Duty, C-Face Footed (Rigid Base)	75
Hazardous Duty™, Division 1 Explosion Proof, Class I and II, Groups C (as noted), D, F, G Steel frame, Rigid Base	76
C-Face Footless, Standard and EPEfficiency	77
Blue Chip® Severe Duty, Rigid Base, EPEfficiency	78
Blue Chip® Severe Duty, Rigid Base, NEMA Premium® XRI® Efficiency	79
Black Max® Vector Duty Explosion Proof, C-Face Footed (Rigid Base)	87
Blue Max® Vector Duty Explosion Proof with Encoder, C-Face Footed (Rigid Base)	89
Hazardous Duty™, Division 2/Zone 2 Totally Enclosed, Class I	
Blue Chip®, Severe Duty, Rigid Base, NEMA Premium® XRI® Efficiency	67
Blue Chip® Severe Duty IEEE-841, Rigid Base, NEMA Premium® XRI® Efficiency	71
Medium Voltage	82
Inverter (Vector) Duty: "MAX"-series AC Variable Speed motors	
microMAX® Totally Enclosed, C-Face Footless and C-Face Footed (Rigid Base)	84
Max-Plus (with Encoder), Totally Enclosed, C-Face Footed (Rigid Base)	85
Black Max® Totally Enclosed, C-face Footed (Rigid Base)	86
Black Max® Explosion Proof, C-Face Footed (Rigid Base)	87
Blue Max® Totally Enclosed, Rigid Base and C-Face Footed (Rigid Base)	88
Blue Max® Explosion Proof, with Encoder, C-Face Footed (Rigid Base)	89
Blue Max® Brakemotor, Totally Enclosed, C-Face Footed (Rigid Base)	90
SyMAX PMAC	91
Permanent Magnet DC	
SCR Rated, Totally Enclosed, C-Face Footed (Removable Base)	92
Washdown, SCR Rated, Totally Enclosed, C-Face Footed (Removable Base)	93
Low Voltage, Totally Enclosed, C-Face Footed (Removable Base)	93
IEC METRIC MOTORS (AC Induction)	
Totally Enclosed	
Globetrotter® - B3 mount	94
Globetrotter® - B14 and B35 (flange) mount	96
Flange Kits	212
Brakemotors	
Single Phase, Totally Enclosed, C-Face Footed (Removable Base)	97
Three Phase, Totally Enclosed, Rigid Base	97
Three Phase, Totally Enclosed, C-Face Footless	97
Three Phase, Totally Enclosed, C-Face Footed (Removable Base)	98
Blue Max® Vector Duty Brakemotor, C-Face Footed (Rigid Base)	90
Brake kits: Four-in-One and Black Max®	213

Table of Contents

Page No.	Page No.
Farm Duty / Agricultural	
Aeration Fan, Single Phase, TEAO, Rigid Base (see HVAC/Air Moving section)	163
Fan - Single Phase Capacitor Start, TEAO, Rigid Base - High Efficiency	100
Fan - Single Phase, TEAO, Resilient Base-Thru Bolt	102
Fan - PSC, TEAO, Resilient Base-Thru Bolt - Variable Speed	101
Fan - Single Phase, TEAO, Direct Drive-Thru Bolt - Single and Two Speed	104
High Torque, Single Phase, TEFC, Rigid Base	99
High Torque, Single Phase, TEFC, C-Face Footed (Rigid Base)	99
Extra-High Torque Chore Motor®, Single Phase, TEFC, Rigid Base	100
Auger Drive, Single Phase, TEFC, N-Flange	100
Crop Dryer, Single Phase, Dripproof/Air Over, Rigid Base	103
Crop Dryer, Three Phase, Dripproof/Air Over, Rigid Base	103
Grain Stirring, Single Phase, TEFC, Rigid Base	103
Incubator/Hatchery Vent Fan, PSC, TEAO, Thru-Bolt	104
Center Pivot Irrigation, Three Phase, TEFC, with Drip Cover	104
HVAC motors (Air Moving)	
Aeration Fan (see also Farm/Ag Duty)	163
Attic Fan	163
Centrifugal Fan	164
Circulator Pump, Single Phase, Dripproof - see also Pump/Fluid Handling section	178
Condenser Fan/Heat Pump, "ME-CAN-DO" multi-horsepower	179
Condenser Fan/Heat Pump, PSC, Dripproof, Resilient Ring, Thru-Bolt	163
Condenser Fan/Heat Pump, PSC, Open Air Over, Thru-Bolt, Shaft Up or Horizontal	160
Condenser Fan/Heat Pump, PSC, Open Air Over, Thru-Bolt, Shaft Down	161
Condenser Fan/Heat Pump, PSC, Open Air Over, Thru-Bolt, All-Angle	162
Condenser Fan/Heat Pump, PSC, Open Air Over, Resilient Ring, Thru-Bolt	163
Condenser Fan/Heat Pump, PSC, Open Air Over, Rigid Base, Shaft Up or Horizontal	162
Condenser Fan/Heat Pump, Three Phase, Open Air Over, Belly Band/Resilient Ring, Shaft Up or Horizontal	165
Commercial Condenser Fan/Heat Pump, PSC, Open Air Over, Belly Band, Shaft Up	163
Commercial Condenser Fan/Heat Pump, PSC, Resilient Base, Shaft Up or Horizontal	164
Commercial Condenser Fan/Heat Pump, Three Phase, Dripproof, Belly Band, Shaft Up	164
Exhaust Ventilator, Single Phase, Dripproof, C-Face Footless - Single and Two Speed	174
Exhaust Ventilator, Single Phase, Explosion Proof, C-Face Footless	35
Fan & Blower - Direct Drive, ME-CAN-DO mutli-horsepower	179
Fan & Blower - Direct Drive, PSC, Open Air Over, Resilient Ring	168
Fan & Blower - Direct Drive, PSC, Open Air Over, Resilient Ring, Thru-Bolt mount	166
Fan & Blower - Direct Drive, PSC, Open Air Over, Extended Thru-Bolt, 460 Volt	167
Fan & Blower - Direct Drive, PSC, Open Air Over, Torsion Flex mount	167
Fan & Blower - Direct Drive, PSC, Open Air Over, Belly Band Thru-Bolt, Double Shaft	168
Fan & Blower - Split Phase, Dripproof, Resilient Base - Single and Two Speed	169
Fan & Blower - Capacitor Start, Dripproof, Resilient Base - Single and Two Speed	171
Fan & Blower - Split Phase and Capacitor Start, Totally Enclosed, Resilient Base - Single and Two Speed	172
Fan & Blower - Single Phase, Explosion Proof, Resilient Base	34
Fan & Blower - Three Phase, Dripproof, Resilient Base - Single and Two Speed	173
Fan & Blower - Three Phase, TEAO, Resilient Base	157
Furnace Blower (see Fan & Blower motors)	
Furnace Blower - PDQ mount	174
Kiln Duty	191
ME-CAN-DO (Multi-Horsepower), Condenser Fan, PSC, TEAO, Thru-Bolt	179
ME-CAN-DO (Multi-Horsepower), Fan & Blower - Direct Drive, PSC, Open Air Over, Resilient Ring, Thru-Bolt	180
Two-Speed, One-Winding and Two-Winding, Variable Torque, Three Phase, Dripproof, Rigid Base	189
Oil Burner, PSC, 48M flange mount	175
Oil Burner, Split Phase and Capacitor Start, 48M and 48N flange mount	175
Oil Burner, Split Phase and Capacitor Start, 56C Footless	176
Oil Burner, Three Phase, C-Face Footless (see also Centrifugal Pump, Three Phase)	176
Pedestal Fan, PSC, TEAO, Yoke Mount	186
Refrigeration Fan - Single Phase	177
Refrigeration Fan - Three Phase (see also Condenser Fan/Heat Pump, Three Phase)	177
Transformer Cooling Fan, TEAO, Single Speed, Rigid Base	178
Unit Heater Fan, PSC, TEAO, Resilient Base	178
OEM replacement aftermarket motors	
Definite Purpose Motors	
Aggregate Duty	187
Air Compressor	187
Automotive Duty	
T-Frame: GM 7E-TA (Blue Chip® Severe Duty IEEE-841, Rigid Base, NEMA Premium® XRI®	74
T-Frame: Ford EM-1 (Blue Chip®, Severe Duty, Rigid Base, NEMA Premium® XRI®	69
Car Wash	
Blue Chip® Severe Duty, C-Face Footless w/ SS Shaft	65
Cooling Tower	
Single-Speed, Blue Chip® Severe Duty, Three Phase, Totally Enclosed, Rigid Base-IP55	65
Single-Speed, Blue Chip® Severe Duty, Three Phase, Totally Enclosed, Rigid Base-IP56	65
Two-Speed, Blue Chip® XRI® Severe Duty, Three Phase, Totally Enclosed, Rigid Base	188
Instant Reversing	
Single Phase Capacitor Start and PSC, Dripproof and Totally Enclosed	190
Kiln Duty	
Multi-Speed	
Two-Speed, One-Winding and Two-Winding, Variable Torque, Three Phase, Dripproof, Rigid Base	189
Oil Well Pump	

Table of Contents

	Page No.		Page No.
Pressure Washer			
Single Phase, Dripproof, Rigid Base and C-Face Footed (Rigid Base)	193	PowerWash™ XT Washdown Duty, Single Phase, C-Face Footless	105
Single Phase, Totally Enclosed, Rigid Base and C-Face Footed (Rigid Base)	194	PowerWash™ Washdown Duty, Single Phase, C-Face Footed (Rigid Base)	105
Pump motors (Fluid Handling)			
Carbonator Pump, Split Phase, Dripproof	119	PowerWash™ XT Washdown Duty, Three Phase, Rigid Base	106
Centrifugal Pump (Jet Pump), Single Phase, Dripproof, C-Face Footless, 56C/56J	120	PowerWash™ XT Washdown Duty, Three Phase, C-Face Footless	107
Centrifugal Pump (Jet Pump), Single Phase, Dripproof, C-Face Footed (Rigid Base), 56J	121	PowerWash™ XT Washdown Duty, Three Phase, C-Face Footed (Rigid Base)	108
Centrifugal Pump (Jet Pump), Single Phase, Totally Enclosed, C-Face Footless, 56C/56J	121	PowerWash™ XT Washdown Duty Close Coupled Pump, JM, Rigid Base	109
Centrifugal Pump (Jet Pump), Three Phase, Dripproof, C-Face Footless, 56C/56J	122	PowerWash™ XT Washdown Duty Centrifugal Pump (Jet Pump), C-Face Footless, 56J	109
Centrifugal Pump (Jet Pump), Three Phase, Dripproof, C-Face Footed (Rigid Base), 56J	122	PowerWash™ XT Washdown Duty Centrifugal Pump (Jet Pump), C-Face Footed, 56J	109
Centrifugal Pump (Jet Pump), Three Phase, Totally Enclosed, C-Face Footless, 56C/56J	123	PowerWash™ XT Washdown Duty Brakemotor C-Face Footed and Footless	109
Centrifugal Pump (Jet Pump), Three Phase, Totally Enclosed, C-Face footed (Removable Base), 56J	123	PowerWash™ SXT Washdown Duty, Single Phase, C-Face Footed (Rigid Base)	110
Circulator Pump, Single Phase, Dripproof - see also HVAC/Air Moving section	178	PowerWash™ SXT Washdown Duty, Three Phase, Stainless, C-Face Footless	111
Close Coupled Pump, JM, Single Phase, Dripproof, C-Face Footed (Rigid Base)	124	PowerWash™ SXT Washdown Duty, Three Phase, Stainless, C-Face Footed (Rigid Base)	112
Close Coupled Pump, JM, Single Phase, Totally Enclosed, C-Face Footed (Rigid Base)	124	PowerWash™ SXT PLUS Washdown Duty, Single Phase, Stainless/BISSC, C-Face Footless	113
Close Couple Pump, JM, Three Phase, Dripproof, C-Face Footed NEMA Premium® Globetrotter®-NEMA Efficiency	127	PowerWash™ SXT Washdown Duty, Single Phase, C-Face Footed (Rigid Base)	113
Close Coupled Pump, JM, Three Phase, Dripproof, C-Face Footless (Vertical) and C-Face Footed (Rigid Base)	125	PowerWash™ SXT Washdown Duty, Three Phase, Stainless/BISSC, C-Face Footless	114
Close Coupled Pump, JM, Three Phase, Totally Enclosed, C-Face Footed (Rigid Base)	130	PowerWash™ SXT PLUS Washdown Duty, Three Phase, Stainless/BISSC, C-Face Footed (Rigid Base)	115
Close Coupled Pump, JP, Single Phase, Dripproof, C-Face Footed (Rigid Base)	132	PowerWash™ SXT PLUS Washdown Duty, Three Phase, Closes Couple Pump JM (Rigid Base)	116
Close Couple Pump, JM, Three Phase, Totally Enclosed, C-Face Footed NEMA Premium® Globetrotter®-NEMA Efficiency	132	PowerWash™ SXT PLUS Washdown Duty, Three Phase, C-Face Footed (Rigid Base) Brake Motor	116
Close Coupled Pump, JP, Three Phase, Dripproof, C-Face Footless (Vertical) and C-Face Footed (Rigid Base)	135	PowerWash™ SXT PLUS Washdown Duty, Three Phase, C-Face Footed (Rigid Base) IEC	117
Close Coupled Pump, JP, Three Phase, Totally Enclosed, C-Face Footed (Rigid Base)	137	PowerWash™ SXT PLUS Washdown Duty, Three Phase, Stainless/BISSC, C-Face Footless	118
Close Couple Pump, JP, Three Phase, Dripproof, C-Face Footed NEMA Premium® Globetrotter®-NEMA Efficiency	138	PowerWash™ SXT PLUS Washdown Duty, Three Phase, Stainless/BISSC, C-Face Footed (Rigid Base)	118
Close Couple Pump, JP, Three Phase, TEFC, C-Face Footed NEMA Premium® Globetrotter®-NEMA Efficiency	140	Woodworking/Power Tool	195
Hydraulic Pump, Three Phase, TEFC	147	50 Hertz	195
Fire Pump, Three Phase, Dripproof, Rigid Base	144	Modifications through MOD Central	196
Fire Pump, Three Phase, TEFC, Rigid Base	146	Accessory Kits	207
Jet Pump (single compartment)-See Centrifugal Pump	121	"Specials are our Specialty"	226
Jet Pump, Two-Compartment, Single Phase, Dripproof, C-Face Footless, 56C/56J	120	Index	
Jet Pump, Two-Compartment, Single Phase, Dripproof, Square Flange	120	Catalog to Model Number	228
Oil Well Pump	192	Model to Catalog Number	253
Sump Pump, Split Phase, Dripproof	120	Terms and Conditions of Sale	272
Vertical Solid Shaft P-Base, Three Phase, Dripproof	153	Warnings and Cautions	276
Vertical Solid Shaft P-Base, Three Phase, Totally Enclosed	156	EISA - Frequently Asked Questions	277
Washdown - Painted and Stainless Steel			
PowerWash™ XT Washdown Duty, Single Phase, Rigid Base	105	NEMA MG-1 Table 12-11 EPA Efficiency	278
		NEMA MG-1 Table 12-12 NEMA Premium® Efficiency	279
		One Regal	280
		Footnotes	Flip Out
		Blue Chip® Product Line Comparison	IBC
		IEC Quick Reference Dimensional Chart	Flip Out

General Information

MARATHON MOTORS

Since 1913, Marathon Motors's name has been recognized for engineering excellence, custom-designed products and an extensive product line of industrial quality motors. Available in all popular enclosures from 1/12 HP through 3000 HP and in a variety of mounting configurations, Marathon Motors's unique designs provide more ways in which to add accessories, such as blowers, brakes and encoders, to our motors than anyone else in the motor business. Our state-of-the-art lab facilities are equipped and staffed with the finest resources available to ensure successful utilization of our products. Finally, as the preferred supplier of motors to most of the top drive manufacturers in North America, we have what it takes to be a leader in understanding the interaction of drives as they are applied with AC induction motors.

WEBSITE AND E-COMMERCE

Information can be accessed instantly, any time of the day on ME-business. Marathon customers can sign-up for ME-business by contacting their sales representative.

ME-business can be accessed through: www.marathonelectric.com.

- Stock Availability
- Order Status
- Shipping Information
- Invoice Information
- Product features and performance data



Marathon Motors Nameplate Information - HOW TO READ THE NAMEPLATE

The nameplate is the key to selecting the proper replacement motor.

Motor Specifications (Example)

- 1. **MODEL** - The ID number
- 2. **DATE CODE** - The month and year manufactured
- 3. **MTG.** - Mounting
- 4. **FRAME** - The size & mounting
- 5. **PART NO.** - Customer part number
- 6. **SER.** - Serial number
- 7. **TYPE** - Electrical type
- 8. **DES.** - Code by NEMA or IEC
- 9. **PH** - Electrical phase usually 1 or 3
- 10. **INS CL** - Insulation Class
- 11. **DUTY** - Time rating under load
- 12. **MAX AMB** - The allowable surrounding air temperature
- 13. **ENCL** - Enclosure (i.e. TEFC)
- 14. **RISE** - The temperature rise over ambient expressed in degrees Celsius when the motor operates at nameplated HP or KW
- 15. **IP** - Inherent Protection of the enclosure to solids and liquids as defined by IEC 34-5
- 16. **IC** - Inherent Cooling
- 17. **CODE** - NEMA locked-rotor KVA
- 18. **MTH/YR MFG.** - Month and year motor was manufactured
- 19. **WT/LBS** - Motor weight in pounds
- 20. **WT/KG** - Motor weight in kilograms
- 21. **HZ** - Input frequency of the power supply, usually 50 or 60 HZ
- 22. **VOLTS** - Voltage rating of the motor at the operating frequency
- 23. **HP** - Rated horsepower the motor will produce
- 24. **KW** - Rated output in watts
- 25. **F.L. AMPS** - The rated load current expressed in amps at nameplated horsepower with nameplate voltage and frequency
- 26. **S.F.** - Percentage of the rated horsepower the motor can safely operate at: Example: 1.15 SF (115% of rated HP)
- 27. **PF / COS** - Power Factor / Cosine is the ratio of actual power to the apparent power
- 28. **RPM** - Full load speed at rated frequency
- 29. **NOM EFF** - Average Efficiency
- 30. **SHAFT END BEARING** - Manufacturer drive end bearing number
- 31. **OPP. END BEARING** - Manufacturer opposite drive end bearing number
- 32. **SHAFT END BRG** - Drive end bearing size
- 33. **OPP** - Opposite drive end bearing size

Agency Symbols

- CSA Verification Mark - Complies with CSA's Energy Efficiency Verification Service and their Standard C390 - C390 is the Canadian efficiency equivalent of EPAct.
- Underwriters Laboratories, Inc. UL Recognized Component Mark
- UL file #
- CE (Conformité Européene) Marking This mark signifies the motor complies with the European Low Voltage Directive.
- CSA Mark - Certified by the Canadian Standards Association
- CSA file #
- CC# - Compliance Certification Number as per assigned by the Department of Energy. Motors meeting EPAct efficiencies or higher will have this number.

General Information

HOW TO READ A MODEL NUMBER:

Each Marathon Motors motor carries a model number that can be used to define some of the motor's physical and electrical characteristics.

Example (For Fractional): 1PC48C17D2000AP

This is a breakdown of the model on the nameplate:

1	P	C	48	C	17	D	2000	A	P
1	2	3	4	5	6	7	10	11	12

This is a breakdown of the model in the catalog:

48	C	17	D	2000
4	5	6	7	10

Example (For Integral): 2QA215TBDR A7076ALL

This is a breakdown of the model on the nameplate:

2	Q	A	215T	B	D	R	A	7076	AL	L
1	2	3	4	5	7	8	9	10	11	12

This is a breakdown of the model in the catalog:

215T	B	D	R	A	7076
4	5	7	8	9	10

1. **Date Code** - Year of Manufacture
(Not shown in catalog listings.)

2. **Thermal Protection** (Not shown in catalog listings.)

	UL Recognized Motor Protector Combination	UL Recognized Motor Construction
Automatic Reset	Automatic Reset	Automatic Reset
Q	Yes	Yes
S	No	No
U	No	Yes
W	#	Yes
Manual Reset	Manual Reset	Manual Reset
P	Yes	Yes
Z	No	Yes
X	No	No
None	None	None
V	No	Yes

Motor protector combination is U.L. recognized only if motor is used in direct drive fan duty application, and is under locked rotor condition, or is running under no-load condition.

3. **Date Code** - Month of Manufacturer (Not shown in catalog listings.)

4. **NEMA Frame Size** - (Integral motors - T and U designate standard shaft, TS and US designate short shaft)

5. Electrical Type

Single Phase:

- A = Permanent split capacitor
- B = Capacitor start, capacitor run
- C = Capacitor start, induction run
- N = Split phase start, capacitor run
- S = Split phase

Three Phase:

- T = Three phase
- H = Inverter Duty/IEEE841 Inverter Duty
- V = Medium Voltage

DC Power:

- E = Permanent Magnet DC

6. RPM or Speed at 60 Hz (Fractional Only)

- 34 = 2-Pole, 3600 rpm
- 17 = 4-Pole, 1800 rpm
- 11 = 6-Pole, 1200 rpm
- 8 = 8-Pole, 900 rpm

7. Enclosure

- D = Dripproof
- E = Explosion proof, non-ventilated
- F = Totally enclosed, fan cooled
- G = Explosion proof, fan cooled
- O = Open
- P = Partial
- S = Semi-enclosed
- T = Totally enclosed, non-ventilated
- V = Washdown, non-ventilated
- W = Washdown, fan cooled

8. Frame Construction

Integral

- L = Aluminum (Full Frame)
- Y = Aluminum (Full Frame)
- Z = Aluminum (High Mount Down Frame)
- H = Aluminum - Sourced
- R = Rolled Steel (Full Frame)
- W = Rolled Steel (Full Frame)
- X = Rolled Steel (High Mount Down Frame)
- B = Rolled Steel - Sourced
- S = Cast Iron (Full Frame)
- N = Cast Iron (Full Frame)
- P = Cast Iron (High Mount Down Frame)
- C = Cast Iron - Sourced
- D = Stainless Steel

Fractional (where applicable)

- B = Rolled Steel - Sourced
- D = Stainless Steel - Sourced
- U = Frameless - Sourced

9. **Style Letter** (A, B, C, etc. indicate redesign)

10. **Sequence Number**

11. **Minor Modification Letter(s)**
Fractional - 1 letter; Integral - 2 letters

12. **Manufacturing Code** - A code for the factory where the motor was manufactured.

General Information

HOW TO READ A MODEL NUMBER: Continued

Example ("harmonized" motor design):

A	B	C	D	E	F	G	H	I
5	KH	3	6	K	G	142	-	X

A. Rotating Device

B. Type of Winding

- KH - Split Phase
- KC - Capacitor Start, Induction Run
- K - Polyphase
- KCP - Permanent Split Capacitor
- KCR - Capacitor Start, Capacitor Run

C. Lamination Size

3 - 48 frame, 4 - 56 frame

D. Length of Frame

	48 frame	56 frame
2	5.17	5.73
3	5.42	6.63
4	None	None
5	5.80	7.11
6	6.23	None
7	6.63	7.63
8	7.23	8.44
9	Spec.	Spec.

E. Stack Length

A - 5/8"	F - 1-1/4"	L - 1-7/8"	S - 3.0"
B - 3/4"	G - 1-3/8"	M - 2.0"	T - 3-1/4"
C - 7/8"	H - 1-1/2"	N - 2-1/4"	U - 3-1/2"
D - 1.0"	J - 1-5/8"	P - 2-1/2"	W - 4.0"
E - 1-1/8"	K - 1-3/4"	R - 2-3/4"	Q - Spec.

F. Endshield Construction

- G & N - Aluminum
- K - Steel
- C - Cap/Can

G. Sequence Number

H. Current Revision (blank if original)

I. Type of Overload

- X - UL Auto running & locked rotor
- Y - UL Manual running & locked rotor
- S - UL Auto locked rotor
- T - Non-UL Auto running & locked rotor
- U - Non-UL Manual running & locked rotor
- V - Thermostat
- W - UL Motor Parts

ORDERING INFORMATION

When ordering, please include the model number, catalog number, description of the motor, quantity, shipping and billing instructions. For pricing of non-stock motors, or if you need assistance in selecting the proper motor, please contact your nearest Marathon Motors sales representative or local Marathon Motors Distributor. **All prices and data are subject to change without notice.**

CANCELLATIONS AND RETURNS

Stock Product

Stock product can be returned for credit as defined herein. Equipment must be in original packaging, unused in "as shipped" condition and is **limited to products currently maintained in stock inventory**. The quantity returned cannot exceed Marathon Motors's normal stock quantity level. All motors returned must have date codes no older than 18 months from date of manufacture. The minimum restocking charge is 15% of the original net purchase price. Modified and build to order motors cannot be returned for credit. Return freight charges are the responsibility of the customer returning the motor for credit. **No returns will be accepted without prior authorization.**

Non-stock Product Cancellation policy:

Cancellation charges for non-stock orders received and entered will be determined based on the percentage of completion in the engineering and manufacturing process, accounting for all costs plus a reasonable profit. Marathon Motors's determination of the cancellation charges shall be conclusive.

DISCOUNTS AND MULTIPLIERS

Except as noted, all prices in this catalog are list prices. 200 and 575 volt 3 phase ratings utilize the same list price as 230/460 volt. NEMA short shaft (TS) utilize the same list price as standard shaft (T). Contact Marathon Motors for special bearing systems, including all requirements for sleeve or roller bearing. For your discount and multiplier, contact your local Marathon Motors sales representative or local Marathon Motors Distributor.

MODIFICATION/ACCESSORIES

See the Modification/Accessories Sections for more information on modifications to create special motor variations.

General Information

STOCK, NON-STOCK AND BUILD UP MODELS

Standard motors listed in this catalog, as indicated with a check mark (¼) next to the catalog number, are normally in stock. There is no minimum order quantity or minimum billing charge associated with stock motors, unless stated otherwise in your quotation or agreement with Marathon Motors.

Production of non-stock catalog models and all build-up models is subject to minimum order quantities or setup charges listed below.

48-140 Frame = 25 piece minimum
 180-210 Frames = 5 piece minimum or \$200 set-up/model
 250-320 Frames = 5 piece minimum or \$300 set-up/model

Build-up motors must be thoroughly described at time of order, and/or associated with a formal quotation issued by Marathon Motors. **Inclusion of product features for similar motors documented in this catalog should not be assumed.**

SERVICE

For service on any Marathon Motors motor, contact your nearest Marathon Motors Authorized Service Station. For a complete listing of all domestic and foreign service stations, refer to www.marathonelectric.com.

OPERATION AND MAINTENANCE

For information on operation and maintenance, please consult the manual or card shipped with your new motor. Additional copies of "Installation, Operation & Maintenance Instructions" (brochure SB181) are available upon request or through our website, www.marathonelectric.com.

STORAGE PROCEDURES

In the event that long-term storage of motors is required, Marathon Motors recommends the following precautions and procedures. This information is also contained in "Installation, Operation and Maintenance Instructions" (SB181).

A. Keep motors clean

1. Store indoors
2. Keep covered to eliminate airborne dust and dirt.
3. Cover openings for ventilation, conduit connections, etc., to prevent entry of rodents, snakes, birds and insects.

B. Keep motors dry

1. Store in a dry area indoors
2. Temperature swings should be minimal to prevent condensation.
3. Space heaters are recommended to prevent condensation.
4. Treat unpainted flanges, shafts and fittings with a rust inhibitor.
5. Check insulation resistance before putting motor into service.

C. Keep bearings lubricated

1. Once per month, rotate shaft several turns to distribute grease in bearings.
2. If unit has been stored more than one year, add grease before start-up (refer to lubrication procedure).

DIMENSION DRAWINGS

See Marathon Motors's website: www.marathonelectric.com or request certified drawings through your Marathon Motors Sales Engineer, Representative or local Marathon Motors Distributor.

General Information

WARRANTY

Marathon Motors warrants Fractional and Integral motors to be free from defects in materials and workmanship and to conform to Marathon’s written specifications.

Motor Type	Warranty Period from Date of Installation*	Warranty Period from Date of Manufacture*
Standard Warranty for any product not shown below	12	18
Medium Voltage	12	18
EPAct compliant (aluminum, steel & cast iron frame)	24	30
Blue Chip® Severe Duty Explosion Proof	24	30
Blue Max®, Black Max®, & microMax™ Inverter Duty	36	42
All NEMA Premium® incl. ODP, Blue Chip®, Severe Duty, Explosion Proof, etc.	36	42
U-Frame Automotive Duty	60	66
Blue Chip® IEEE-841	60	66

* Warranty period shown is in months, and is valid for whichever period expires first.

Note: Brake discs are considered a normal maintenance item and are not covered under warranty.

For more information, on Marathon Motors’s warranty policy, refer to the “Terms and Conditions of Sale” (MPN411) in the back of this catalog.

SUBMITTAL DATA

Mechanical and electrical submittal data is available on many stock catalog motors through our website www.marathonelectric.com by following the three steps listed on the next page. All other submittal data is available upon request when accompanied by a purchase order for the specified motor, **subject to the following additional charges**

SUBMITTAL CHARGE SCHEDULE

TYPE	ELEMENTS	NET/EA
BASIC (.PDF format)	Nameplate data Motor characteristics Performance data Outline drawing External connection diagram	No-Charge
	Add for .dxf or .dwg format	\$25
BASIC-PLUS (.pdf format)	All “BASIC” elements, tailored to specific order. “Cut sheets” of installed accessories	\$75
	Add for .dxf or .dwg format	\$25
ADDITIONAL ITEMS (.pdf formats)	Speed/Torque curve	\$50
	Torque capability curve	\$50
	Commercial (end of line) test results (not available for West Plains motors)*	\$50
	Certificate of conformance	\$100
	Thermal damage curve (48-326T frame)	\$500 + cost of additional motor
	Thermal damage curve (364T-6805 frame)	\$1500 +cost of additional motor

* Does not imply retesting

General Information

1. From our homepage, click on the Motors link. From the Motors page, enter in the Marathon Catalog number or Model number.

Then click on Model number in results window.

(Note: If you already have a Marathon Motors motor and are looking for the performance data, make sure the model number off the nameplate is what you use for your search. Ex. 056H17T5301).

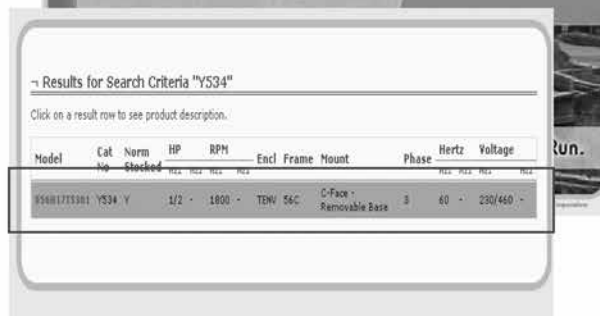

2. The Motor Model Details page will appear. You will be able to print dimensional drawings and connection diagrams in PDF format for the motors. Under the Technical Data section, [click on the link, Certification Data Sheet](#).



3. Your results will look similar to the [example](#) shown to the right for Marathon's 1/2 HP, Black Max® motor, model # 056H17T5301. It's that easy!

CERTIFICATION DATA SHEET

MODEL NUMBER: 056H17T5301
PART NUMBER: 056H17T5301
SERIAL NUMBER: 056H17T5301

TYPICAL MOTOR PERFORMANCE DATA

HP	kW	VOLTS	FL AMP	STATION	DEFY	ENCL	FR	MT	PHASE	SPD
1/2	.37	230/460	1.6/8	1800	1.0	56C	10	10	3	1800

EQUIPMENT WEIGHT CAPACITANCES (PER PHASE)

NO	K2	S1	S2	DN
0.000	0.000	0.000	0.000	0.000

SUPPLEMENTAL PERFORMANCE DATA

DEFLECTOR TYPE	DEFLECTOR SIZE	WINDUP TYPE	WINDUP SIZE	WINDUP LOCATION	TRIP COVER	WINDUP	PAINT
STANDARD	STANDARD	STANDARD	STANDARD	STANDARD	STANDARD	STANDARD	STANDARD

SPINNER TORQUE CONTACT ONLY
SEE SPINNER TORQUE CONTACT ONLY
SPINNER TORQUE CONTACT ONLY
SPINNER TORQUE CONTACT ONLY
SPINNER TORQUE CONTACT ONLY
SPINNER TORQUE CONTACT ONLY
SPINNER TORQUE CONTACT ONLY

Application Information

AGENCY LISTINGS

UL and CSA

Marathon Motors's Fire Pump and Explosion Proof motors are UL Listed. Other motor types are UL Recognized, including models with inherent overheating protection as noted (i.e. thermally protected models). Marathon motors are also CSA Certified for both explosion proof and non-explosion proof enclosures.

AC Motors

Non-Explosion Proof	UL File No.	CSA File No.
NEMA 48-449 Frame	E49747	LR2025
All 5K type models numbers	E46035	MC236833
NEMA 500 and 5000 Frame	—	LR2025*
IEC 63-90 Frame	E49747	LR2025
IEC 100-280 Frame	E49747	LR2025*
Thermally Protected motors	E6312	LR2025
Thermally Protected 5K motors	E14133	MC236833
Insulation Systems	E37900	LR2025
* Does not include coverage for use with VFD		
# Domestic product only		
Explosion Proof	UL File No.	CSA File No.
NEMA 56-326 Frame	E12044	LR47504
NEMA 364-449 Frame	E12044	LR21839
Fire Pump Motors	UL File No.	CSA File No.
NEMA 143-510	EX5190	LR2025
Class I, Division 2/Zone 2	UL File No.	CSA File No.
NEMA 48-449, 5000 Frame	—	LR21839
European ATEX Zone 2	Intertek Certificate No.	
NEMA 143-449, IEC 112-280	ITS06ATEX45370	

PMDC Motors

Non-Explosion Proof	UL File No.	CSA File No.
NEMA 56-145	E49747	E49747

CE (Conformity Europeenne)

CE marking on the nameplates of Marathon Motors motors is available upon request for most motors rated 600V or less. We do not apply the CE Marking to explosion proof motors. The European "Low Voltage" Directive applies to electric motors. Contact a factory representative for details. Non-explosion proof microMAX™, BlackMax® and BlueMax® (TENV and TEFC) standard (catalog) models have the CE Mark on the nameplate.

ATEX Directive (ATmospheres EXplosibles)

Mandatory by law, the European Union (EU) Directive 94/9/EC requires that electric motors for use in explosive atmospheres carry the CE mark, notified body identifier, Ex symbol, equipment group and category, plus the date code. See "European Installations" for additional details, located on the next page.

NEMA (National Electrical Manufacturers Association)

Marathon Motors motors are manufactured in accordance with all applicable areas of NEMA standards in MG1-2006. When applied in accordance with the "Guidelines for Application of Three Phase Motors on Variable Frequency Drives", **Marathon Motors motors are in full compliance with NEMA MG1-2006, Part 31, Section 4.4.2**, as pertaining to voltage spikes.

460 volt motors must withstand voltage spikes of up to 1426 volts; 575 volt motors must withstand spikes up to 1788 volts. See "Insulation Systems" for additional detail on this subject.

Commitment to RoHS and WEEE European Directives

European Directive 2002/95/EC "Restriction of Use of Certain Hazardous Substances" (RoHS) and Directive 2002/96/EC "Directives on Waste Electrical and Electronic Equipment" (WEEE) were enacted to control the amount of certain hazardous substances contained in products shipped into the E.U. Restricted substances include lead, mercury, cadmium, hexavalent chromium, polybrominated biphenyls and polybrominated dipheynl ethers.

The scope of products covered, affecting motors, is:

- Large household appliances
- Small household appliances
- IT and telecommunications equipment
- Consumer equipment
- Electrical and electronic tools (except large scale stationary and industrial tools)
- Toys, leisure and sports equipment
- Automatic dispensers

The Directives do not currently apply to medical devices, monitoring and control instruments, spare parts for the repair or reuse of electrical and electronic equipment placed on the market before July 1, 2006, and most military and state security equipment.

Regal Beloit Corporation worked closely with suppliers to assure that product falling within the scope of these Directives meets the specified levels of these substances. The Directives took affect July 1st, 2006 however many products were converted in May and June. The products converted are motors in NEMA frame size 145 and below, both AC and DC motors with the following exceptions:

- Sleeve bearing motors
- Brake motors in 56-145 frame will have to be ordered specifically as RoHS compliant.
- Some motors with specialty electro-mechanical components.

BEARINGS

FRAME SIZE	STANDARD TYPE	COMMENTS
48	Shield Ball	
56 - 184T	Sealed Ball	
182 - 444T	Double Shield Ball	
284 - 449TS	Single Shield Ball	
445T - 6805	Double Shield Ball	Direct - coupled loads
445T - 6805	Roller (DE)/Ball	Belted loads

* Belting data must be provided on all belted applications

Standard horizontal motors can be mounted in a vertical shaft down orientation (except brakemotors). Contact a factory representative for shaft up mounting arrangements.

Motors for use in vertical shaft up or shaft down configurations must be reviewed by Engineering before ordering.

Continued on next page.

Application Information

Marathon Motors motors employ the use of Mobil POLYREX[®] EM grease, a specially formulated bearing grease designed for electric motors. POLYREX[®] EM provides superior lubricity, durability and resists corrosion, rust and washout. POLYREX[®] EM is a registered trademark of Mobil Corporation.

Maximum safe mechanical speed capability is a function of bearing size, type and grease selection, as well as rotor balance specifications. Consult the "Maximum Safe Mechanical Speed Limits" chart in the "Overspeed Capability" section.

Note that these values do not imply maximum constant horsepower RPM.

EFFICIENCY

The efficiency of a motor is the ratio of its useful power output to its total power input and is usually expressed in a percentage. Marathon Motors offers standard, high efficient EPart, and NEMA Premium[®] efficient (XRI) ratings. Standard efficiency motors may only be used on applications that are exempt from legislated efficiencies. The high efficient motor line is in compliance with the Energy Policy Act of 1992 (EPart) and/or Canadian efficiencies as set by NRCAN. The Energy Independence and Security Act of 2007 (EISA07) will become law on December 19, 2010, requiring current EPart-compliant motors to meet NEMA Premium[®] efficiencies, and most EPart-exempt motors to meet EPart levels. XRI Premium efficient motors in this catalog meet NEMA Premium[®] unless otherwise noted.

The XRI[®] line is a premium efficiency line, which exceeds mandated efficiencies of EPart and /or NRCAN. Unless otherwise noted, XRI[®] premium efficient motors in this catalog meet NEMA Premium[®] the newly promoted efficiency levels by NEMA and the Consortium for Energy Efficiency (CEE).

ELECTRICAL TYPE/STARTING METHOD

Motors in this catalog are capacitor start, split phase, permanent split capacitor, or three phase. Capacitor Start motors have high starting torque, high breakdown torque, and relatively low starting current. Split phase motors have medium starting torque and medium starting current. Permanent split capacitor motors have low starting torque and low starting current. Three phase motors have high starting, extra breakdown torque, and typically very low starting current. Single phase motors cannot be applied on variable frequency drives with three phase output.

ENCLOSURE AND METHOD OF COOLING

Marathon Motors motors are available in various enclosures; Dripproof (DP), Dripproof Force Ventilated (DPFV), Totally Enclosed Fan Cooled (TEFC), Totally Enclosed Non-Ventilated (TENV), Totally Enclosed (TEAO) and Totally Enclosed Blower Cooled (TEBC). Application conditions will determine the type of motor enclosure required.

Dripproof motors have open enclosures and are suitable for indoor use and in relatively clean atmospheres. Dripproof motors have ventilating openings constructed so that drops of liquid or solid particles falling on the machine at an angle of not greater than 15 degrees from the vertical cannot enter the machine.

Totally enclosed motors are suitable for use in humid environments or dusty, contaminated atmospheres. Totally enclosed non-ventilated motors are NOT cooled by external means. Totally enclosed fan cooled motors are cooled by external means that are part of the motor but not in the internal workings of the motor. Totally enclosed air over motors are sufficiently cooled by external means, provided by the customer.

HAZARDOUS DUTY™

Hazardous Duty™ motors are totally enclosed (fan cooled or non-ventilated) motors designed for applications in hazardous atmospheres containing explosive gases and/or combustible dusts.

North American installations

North American standards for electric motors generally fall into one of two divisions. Division 1 Explosion Proof motors are UL Listed in accordance with NFPA Class I (Flammable Gases) or Class II (Combustible Dusts) and Groups (gases or dusts), depending upon the atmosphere. Division 2 motors are CSA Certified and are marked similarly to Division 1 equipment. Inverter Duty motors through 449T frames are CSA Certified for use in Division 2 locations.

European installations

Motors for hazardous locations in Europe must meet a different set of standards and require different markings than those of North America. CENELEC sets the standards for equipment in hazardous locations for Europe. Motors for use in explosive atmospheres in Europe are often referred to as flameproof (Zone 1) or non-sparking (Zone 2) motors. These motors must comply with the ATEX Directive. The ATEX Directive covers all electrical equipment used in explosive atmospheres. To ensure compliance with the Directive, equipment must meet the essential ATEX requirements and carry the CE mark on the nameplate. Other information required on the nameplate includes the Ex symbol, group & category, Ex protection method, gas group, and temperature code, example (Ex) II 3 G Ex nA IIC T3).

The tables on the next page describe Marathon Motors's capabilities by Area Classification and by Temperature Code.

IEC DEGREES OF PROTECTION vs. MARATHON MOTOR'S STANDARD CONSTRUCTION

The enclosure terminology for an IEC motor is a combination of the IP (Ingress Protection) and IC (Inherent Cooling) codes. Each number in the IP code stands for a different degree of protection.

- IP12 - Dripproof
- IP22 - Dripproof with screens, or die cast aluminum bracket
- IP43 - Totally Enclosed
- IP54 - Totally Enclosed Severe Duty
- IP55 - Totally Enclosed Severe Duty with V-Ring Shaft seals, and/or "Smart Ring" rotating shaft seal and Neoprene gaskets
- IP56 - Totally Enclosed Severe Duty with rotating Shaft seals (eg. Inpro/Seal[®] VBX bearing isolator) and Neoprene gaskets

Application Information

Marathon Motors Hazardous Duty Motor Area Classification Chart

Class I Area Classification (Flammable Gases, Vapors or Mists)				Class II Area Classification (Combustible Dusts)			
North America		Europe - ATEX (Category G - Gases)		North America		Europe - ATEX (Category D - Dusts)	
Division 1 Explosion Proof	Division 2 TEFC & TENV	Zone1 Flameproof	Zone 2 Non-Sparking	Division 1 Explosion Proof	Division2	Zone 21 Flameproof	Zone 22 Non-Sparking
Group A ^①	Group A	Contact Marathon Motors for ATEX Zone 1 capabilities	Group IIC, Category G	-	-	-	-
Group B ^②	Group B		Group IIC, Category G	-	-	-	-
Group C	Group C		Group IIB, Category G	-	-	-	-
Group D	Group D		Group IIA, Category G	-	-	-	-
-	-	-	-	Group E	-	Category D	Category D
-	-	-	-	Group F	Group F ^①	Category D	Category D
-	-	-	-	Group G	Group G ^①	Category D	Category D

- Group is not applicable to that Division or Zone, or is not defined.
- ① Group is not available from Marathon Motors.
- ② Contact factory representative for availability.

APPLICATION INFORMATION

Marathon Motors Hazardous Duty Motor Temperature Code Chart

	TEMPERATURE CODES		Division 1 Explosion Proof/Zone 1 Flameproof		Division 2/Zone 2 Non-Sparking
	UL/CSA	ATEX	Class I Area Classification (Flammable Gases, Vapors or Mists)	Class II Area Classification* (Combustible Dusts)	Class I Area Classification (Flammable Gases, Vapors or Mists)
Temp.	UL/CSA	ATEX	Division 1/Zone 1	Division 1/Zone 21	Division 2/Zone 2
280°C	T2A	T2(280)	Explosion Proof - Class I, Group D (Group C as noted)		
260°C	T2B	T2(260)			XRI® Severe Duty & IEEE-841 @ 1.15 S.F., Class I, Groups A,B,C,D (Sine wave power)
215°C	T2D	T2(215)			Available through Marathon's Mod Central on Totally Enclosed EPAct, XRI®, XRI® Severe Duty or IEEE-841 @ 1.0 S.F. on PWM VFD, Class I, Groups A, B, C, D
200°C	T3	T3			Available through Marathon's Mod Central on Totally Enclosed EPAct, XRI®, XRI® Severe Duty or IEEE-841 @ 1.0 S.F., Sine wave power Class I, Groups A, B, C, D
165°C	T3B	T3(165)	Explosion Proof - Class I, Group D (Group C as noted), Sine wave or PWM power	Explosion Proof - Class II, Groups F & G, Sine wave or PWM power	
160°C	T3C	T3(160)	Available through Marathon's Mod Central on Explosion Proof - Class I, Group C & D @ 1.0 S.F. - Contact Factory	Available through Marathon's Mod Central on Explosion Proof - Class II, Group F & G @ 1.0 S.F. - Contact Factory	
135°C	T4	T4	ATEX compliant motors	ATEX compliant motors	

Division I & II ambient range is -25°C to +40°C

ATEX ambient range is -20°C to +40°C

Consult Marathon Motors for higher ambients

Application Information

INSULATION SYSTEMS

Class B – General Purpose motors that employ Class B insulation systems have a total temperature rating of 130°C and maximum allowable temperature rise of 80°C at 1.0 S.F.

Class F – Motors with a Class F system have a total temperature rating of 155°C, with a maximum temperature rise of 105°C at 1.0 S.F. Many Marathon Motors designs utilize a Class F system but limit temperature rise to no higher than “B” rise, providing thermal “headroom” for longer insulation life.

Class H – Class H insulated motors have a total temperature rating of 180°C and maximum allowable temperature rise of 125°C. All Marathon Motors motors that employ a Class H system are designed to operate between “B” and “F” rise, giving the user a generous thermal cushion.

“CR200” – Corona Resistant, 200° rated magnet wire is utilized in numerous general purpose and inverter duty motor designs to extend insulation life under the rigors of steep fronted voltage spikes, common with today’s IGBT inverters. Refer to page 17 for product lines that employ the use of CR200 magnet wire.

Motors with the CR200 insulation system can be operated at up to 475 feet from the drive on 460 volt systems, at 3 KHz carrier frequency. For other voltages and/or carrier frequency combinations, contact a factory representative.

MAX GUARD® – All Black Max®, Blue Max®, Blue Chip®, XRI® Severe Duty and XRI®-841 (IEEE841) motors feature the MAX GUARD® insulation system, either in conjunction with Class F or Class H materials. Combining corona-resistant magnet wire (CR200) with our patented “low stress” winding configuration and uncompromising quality standards, MAX GUARD® delivers long, dependable motor life under the adverse thermal and dielectric stresses imposed by IGBT-based variable frequency drives. **MAX GUARD® surpasses the requirements of NEMA MG1-2006, Part 31, Section 4.4.2.**

460 Volt (or lower) motors equipped with MAX GUARD® can be operated at any distance from the drive and at any carrier frequency. 575 Volt motors can be operated at up to 650 feet cable length at 3 KHz.

MOUNTING

Most Marathon Motors motors are designed for horizontal mounting (shaft parallel with ground), unless designed otherwise, such as Vertical P Base motors. As a general rule, a horizontal motor can also be mounted in a vertical shaft down orientation. Horizontal motors should never be mounted in a vertical shaft up orientation without consulting your application engineer, as this practice can cause damage to the motor, which is not covered under warranty. Brake motors should not be mounted vertically (up or down), unless the brake has been specifically designed for such.

NEMA SERVICE FACTOR RATINGS

The table below lists the NEMA service factors for single phase, drip proof motors. Totally enclosed and explosion proof motors have 1.0 service factor except where noted.

Single Phase

NEMA SERVICE FACTOR @ RPM LISTED

HP	3600	1800	1200	900
1/12	1.4	1.4	1.4	1.4
1/8	1.4	1.4	1.4	1.4
1/6	1.35	1.35	1.35	1.35
1/4	1.35	1.35	1.35	1.35
1/3	1.35	1.35	1.35	1.35
1/2	1.25	1.25	1.25	1.15
3/4	1.25	1.25	1.15	1.15
1	1.25	1.15	1.15	1.15
1.5 & Up	1.15	1.15	1.15	1.15

OVERLOAD PROTECTION

There are four choices in protection: manual (inherent type), automatic (inherent type), thermostats, and none. A manual overload must be physically reset to restart the motor. An automatic thermal overload will stop the motor when it is overloaded or overheated and restart it after the motor has cooled down. None means the motor has no protection. Thermostats are embedded in the winding and connected to the motor starter control circuit. Marathon Motors’s standards are normally closed thermostats, one per phase.



A motor with an automatic reset protector must not be used where automatic restarting (after motor cool-down) would endanger personnel or equipment. Such applications should use a manual reset protector.

PHASE/POWER SUPPLY

Is the power supply three phase or single phase? Most home and farm applications require single phase motors, while most factories, large commercial and industrial users require three phase motors. Single phase motors can be used on three phase systems. Three phase motors, however, cannot be operated from single phase systems. Motor damage will result.

ROTATION

Most motors in this catalog are reversible by electrical reconnection or by physical orientation. Marathon Motors’s standard rotation from the factory for single phase motors is counterclockwise, when viewing the opposite shaft end of the motor.

SPEED/RPM

3600, 1800, and 1200 are the most common 60 HZ synchronous speeds with full load speed equivalents of 3450, 1725, and 1150.

Application Information

TERMINOLOGY

Ambient Temperature – Temperature of the medium, such as air, water or earth, into which the heat of the equipment is dissipated.

Across The Line Start - A method of motor starting that applies full line voltage to the motor. The motor is connected directly to the power source.

Base Speed – Nameplate rating where the motor will develop rated HP at rated load and voltage. With AC systems, it is commonly the point where 60 Hz is applied to the induction motor.

Breakaway Torque – The torque required to start a machine from standstill.

Breakdown Torque (BDT) – The maximum torque that an AC motor will develop with rated voltage applied at rated frequency while rotating.

Cogging – A condition in which a motor does not rotate smoothly but “steps” or “jerks” from one position to another during shaft revolution. Cogging is most pronounced at low motor speeds and can cause objectionable vibrations in the driven machine.

Continuous Duty – The continuous rating is the maximum constant load that can be carried continuously without exceeding established temperature rise limitations under prescribed conditions of load and within the limitations of established standards.

Definite Purpose Motor – Any motor design, listed and offered in standard ratings with standard operating characteristics and mechanical construction, for use under service conditions other than usual or for use on a particular type of application (NEMA).

Duty Cycle – The relationship between the operating and resting times or repeatable operation at different loads and/or speeds.

Efficiency – Ratio of power output to power input indicated as a percentage. In motors, it is the effectiveness with which a motor converts electrical power into mechanical power.

Frequency – Number of cycles per second of alternating current 60HZ used primarily in the United States, 50HZ normally used overseas.

Full Load Torque (FLT) – The torque necessary to produce rated horsepower at full load speed.

General Purpose Motor – This motor has a continuous duty rating and NEMA A or B design, listed and offered in standard ratings with standard operating characteristics and mechanical construction for use under usual service conditions without restriction to a particular application or type of application (NEMA).

Inertia – A measure of a body’s resistance to changes in velocity, whether the body is at rest or moving at a constant velocity. The velocity can be either linear or rotational. The moment of inertia (WK^2) is the product of the weight (W) of an object and the square of the radius of gyration (K^2). The radius of gyration is a measure of how the mass of the object is distributed about the axis of rotation. WK^2 is usually expressed in units of lb-ft².

Inrush Current – The initial surge of current into the windings. Inrush current can be up to ten times higher than the continuously needed current because there is low initial resistance.

Intermittent Duty – A motor that never reaches equilibrium temperature, but is permitted to cool down (to ambient temperature) between operations. For example, a crane, hoist or machine tool motor is often rated for 15, 30 or 60 minute duty.

Load Sharing – An application condition in which two or more similar-sized AC Induction motors are mechanically connected to each other and powered from the same inverter. Optimum load sharing is achieved with higher slip (NEMA Design B or C) motors.

Locked Rotor Current (LRA) – Steady state current taken from the line with the rotor at standstill, at rated voltage and frequency. This is the current when starting the motor and load across the line.

Locked Rotor Torque (LRT) – The minimum torque that a motor will develop at rest for all angular positions of the rotor, with rated voltage applied at rated frequency.

No Load (Conditions) – The state of a machine rotating at normal speed under rated conditions, but when no output is required from it.

Part Winding Start (PWS) – A method of reduced voltage starting that applies power to only one set of windings, then to the other set as the motor comes up to speed.

Power Factor – Power factor is the ratio of real power (kW) to total kVA, or the ratio of actual power (W) to apparent power (volt-amperes).

Reactance – The opposition to the flow of current made by an induction coil or a capacitor. Performance data expresses stator reactance as X1 and rotor reactance as X2.

Resistance – The opposition to voltage or current in an electrical circuit. Performance data expresses stator resistance as R1 and rotor resistance as R2.

Rotor – The rotating member of a machine with a shaft.

Service Factor (SF) – When used on a motor nameplate, a number which indicates how much above the nameplate rating a motor can be loaded intermittently without causing serious degradation (i.e. a motor with 1.15 SF can produce 15% greater torque than one with 1.0 SF, within temperature constraints).

Squirrel Cage Induction Motor – When used on a motor nameplate, a number which indicates how much above the nameplate rating a motor can be loaded without causing serious degradation (i.e. a motor with 1.15 SF can produce 15% greater torque than one with 1.0 SF, within temperature constraints).

Application Information

TERMINOLOGY

Shock Load – The load seen by a clutch, brake or motor in a system that transmits high peak loads. This type of load is present in crushers, separators, grinders, conveyors, winches and cranes.

Slip – The difference between the speed of the rotating magnetic field (synchronous speed) and mechanical rotational speed (rotor speed) of AC induction motors. Usually expressed as a percentage of synchronous speed.

Special Purpose Motor – A motor with special operating characteristics, special mechanical construction, or both, designed for a particular application and not falling within the definition of a general purpose or definite purpose motor (NEMA).

Speed Range – The minimum and maximum speeds at which a motor must operate under constant or variable torque load conditions. A 50:1 speed range for a motor with top speed of 1800 RPM means the motor must operate as low as 36 RPM and still operate within specifications.

Starting Torque – The torque exerted by the motor during the starting period.

Stator – The stationary portion of the magnetic circuit and the associated windings and leads of a rotating machine.

Synchronous Speed – The speed of an AC induction motor's rotating magnetic field. It is determined by the frequency applied to the stator and the number of magnetic poles present in each phase of the stator windings. Mathematically, it is expressed as Sync Speed (RPM) = $120 \times \text{Applied Frequency (Hz)} / \text{Number of Poles per phase}$.

Torque – A turning force applied to a shaft, tending to cause rotation. Torque is normally measured in "pound-feet" and is equal to the force applied times the radius through which it acts.

Torque-to-Inertia Ratio – The rated motor torque divided by its rotor inertia. Helps determine a motor's ability to accelerate loads and/or respond to commands from a drive to change speed or direction.

Voltage Drop – The reduction in voltage level from the source to the load caused by conductor resistance.

Wye Start Delta Run (YD) – A method of reduced voltage starting that first connects a motor in a wye to reduce voltage, then reconnects the motor in a delta to provide full line voltage.

FORMULAS & CONVERSION FACTORS

$$\text{Horsepower (HP)} = \text{Torque (lb-ft)} \times \text{RPM} / 5252$$

$$\text{Horsepower (HP)} = \text{Torque (lb-in)} \times \text{RPM} / 63025$$

$$\text{Torque (lb-ft)} = \text{HP} \times 5252 / \text{RPM}$$

$$\text{Torque (lb-in)} = \text{HP} \times 63025 / \text{RPM}$$

$$\text{Efficiency} = \text{Power Out} / \text{Power In}$$

$$\text{Synchronous RPM} = 120 \times \text{Frequency} / \# \text{ Poles}$$

$$\text{Ohms} = \text{Volts} / \text{Amperes} (R = E/I)$$

$$\text{Amperes} = \text{Volts} / \text{Ohms} (I = E/R)$$

$$\text{Volts} = \text{Amperes} \times \text{Ohms} (E = IR)$$

$$\text{Static Torque (T)} = F \times R \text{ (lb-ft),}$$

$$F = \text{Force (lb),}$$

$$R = \text{pulley or drum radius (ft)}$$

$$\text{Pound-feet (torque)} = .7376 \times \text{Newton-meters}$$

$$\text{Newton-meters (torque)} = 1.3558 \times \text{lb-ft}$$

$$\text{Power (HP)} = \text{Torque (lb-ft)} \times 2\pi \times \text{RPM} / 33000$$

$$\text{Temperature (Celsius)} = 5/9 \times (F^\circ - 32)$$

$$\text{Temperature (Fahrenheit)} = (9/5 \times C^\circ) + 32$$

$$1 \text{ Kilowatt (KW)} = 1.341 \text{ Horsepower}$$

$$1 \text{ Horsepower} = 746 \text{ watts (.746 KW)}$$

$$\text{Brake Torque} = (5252 \times P / N) \times \text{SF}, P = \text{HP}, N = \text{RPM}, \text{SF} = 1.4$$

Use 2.0 to 2.5 SF for cranes and hoists (consult crane manufacturer or end-user).

Variable Speed Operation

Guidelines for Application of General Purpose, Three Phase, Single Speed Motors on Variable Frequency Drives Meets NEMA MG1-2006 Part 30 and Part 31 Section 4.4.2 Unless stated otherwise, motor nameplates do NOT include listed speed range.

ENCLOSURE	EFFICIENCY	VARIABLE TORQUE	CONSTANT TORQUE								
		ALL FRAMES	56	143-215		254-286		324-365		404-449	
NEMA Motors		ALL POLES	ALL POLES	2-Pole	4&6 Pole	2-Pole	4&6 Pole	2-Pole	4&6 Pole	2-Pole	4&6 Pole
ODP	Standard (EPAAct exempt)	10:1	2:1	2:1	2:1	Contact Engineering					
	EPAAct compliant	10:1	N/A	2:1	2:1	2:1	2:1	Contact Engineering			
	NEMA Premium	10:1	N/A	10:1	10:1	10:1	10:1	10:1	10:1	2:1	2:1
TEFC	Standard (EPAAct exempt)	10:1	2:1	2:1	2:1	Contact Engineering					
	EPAAct compliant	10:1	N/A	2:1	10:1	2:1	10:1	2:1	2:1	2:1	2:1
	NEMA Premium	10:1	N/A	2:1	20:1	2:1	20:1	2:1	20:1 (1)	2:1	20:1 (1)
TENV	EPAAct compliant	10:1	N/A	1000:1	1000:1	1000:1	1000:1	1000:1	1000:1	1000:1	1000:1
	NEMA Premium	10:1	1000:1	1000:1	1000:1	1000:1	1000:1	1000:1	1000:1	1000:1	1000:1
Washdown TEFC	Standard (EPAAct exempt)	10:1	10:1 (2)	10:1 (2)	10:1 (2)	N/A	N/A	N/A	N/A	N/A	N/A
	EPAAct compliant	10:1	10:1 (2)	10:1 (2)	10:1 (2)	N/A	N/A	N/A	N/A	N/A	N/A
	NEMA Premium	10:1	10:1 (2)	10:1 (2)	10:1 (2)	N/A	N/A	N/A	N/A	N/A	N/A
Washdown TENV	Standard (EPAAct exempt)	10:1	1000:1	1000:1	1000:1	N/A	N/A	N/A	N/A	N/A	N/A
	EPAAct compliant	10:1	1000:1	1000:1	1000:1	N/A	N/A	N/A	N/A	N/A	N/A
	NEMA Premium	10:1	1000:1	1000:1	1000:1	N/A	N/A	N/A	N/A	N/A	N/A
Explosion Proof	All efficiency levels	Explosion Proof motors must be properly nameplated with inverter duty information prior to use on VFD. See Marathon catalog pages for specific rating capabilities. Motors with automatic overload protectors cannot be used on VFDs.									
IEC Motors		ALL FRAMES	63-90	100-225	250-315						
All Enclosures	All efficiency levels	10:1	20:1	Up to 20:1	Up to 2:1						

- Notes: (1) 324-449T, 4 & 6 Pole XRI motors are rated for 20:1 C.T. with fan modification; otherwise rated for 2:1 C.T. continuous duty, or 20:1 C.T. 60 minute duty at lowest RPM.
 (2) Washdown TEFC motors are rated for 10:1 C.T. 60 minute duty or 2:1 C.T. continuous duty at lowest RPM.
 Model numbers beginning with 5K are not suitable for use with Variable Frequency Drives.

Application Notes

Bearing currents	Marathon Motors recommends that any motors used with Variable Frequency Drives be equipped with suitable means to protect the motor bearings from shaft currents caused by common mode voltages inherent with operation on a non-sinusoidal power supply. Marathon Motors offers several options for motors in non-classified (non-hazardous) locations, including ground brushes, insulated bearings and non-contact shaft grounding rings. For more information on ground brushes and bearing currents, see the VARIABLE SPEED OPERATION section. For installation cost and available options, see the MOD CENTRAL section.
Restricted use	DO NOT APPLY THE FOLLOWING MOTORS ON VARIABLE FREQUENCY DRIVES: Single Phase motors, Motors with inherent overload protection, Multi-Speed motors, Motors with 1.0 Service Factor on sine wave power. Fire Pump motors should not be used with variable frequency power supplies, due to the critical nature of these applications.
Hazardous Locations	Consult with Marathon Motors when applying motors and drives into Hazardous Locations, either Division/Zone 1 or Division/Zone 2 areas. UL and CSA policies prohibit the installation of bearing protection devices, such as shaft grounding brushes, rings or insulated bearings on motors in Hazardous Locations.

Maximum Cable Lengths from the Motor to Drive

PRODUCT DESCRIPTION	3 kHz CARRIER FREQUENCY (PHASE TO PHASE)*		
	230 VOLT	460 VOLT	575 VOLT
56-326 NEMA, 100-225 IEC Frames	600 ft.	125 ft.	40 ft.
364-5013 NEMA, 250-315 IEC Frames	1000 ft.	225 ft.	60 ft.
Motors with CR ²⁰⁰ Corona Resistant Magnet Wire	1500 ft.	475 ft.	140 ft.
Motors with MAX GUARD® insulation system	Unlimited	Unlimited	650 ft.
Form-wound low voltage motors	Unlimited	Unlimited	650 ft.

* Higher carrier frequencies require shorter cable length to obtain normal (50Khrs) insulation life.

Standard Motor Insulation Systems

CR200 CORONA-RESISTANT MAGNET WIRE	Max Guard®*
microMAX® inverter duty "4 - in - 1" Three Phase, C-Face with Removable Base Standard Three Phase stock Brakemotors Blue Chip® Severe Duty Explosion Proof, EPAAct Efficiency Max +	Black Max® Vector Duty - All Product Blue Max® Vector Duty - All Products PowerWash™ XT, SXT, and SXT-Plus Washdown Duty - Three Phase Blue Chip® XRI Severe Duty Blue Chip® XRI-841 (IEEE841 compliant) Automotive Duty "T" Frame Blue Chip® Explosion Proof, XRI® Premium Efficiency Globetrotter® IEC Metric motors

Variable Speed Operation

VARIABLE SPEED INFORMATION

Marathon Motors Vector-Duty and Inverter-Duty motors, unless otherwise stated, are rated for continuous operation in a 40°C ambient and for altitudes up to 3300 feet (1000 meters) above sea level. Special application considerations, such as high or low ambient, intermittent ratings, high altitude, duty cycle rated, extended constant horsepower range, special base speed, voltage or frequency, or any other special requirements, should be reviewed by a factory representative.

It is the responsibility of the startup personnel during commissioning of the VFD/motor system to properly tune the drive to the motor for the specific application. The correct voltage boost and volts/hertz settings are application dependent and unique to each motor design. Procedures for these adjustments should be in your VFD user manual. Many Vector Duty and Inverter Duty motors in this catalog are equipped with thermostats; warranty coverage may be denied if they are not properly utilized.

WARNING Power factor correction capacitors should never be installed between the drive and the motor.



INVERTER DUTY OR INVERTER RATED

"Inverter Duty" (often called "Inverter Rated") motors are suitable for use with Variable Frequency Drives, as long as operation is within the application guidelines published in this catalog. In general, Marathon Motors's three phase, general purpose, NEMA Design B motors are considered "Inverter Duty", and meet or exceed the requirements of NEMA MG1, Part 30. As required under Federal law, these motors comply with EPAAct efficiencies when operating from utility power.

Many of Marathon's motor product lines have been enhanced to facilitate reliable operation on today's variable speed drives, including wider constant torque speed range (up to 20:1) and improved insulation systems that withstand voltage spikes common with variable frequency operation.

Inverter Duty (Rated) motors are most often used in 10:1 speed range, variable torque or constant torque applications. A vector control is usually required for operation beyond 10:1 CT.

Refer to "Guidelines for Application of General Purpose, Single Speed Three Phase Motors on Variable Frequency Drives" in this section of this catalog for the allowable speed range and cable length restrictions (from VFD to motor). Additional detail regarding a specific product's capabilities is available on its catalog page, or by consulting your application engineer.

VECTOR DUTY – "Vector Duty" describes a class of motors that are used in conjunction with Open- (without encoder) or Closed-Loop (with encoder) Vector controls, that provide enhanced performance under low speed operating conditions, or in cases where torque (rather than speed) must be controlled. "Vector Duty" motors can be applied to Volts/Hertz (scalar) drives, as well.

Marathon Motors's "MAX" family, consisting of Blue Max®, Black Max® and microMAX™ motors, have been specifically designed for optimal operation on vector or volts/hertz controls. These motors feature a wide constant torque (up to 2000:1) and/or constant horsepower (up to 4:1) speed range and are performance-matched to all current technology IGBT drives. Vector Duty motors meet or exceed the requirements of NEMA MG1, Part 31, and are equipped with an enhanced insulation system (MAX GUARD® or CR²⁰⁰) to provide many years of trouble-free service. Consult the catalog page for each product's capabilities and features. As these motors are specifically designed for operation through an inverter, they are exempt from EPAAct legislation. Model numbers contain the letter "H" in the "Electrical Type" field.

VARIABLE TORQUE LOADS – Applications include fans, blowers and centrifugal pumps. Torque varies as the square of the speed, and horsepower as the cube of the speed. Operation below base speed significantly lightens the load on the motor. While most variable torque applications do not require the motor to operate below half speed, the motor is fully capable of operation to zero speed. Operation above base speed significantly adds to the load on the motor; therefore, a factory representative must review applications requiring variable torque above base speed. Refer to the application chart found on page 14 for use of general purpose three phase motors on variable frequency drives. Marathon's microMAX™, Black Max® or Blue Max® motors are not necessarily required for operation of variable torque loads. A bypass circuit is often employed in Variable Torque applications. If this device is intended to be used, selection of a NEMA Design B motor is recommended, to withstand the inrush current during across-the-line starting.

CONSTANT TORQUE LOADS – Applications include conveyors, elevators, hoists, extruders, positive displacement pumps, mixers and converting equipment. Torque remains constant throughout the range of operation, and extra care should be taken in the proper application of motors, especially at very low speeds. Most constant torque applications don't require operation below 10:1 (i.e. 6 Hz operation on a 60 Hz motor), but an increasing number of applications historically reserved for servo and/or stepper systems are being served with motors capable of operation beyond 20:1, up to 2000:1 (zero speed, constant torque). Refer to the application chart found on page 17 for use of general purpose three phase motors on variable frequency drives.

Continued on next page.

Variable Speed Operation

CONSTANT TORQUE LOADS (Cont'd.)

Applications requiring greater than 20:1 C.T. are ideal for microMAX™, Black Max® or Blue Max® motors. These motors provide full rated torque within their listed speed range, without exceeding a Class F temperature rating while under inverter power (many operate at Class B). Ratings in this catalog have been developed, based on extensive testing on IGBT inverters, set at a minimum 3 KHz (or equivalent) carrier frequency.

Vector Duty and Inverter Duty motors from Marathon Motors are designed for operation at 150% of rated load for one minute, up to the base speed of the motor (overload capability declines to 100% as the motor reaches maximum constant HP speed). These motors accommodate constant horsepower operation to 1-1/2 to 2 times base speed, subject to the motor's maximum safe mechanical speed limit. Refer to the Maximum Safe Mechanical Speed Chart, as well as the performance section for each motor's capability.

Motors rated for zero RPM continuous duty (1000:1 or 2000:1) must be powered by vector drives to produce rated torque without overheating. Optimum zero speed and low-speed full torque performance may require a closed loop vector drive (with encoder feedback).

CONSTANT HORSEPOWER LOADS – Applications include coil winders, band saws, grinders, and turret lathes. Operation requires the motor to deliver the same horsepower rating, regardless of shaft speed. Torque increases at low speed and decreases at higher speed. Most general purpose motors can deliver constant horsepower up to 1 1/2 times base speed (consult a factory representative to verify performance). However, many constant HP applications require operation to twice base speed, and some, such as coil winders, up to 4 times base speed. microMAX™, Black Max® and Blue Max® motors are designed for 1 1/2 to 2 times base speed, and the Wide CHP motors, found in Marathon's SB371 Catalog, deliver up to 4 times constant horsepower performance.

BEARING CURRENTS – As stated in NEMA MG1-31.4.4.3, to protect a motor from inverter-sourced shaft voltages, either both bearings must be insulated or the motor shaft must be effectively grounded. Marathon Motors offers several effective means to protect the bearings from inverter sourced EDM (electrical discharge machining). A Shaft Grounding device is standard in Blue Max® motors, in frame sizes 444T and larger. Insulating the motor bearings will not prevent damage to bearings of a connected load, and insulated couplings should be employed to protect the load. Adding a ground brush to a motor with insulated bearings will divert motor shaft currents and help protect the bearings of the connected load. At this time, UL policy prohibits the use of ground brushes or insulated bearings in Hazardous Locations (Div 1 & 2, Zones 1, 2, 21 & 22).

The Marathon Solution to Bearing Currents

Any motor with a "-P" behind the catalog number and a "P" footnote features a current mitigation device.



MOTOR GROUNDING - Frames and accessories of all motors must be grounded in accordance with the National Electric Code (NEC) Article 430. Refer to NEC Article 250 for general information on grounding. Proper grounding of inverter-driven motors is essential to protect personnel and livestock from inverter-sourced common mode voltages, which may reach hazardous levels on the frame of ungrounded or poorly grounded motors.

LOW INPUT VOLTAGE – If, due to lower utility supply voltage, the input voltage from the VFD to the motor is lower than the motor's rated voltage, de-rating of the motor's base frequency, horsepower, full load RPM, and constant HP RPM is required. The revised values can be calculated by multiplying by the ratio of the voltage change. For example, to operate a 460 volt motor from an inverter fed by 50 or 60 HZ, 400 volt utility power, the multiplier is 400/460 or 0.87.

The VFD can be reprogrammed to match the new base point values, allowing the motor to provide rated torque at rated current from the new base speed down to its original minimum Constant torque speed. The motor's CHP range will begin at the new base frequency and will be shortened by the same ratio as described above.

OVERSPEED CAPABILITY – Maximum safe mechanical speed capability is a function of bearing size and type, lubrication, rotor balancing technique and specifications, air gap, enclosure, frame construction and connection to the driven load. In addition, consideration must be given to ambient noise levels, as operation above base speed will increase motor noise and vibration, and reduce bearing life. Under no circumstances should bearing hub temperature exceed 100°C. Belted loads should not exceed 60 Hz operating RPM by more than 25% (NEMA "TS" shafts are not suitable for belted loads). Due to external cooling fans, TEFC (and Explosion Proof Fan Cooled) motors are limited to 4000 RPM maximum speed.

Marathon Motors, through extensive testing in our state-of-the-art laboratory and in actual field experience, has developed a number of high speed motors whose maximum safe mechanical speed exceeds the values in the table below. The following table depicts maximum safe speed limits for continuous operation, direct-coupled, non-explosion proof motors, and does not imply constant horsepower capability. Please consult a factory representative for requirements beyond those listed, or for intermittent duty limits.

**Maximum Safe Mechanical Speed Limits
(ODP, TENV, DPFV OR TEBC ENCLOSURES)
60 Hz base frequency**

Frame Size	2-Pole	4, 6 or 8-Pole
56-184	7200	5400
213-256	5400	4200
284-286	5400	3600
324-326	4000	3600
364-365	4000	2800
404-449	3600	2800
5000 Fr	N/A	CALL
6800 Fr	N/A	CALL

Variable Speed Operation

OTHER APPLICATION CONSIDERATION

For proper selection, the following should be considered:

- Horsepower or torque requirements at various speeds.
- Desired speed range of the load and motor.
- Acceleration and deceleration rate requirements of the process being controlled.
- Starting requirements including the frequency of starting and a description of the load (reflected inertia at the motor, load torque during starting).
- Whether the application is a continuous process or duty cycle of starts, stops and speed changes.
- A general description of the type of application including the environment in which the VFD system components must operate (determines motor enclosure and/or explosion proof classification).
- Description of the available electrical power supply and wiring.
- Special performance requirements, if any.
- Whether the drive will be configured with a by-pass circuit. In case of its deployment, the motor will operate like its fixed speed counterpart and may require a NEMA B design which limits in-rush current, or selection of a larger motor starter or other protective circuitry.
- Load sharing
- Mounting and other mechanical considerations

VARIABLE SPEED OPERATION

Typical Temperature Rise Of Various Enclosures

Temp. Rise

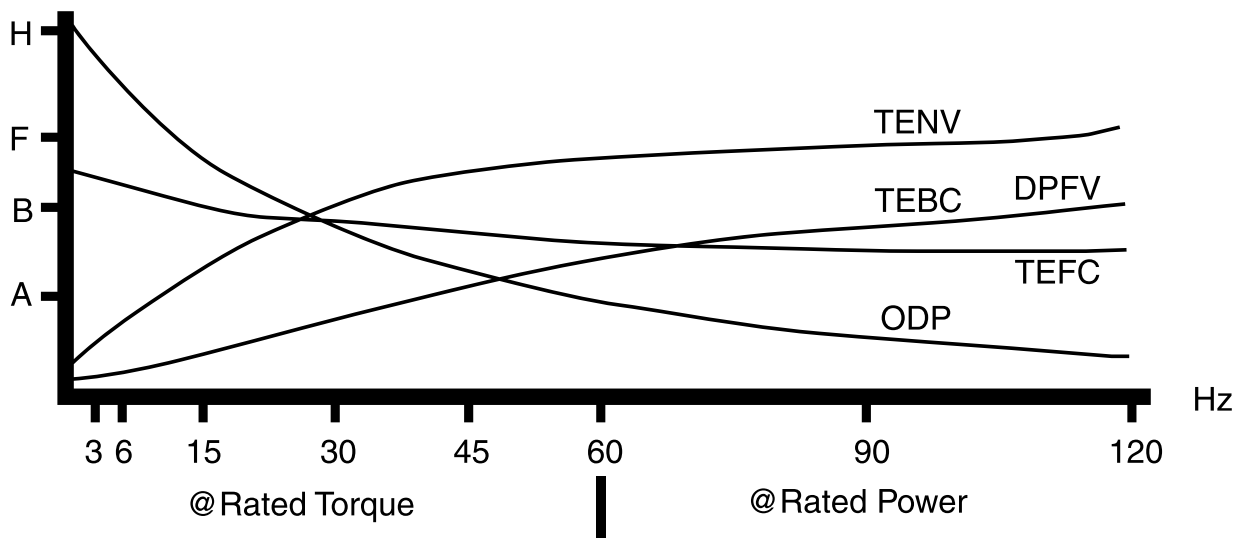

General Purpose, Single Phase (NEMA Service Factor), Dripproof



Features:

- Heavy gauge steel frame and base
- Ball bearings (except as noted)
- Economical split phase or capacitor start designs, as noted
- Service Factor, as noted
- UL Recognized and CSA Certified

Rigid Base

HP	RPM	VOLTS	FRAME	OVER LOAD	CAT. NO.	MODEL NO.	STOCK	LIST PRICE	MULT. SYMB.	F.L. AMPS	WEIGHT	"C" DIM.	FOOT NOTES
1/6	1800	115	48	AUTO	4349	5KH39QN9537X	✓	\$143	F1	3.9	12	8.94	3,20
1/4	1800	115	48	NONE	4354	5KH39QN9538	✓	\$146	F1	5.1	13	8.94	3,20
	1800	115	48	NONE	H239	5KH33FN6	✓	\$197	F1	5.6	13	8.87	d,3,20
	1800	115	48	AUTO	4362	5KH39QN9686X	✓	\$151	F1	5.1	13	8.94	3,20
	1800	115/208-230	48	MANUAL	G078	048C17D2034	✓	\$202	F1	5.0/2.3-2.5	17	9.84	2,20
	1800	115/208-230	48	NONE	C147	5KC35JN10	✓	\$187	F1	5.2/2.7-2.6	16	9.25	2,20
	1800	115/208-230	48	AUTO	C148	5KC35JN10X	✓	\$253	F1	5.2/2.7-2.6	16	9.25	2,20
	1800	115/230	48	AUTO	C145	5KC35JN8X	✓	\$227	F1	5.2/2.6	16	9.57	d,2,20
	1500	110/220	48	NONE	C431	5KC36LN18	✓	\$275	F1	5.6/2.8	17	9.66	2,20,50
1/3	3600	115/208-230	48	NONE	G091	048C34D2025		\$161	F1	4.4/2.2-2.2	17	10.09	2,20
	1800	115/208-230	48	NONE	C153	5KC36LN30	✓	\$268	F1	6.0/3.2-3.0	18	9.66	2,20,68
	1800	115/208-230	48	AUTO	C154	5KC36LN30X	✓	\$280	F1	6.0/3.2-3.0	18	9.66	2,20,68
	1800	115/208-230	56	NONE	C158	5KC36LN7	✓	\$227	F1	6.0/3.2-3.0	18	10.32	2,20,68
	1800	100-120/200-240	56	NONE	E253	5KCR46JN0085	✓	\$327	F1	4.0-3.8/2.0-1.9	23	10.77	ES,1,20,68
	1800	115/208-230	56	AUTO	C159	5KC36LN7X	✓	\$235	F1	6.0/3.2-3.0	18	10.32	2,20,68
	1800	115/208-230	56	MANUAL	G095	056C17D2010	✓	\$242	F1	6.4/3.0-3.2	18	10.22	2,20
	1200	115/230	56	NONE	C1252	5KC49PN6070	✓	\$338	F1	8.6/4.3	89	11.48	2,20,68
1/2	3600	115/230	48	NONE	G1098	5KC36JN266	✓	\$180	F1	7.6/3.8	15	9.66	2,19
	3600	115	56	MANUAL	9031	5KC49MN2043Y	✓	\$215	F1	11.5	20	11.14	2,17
	3600	115/230	56	MANUAL	C1474	5KC37LN502Y	✓	\$265	F1	7.4/3.7	17	10.72	2,17
	3000	110/220	48	NONE	C459	5KC37MN96	✓	\$300	F1	7.8/3.9	20	10.06	2,19,50
	1800	115/230	48	NONE	C164	5KC37NN15	✓	\$332	F1	9.2/4.6	20	10.40	2,19
	1800	110-120/200-240	56	NONE	E262	5KCR46MN0092	✓	\$384	F1	5.8-5.6/2.9-2.8	27	10.77	ES,1,19,68
	1800	115/208-230	56	NONE	C167	5KC49GN0010	✓	\$253	F1	8.8/4.2-4.4	21	10.38	2,19
	1800	115/230	56	AUTO	C168	5KC49GN0010X	✓	\$277	F1	8.8/4.4	21	10.38	2,19
	1800	115/230	56	MANUAL	C169	5KC49GN0010Y	✓	\$284	F1	8.8/4.4	31	10.38	2,19
	1200	115/230	56	NONE	C1263	5KC48UN6073	✓	\$433	F1	9.4/4.7	34	12.76	2,19
3/4	3600	115/208-230	56	NONE	G915	056C34D2100	✓	\$233	F1	9.6/4.4-4.8	21	10.97	2,19
	3600	115	56	MANUAL	9032	5KC49MN2049Y	✓	\$250	F1	12.5	27	11.14	2,17
	3600	115/230	56	MANUAL	C1475	5KC37NN501Y	✓	\$321	F1	10.2/5.1	18	10.72	2,19
	1800	100-120/200-240	56	NONE	EG271	5KCR49PN0097	✓	\$482	F1	9.0-8.8/4.5-4.4	31	11.37	ES,1,19,68
	1800	115/208-230	56	NONE	C175	5KC46LN0153	✓	\$317	F1	13.2/6.2-6.6	25	10.78	2,19
	1800	115/230	56	AUTO	C176	5KC46LN0153X	✓	\$366	F1	13.2/6.6	24	10.78	2,19
	1800	115/208-230	56	MANUAL	G919	056B17D2010	✓	\$346	F1	11.0/5.5-5.5	26	11.47	1,19
	1800	115/208-230	56	MANUAL	C1298	5KC46NN0758Y	✓	\$346	F1	11.2/5.8-5.6	26	10.34	2,19
	1800	115/230	56	MANUAL	C177	5KC46LN0153U	✓	\$388	F1	13.2/6.6	24	10.78	d,2,19
	1200	115/230	56	NONE	C178	5KCR49VN6075	✓	\$554	F1	12.6/6.3	44	13.96	ES,1,18
1	3600	115/208-230	56	NONE	C179	5KC38RN60	✓	\$264	F1	12.4/6.4-6.2	24	11.04	2,19
	3600	115/208-230	56	AUTO	C180	5KC38RN60X	✓	\$338	F1	12.4/6.4-6.2	24	11.04	2,19
	3600	115/230	56	MANUAL	9033	5KC49NN2050Y	✓	\$285	F1	16.0/8.0	23	11.14	d,2,17
	3600	115/208-230	56	MANUAL	D010	056B34D2029	✓	\$287	F1	10.6/5.5-5.3	23	11.72	1,18
	3600	115/230	56	MANUAL	C702	5KC38RN4153Y	✓	\$407	F1	12.8/6.5	20	11.04	d,2,18
	1800	100-120/200-240	56H	NONE	E280	5KCR48UN0104	✓	\$343	F1	11.8-11.4/5.9-5.7	39	12.66	ES,1,18
	1800	115/208-230	56	NONE	C181	5KC49PN0161	✓	\$343	F1	13.6/6.7-6.8	31	11.38	2,18
	1800	115/208-230	56	AUTO	C182	5KC49PN0161X	✓	\$365	F1	13.6/6.6-6.8	31	11.38	2,18
	1800	115/230	56	MANUAL	C1480	5KC49PN0161U	✓	\$379	F1	13.6/6.8	31	11.38	2,18
	1800	115/208-230	143T	NONE	C188	5KC49PN0162	✓	\$343	S1	13.6/6.7-6.8	31	11.77	2,11,18
	1200	115/230	56H	NONE	C183	5KCR49QN6076	✓	\$499	F1	12.6/6.3	54	14.93	ES,1,18
	1200	115/230	182T	NONE	I141	182TCDR17079		\$574	S1	15.0/7.5	87	15.72	13,18

SINGLE PHASE

Continued on next page.

General Purpose, Single Phase (NEMA Service Factor), Dripproof



Rigid Base

HP	RPM	VOLTS	FRAME	OVER LOAD	CAT. NO.	MODEL NO.	STOCK	LIST PRICE	MULT. SYMB.	F.L. AMPS	WT.	"C" DIM.	FOOT NOTES
1 1/2	3600	115/208-230	56	NONE	G937	056B34D2026	✓	\$353	F1	14.8/8.0-7.4	25	11.72	1,18
	3600	115/230	56	MANUAL	C1477	5KC49PN2144Y	✓	\$463	F1	16.8/8.4	29	11.82	d,2,18
	3600	115/230	56	MANUAL	C704	5KC49PN2521Y	✓	\$369	F1	21.3 / 10.6	31	11.91	2,18
	3600	115/208-230	143T	NONE	I101	143TCDR5303		\$366	S1	18.8/9.7-9.4	30	10.99	2,14,18
	1800	115/230	56	NONE	C1299	5KCR48WN0756Y		\$443	F1	13.4/6.7	35	12.45	ES,1,110
	1800	115/208-230	56H	MANUAL	G951	056C17D5308	✓	\$443	F1	18.0/9.3-9.0	39	12.44	2,14,18
	1800	115/208-230	56H	NONE	C185	5KCR49SN0068	✓	\$408	F1	18.2/9.1-9.1	35	11.90	ES,1,18
	1800	115/208-230	56H	AUTO	C186	5KCR49SN0068X	✓	\$424	F1	18.2/9.1	35	11.90	ES,1,18
	1800	115/208-230	145T	NONE	C191	5KCR49SN0065	✓	\$415	S1	18.2/9.1-9.1	35	12.30	ES,1,18
	1200	115/230	184T	NONE	I142	184TCDR7076		\$714	S1	23.0/11.5	72	15.72	2,13,18
2	3600	115/230	56	NONE	C187	5KC48TN2169	✓	\$424	F1	21.2 / 10.6	38	12.66	2,18
	3600	115/230	56	MANUAL	C703	5KC49RN2520Y	✓	\$579	F1	23.8/11.8	33	11.91	2,18
	3600	115/208-230	145T	NONE	I102	145TBDR5302	✓	\$436	S1	19.2/10.5-9.6	35	11.49	1,18
	1800	115/208-230	56HZ	NONE	C193	5KCR49WN0270	✓	\$433	F1	22.0/10.9-11.0	44	14.33	ES,1,11,18
	1800	115/208-230	56HZ	AUTO	CG381	5KCR49WN0270T	✓	\$556	F1	22.0/10.9-11.0	44	14.33	ES,1,11,18
	1800	115/208-230	145T	MANUAL	I127	145TBDR5337	✓	\$534	S1	18.8/10.2-9.4	48	13.49	1,11,18
	1800	115/208-230	182T	NONE	I112A	182TCDW7026	✓	\$484	S1	23.0/12.3-11.5	62	13.19	2,13,18
	1200	115/208-230	213T	NONE	I143	213TCDW7076	✓	\$887	S1	30.0/15.5-15.0	138	16.55	2,18
3	3600	230	56	MANUAL	9036	5KCR48UN2653Y	✓	\$602	F1	14.5	40	12.64	ES,1,17,48
	3600	115/230	145T	NONE	C194	5KCR48TN8062	✓	\$610	S1	29.4/14.7	38	13.13	ES,1,18
	3600	115/208-230	182T	NONE	I103A	182TCDW7001	✓	\$544	S1	32.0/17.1-16.1	62	13.69	2,13,18
	1800	115/208-230	184T	NONE	I113A	184TCDW7026	✓	\$566	S1	33.5/17.4-16.8	78	14.21	2,13,18
	1200	230	215T	NONE	I144	215TBDW7079		\$1,222	S1	16.0	134	18.05	1,18
5	3600	230	56H	MANUAL	D017	056B34D5302	✓	\$640	F1	20.0	55	13.94	1,5,18
	3600	208-230	184T	NONE	I104A	184TBDW17008	✓	\$731	S1	24.0-22.0	79	14.69	2,13,18
	1800	208-230	184T	NONE	I114A	184TBDW7026	✓	\$686	S1	23.0-21.0	82	14.71	1,13,18
	1800	208-230	213T	NONE	I117	213TCDW7026		\$934	S1	30.5-28.0	108	16.55	2,18
7 1/2	3600	208-230	184T	NONE	I108A	184TBDW7001	✓	\$770	S1	34.0-31.0	103	16.69	1,13,18
	3600	208-230	213T	NONE	I105	213TCDW7001	✓	\$1,041	S1	40.0-37.0	105	16.55	2,18,F
	1800	208-230	215T	NONE	I115	215TBDW7026	✓	\$1,027	S1	37.2-34.5	115	18.05	1,18
10	3600	208-230	215T	NONE	I106	215TCDW17002	✓	\$1,335	S1	51.0-46.0	193	18.05	2,18,F
	1800	208-230	215T	NONE	I116	215TBDW7028	✓	\$1,322	S1	49.0-44.0	140	19.30	1,7,18

SINGLE PHASE

Extended Thru-Bolts, Split Phase - Steel Endshields

HP	RPM	VOLTS	FRAME	OVER LOAD	CAT. NO.	MODEL NO.	STOCK	LIST PRICE	MULT. SYMB.	F.L. AMPS	WT.	"C" DIM.	FOOT NOTES
1/4	1800	115	48Z	NONE	H901	5KH32DNA612	✓	\$126	F1	5.1	11	9.83	9,18,28
	1800	115	48Z	AUTO	H902	5KH32DNA612X	✓	\$131	F1	5.1	11	9.83	9,18,28
1/3	1800	115	48Z	NONE	H903	5KH32FNA611	✓	\$130	F1	5.5	14	9.83	9,18,28
	1800	115	48Z	AUTO	H904	5KH32FNA611X	✓	\$135	F1	5.5	12	9.83	9,18,28
1/2	1800	115	56Z	NONE	H905	5KH36JNA769	✓	\$153	F1	8.1	16	10.89	10,18,28
	1800	115	56Z	AUTO	H906	5KH36JNA769X	✓	\$158	F1	8.1	16	10.89	10,18,28
3/4	1800	115	56Z	NONE	H907	5KH37NNA768	✓	\$187	F1	11.2	18	11.29	10,17
	1800	115	56Z	AUTO	H908	5KH37NNA768X	✓	\$192	F1	11.2	33	11.29	10,17

Special Purpose, Single Phase (1.0 Service Factor), Dripproof

Features:

- Heavy gauge steel frame and base
- Ball bearings (except as noted)
- Economical split phase or capacitor start designs, as noted
- 1.0 Service Factor
- UL Recognized and CSA Certified



Rigid Base

HP	RPM	VOLTS	FRAME	OVER LOAD	CAT. NO.	MODEL NO.	STOCK	LIST PRICE	MULT. SYMB.	F.L. AMPS	WT.	"C" DIM.	FOOT NOTES
1/4	1800	115	48	NONE	4351	5KH39QN9542	✓	\$112	F1	5.7	13	8.94	d,3
	1800	115	48	NONE	S003	048S17D2089	✓	\$112	F1	5.7	12	9.09	3
	1500	110/220	48	AUTO	H689	5KH35JN603X	✓	\$230	F1	5.2/2.6	15	9.23	3,50
1/3	1800	115	48	AUTO	4380	5KH39QN9681X	✓	\$161	F1	6.2	14	8.94	d,3,4
	1800	115	48	AUTO	S026	048S17D2113	✓	\$130	F1	6.6	14	9.34	3
	1800	115	48	NONE	4368	5KH39QN9397		\$125	F1	6.2	14	8.94	3
	1800	115	48	NONE	S006	048S17D2090	✓	\$125	F1	6.6	14	9.34	3
	1800	115	48	NONE	H229	5KH35HN9		\$204	F1	6.8	15	9.25	3
	1800	115/230	48	NONE	S010	048C17D2023	✓	\$169	F1	7.0/3.5	15	9.34	2
	1800	115/230	48	MANUAL	S030	048C17D2027	✓	\$202	F1	7.0/3.5	16	9.34	2
	1800	115/230	48	AUTO	S011	048C17D2024	✓	\$177	F1	7.0/3.5	16	9.34	
	1800	230	48	NONE	4373	5KH39QN9543	✓	\$176	F1	3.3	14	8.94	3
	1800	115	48Z	NONE	4376	5KH39QN9547		\$168	F1	6.2	15	10.36	3,21
	1800	115	56Z	NONE	4372	5KH39QN9546	✓	\$172	F1	6.2	15	8.94	3,7
	1800	115	56Z	NONE	H676	5KH35GNA229	✓	\$204	F1	6.2	14	9.57	3,7
	1800	115/230	56	MANUAL	CG105	5KC35JN27Y		\$242	F1	6.6/3.3	16	9.89	2
	1500	110/220	48	AUTO	H691	5KH36LN488X	✓	\$246	F1	7.0/3.5	17	9.66	3,7
	1/2	1800	115	48	NONE	H696	5KH36LNA504	✓	\$243	F1	8.3	15	9.68
1800		115	56	AUTO	9029	5KC49NN0221X	✓	\$219	F1	8.7	20	11.14	2
1800		115	56	AUTO	S027	056S17D2066	✓	\$166	F1	9.2	19	10.22	3
1800		115	56	NONE	H230	5KH39QN9091		\$159	F1	8.3	16	10.32	3,7
1800		115	56	NONE	S022	056S17D2046	✓	\$159	F1	9.2	17	10.22	3
1800		115/230	56	NONE	S012	056C17D2098	✓	\$208	F1	9.2/4.6	18	10.22	2
1800		115/230	56	MANUAL	S033	056C17D2064	✓	\$242	F1	9.2/4.6	18	10.22	2
1800		115/230	56	AUTO	S013	056C17D2051	✓	\$217	F1	9.2/4.6	18	10.22	2
1800		115/230	56Z	NONE	CG393	5KC36MN20	✓	\$292	F1	8.2/4.1	17	12.30	2
3/4		3600	115/230	48	NONE	CG111	5KC37LN91	✓	\$416	F1	11.2/5.6	19	10.06
	1800	115/230	56	MANUAL	S036	056C17D2067	✓	\$284	F1	10.4/5.2	24	11.97	2
	1800	115/230	56	AUTO	S015	056C17D2055	✓	\$259	F1	10.4/5.2	24	11.97	2
	1800	115/230	56	NONE	S014	056C17D2054	✓	\$249	F1	10.4/5.2	24	11.97	2
1	3600	115/230	56Z	NONE	C449	5KC37NN160	✓	\$327	F1	13.4/6.7	20	12.60	2
	1800	115/230	56	MANUAL	S039	056C17D5320	✓	\$369	F1	13.6/6.8	27	10.94	2
	1800	115/230	56	AUTO	S038	056C17D5343	✓	\$343	F1	13.6/6.8	27	10.94	2
	1800	115/230	56	NONE	S037	056C17D5319	✓	\$335	F1	13.6/6.8	28	10.94	2
1 1/2	3600	115/230	56	MANUAL	9034	5KC49NN2044Y	✓	\$281	F1	19.0/9.5	29	11.14	2
2	3600	115/230	56	MANUAL	9035	5KCR48TN2650Y	✓	\$462	F1	17/8.5	38	12.76	ES,1,48
3	3600	208-230	145T	NONE	I145	145TBDR5303		\$472	S1	13.5/12.5	40	12.49	1
5	3600	230	56H	MANUAL	9038B	5KCR49ZN2722Y	✓	\$640	F1	21.0	49	15.04	ES,1,48

SINGLE PHASE

Fan and Blower Duty, Single Phase (NEMA Service Factor), Dripproof

Features:

- Heavy gauge steel frame and base
- Ball bearings (except as noted)
- Thermal protection, as noted
- Capacitor start design for high starting torque
- Capacitor start/capacitor run design for higher efficiency, as noted
- 48Y and 48YZ have 48/56 Fr mounting holes
- Service Factor, as noted
- UL Recognized and CSA Certified



Resilient Base

HP	RPM	VOLTS	FRAME	OVER LOAD	CAT. NO.	MODEL NO.	STOCK	LIST PRICE	MULT. SYMB.	F.L. AMPS	WT.	"C" DIM.	FOOT NOTES
1/4	1800	115	48	AUTO	CG201	5KC35JN12X	✓	\$223	F1	5.2	16	9.57	d,4,20
	1800	115	48	NONE	C200	5KC35JN12	✓	\$218	F1	5.2	16	9.57	d,20
	1800	115/230	48	NONE	G1114	5KC35JN7	✓	\$173	F1	5.2/2.6	16	9.57	20
	1800	115/230	48	AUTO	G1115	5KC35JN7X	✓	\$183	F1	5.2/2.6	16	9.57	20
	1500	110/220	48	AUTO	C460	5KC36LN19X	✓	\$281	F1	5.6/2.8	18	10.00	20,50
1/3	3600	115/230	48	AUTO	C208	5KC35FN51X	✓	\$237	F1	6.8/3.4	15	9.57	20
	1800	100-120/200-240	56	AUTO	E254	5KCR46JN0086X	✓	\$337	F1	4.0-3.8/2.0-1.9	25	10.77	ES,1,20,68
	1800	115/208-230	48	NONE	C209	5KC36LN26	✓	\$269	F1	6.0/3.2-3.0	18	10.00	20,68
	1800	115/208-230	48	AUTO	C210	5KC36LN26X	✓	\$284	F1	6.0/3.2-3.0	18	10.00	20,68
	1800	115/230	56	AUTO	G135	056C17D2088	✓	\$221	F1	6.4/3.2	18	10.22	20
	1800	115/208-230	56	NONE	C215	5KC36LN1	✓	\$292	F1	6.0/3.2-3.0	18	10.32	20,68
	1800	115/208-230	56	AUTO	C216	5KC36LN1X	✓	\$241	F1	6.0/3.2-3.0	18	10.32	20,68
	1500	110/220	56	AUTO	C457	5KC37NN14T	✓	\$341	F1	7.4/3.7	20	10.72	20,50
	1200	115/230	56	NONE	C1258	5KC49PN6051	✓	\$396	F1	8.6/4.3	28	11.38	20
	1200	115/230	56	AUTO	C548	5KC49PN6051X	✓	\$407	F1	8.6/4.3	28	11.38	20
1/2	3600	115/208-230	48	AUTO	C1152	5KC39QN3220X	✓	\$175	F1	8.2/3.9-4.1	19	11.00	19
	1800	100-120/200-240	56	AUTO	E263	5KCR46MN0054X	✓	\$403	F1	5.8-5.6/2.9-2.8	27	10.77	ES,1,19,68
	1800	115/208-230	56	NONE	B1316	5KC49GN0001	✓	\$259	F1	8.8/4.2-4.4	21	10.38	19
	1800	115/208-230	56	AUTO	C1153	5KC49GN0022X	✓	\$293	F1	8.6/4.1-4.3	21	10.38	19
	1800	115/208-230	56	AUTO	B317	056C17D2072	✓	\$299	F1	8.0/4.1-4.0	20	10.47	CF,19,31
	1800	115/230	56	AUTO	CG223	5KC49GN0001X	✓	\$314	F1	8.8/4.4	21	10.38	19
	1800	115/230	56	AUTO	D111	056C17D2079	✓	\$263	F1	7.2/3.6	20	10.72	19
	1800	115/230	56	AUTO	G151	056C17D2025	✓	\$263	F1	8.6/4.3	24	11.72	19
	1200	115/230	56	NONE	C1264	5KC48UN6052	✓	\$564	F1	9.4/4.7	40	12.76	19
	1200	115/230	56	AUTO	C552	5KC48UN6052X	✓	\$576	F1	9.4/4.7	36	12.76	19
3/4	3600	115/208-230	48	AUTO	C1154	5KC38NN413X	✓	\$322	F1	10.0/4.9-5.0	17	11.00	19
	3600	115/208-230	56	AUTO	C1155	5KC38NN410X	✓	\$228	F1	10.0/4.9-5.0	17	11.32	19
	1800	100-120/200-240	56	AUTO	EG272	5KCR49PN0098X	✓	\$501	F1	9.0-8.8/4.5-4.4	31	11.37	ES,1,17,68
	1800	115/208-230	56	NONE	G156	056B17D2012	✓	\$324	F1	11.0/5.5-5.5	26	11.47	1,19
	1800	115/208-230	56	AUTO	C1156	5KC46LN0149X	✓	\$353	F1	13.3/6.5-6.6	27	10.78	19
	1800	115/208-230	56	AUTO	B319	056C17D2074	✓	\$363	F1	10.0/5.2-5.0	23	11.72	CF,19,31
	1800	115/208-230	56	NONE	CG230	5KC46LN0158	✓	\$326	F1	13.2/6.2-6.6	25	10.78	19
	1800	115/208-230	56	NONE	B318	056C17D2073	✓	\$337	F1	10.0/5.2-5.0	24	11.72	CF,19,31
	1800	115/208-230	56	AUTO	C138	5KC46JN0002X	✓	\$352	F1	11.4/5.6-5.7	23	10.78	19
	1800	115/230	56	AUTO	D1113	5KC46LN0158X	✓	\$325	F1	13.2/6.6	25	10.78	d,19
	1500	110/220	56	AUTO	C1187	5KC49NN0224X	✓	\$463	F1	12.2/6.1	28	11.38	19,50
	1200	115/230	56	NONE	CG232	5KCR49WN6077	✓	\$652	F1	12.6/6.3	42	13.96	1,18
1	3600	115/208-230	56	AUTO	C1157	5KC39RN383X	✓	\$284	F1	13.4/6.7-6.6	25	11.90	19
	3600	115/208-230	56	AUTO	D118	056C34D2106	✓	\$266	F1	12.0/6.2-6.0	25	12.22	18
	1800	100-120/200-240	56H	AUTO	E281	5KCR48UN0105X	✓	\$526	F1	11.8-11.4/5.9-5.7	40	12.65	ES,1,18,68
	1800	115/208-230	56	AUTO	C1158	5KC49PN0164X	✓	\$369	F1	14.7/7.2-7.4	29	11.38	18
	1800	115/208-230	56	NONE	C235	5KC49PN0155	✓	\$344	F1	13.6/6.7-6.8	31	11.38	5,18
	1800	115/230	56	AUTO	CG236	5KC49PN0155X	✓	\$418	F1	13.6/6.8	30	11.38	18

Continued on next page.

Fan and Blower Duty, Single Phase (NEMA Service Factor), Dripproof

Resilient Base

HP	RPM	VOLTS	FRAME	OVER LOAD	CAT. NO.	MODEL NO.	STOCK	LIST PRICE	MULT. SYMB.	F.L. AMPS	WT.	"C" DIM.	FOOT NOTES
1 1/2	3600	115/208-230	56H	AUTO	C1159	5KC49RN2152T		\$370	F1	19.6/9.8-9.8	33	12.01	18
	3600	115/208-230	56	AUTO	D115	056B34D2027		\$370	F1	13.4/7.4-6.7	28	11.72	1,18
	1800	115/208-230	56H	NONE	B336	056C17D5347	✓	\$413	F1	18.0/9.3-9.	39	12.85	2,5,18,32
	1800	115/208-230	56H	AUTO	CG239	5KCR49SN0012X	✓	\$491	F1	18.2/9.1	35	11.91	ES,1,5,18
	1800	115/208-230	56H	AUTO	C1160	5KCR49SN0150X	✓	\$429	F1	16.4/8.4-8.2	35	11.90	ES,1,18
	1800	115/208-230	145T	NONE	I146	145TCDR5331	✓	\$419	S1	18.0/9.3-9.	42	13.22	2,18,32
2	3600	115/208-230	56H	AUTO	K152	056B34D5320	✓	\$450	F1	19.2/10.5-9.6	33	11.85	1,5,18
	3600	115/208-230	56H	AUTO	C1161	5KCR49RN2148T	✓	\$451	F1	19.6/10.4-9.8	33	11.91	ES,1,5,110
	1800	115/208-230	56H	AUTO	B352	056B17D5331	✓	\$547	F1	21.0/11.3-10.5	50	13.85	1,5,18
	1800	115/208-230	145T	NONE	I147	145TBDR5345	✓	\$440	S1	21/11.3-10.5	49	14.22	1,18

Two Speed, Variable Torque, Resilient Base

HP	RPM	VOLTS	FRAME	OVER LOAD	CAT. NO.	MODEL NO.	STOCK	LIST PRICE	MULT. SYMB.	F.L. AMPS	WT.	"C" DIM.	FOOT NOTES
1/2-1/6	1800/1200	115	56	AUTO	C419	5KC49PN3027X	✓	\$499	F1	8.2/3.9	28	11.38	2,19
3/4-1/4	1800/1200	115	56	AUTO	C474	5KCR49PN3011X	✓	\$545	F1	9.0/6.4	31	11.48	ES,1,19
	1800/1200	115	56	NONE	C420	5KCR49PN3011	✓	\$463	F1	9.0/6.4	31	11.48	ES,1,19
	1800/1200	208-230	56	AUTO	C486	5KCR49PN3012X	✓	\$472	F1	4.3-4.4/3.1-3.2	38	11.48	ES,1,19
1 1/3	1800/1200	115	56	AUTO	C1478	5KCR49SN3009X	✓	\$601	F1	10.8/7.4	30	12.01	ES,1,18
	1800/1200	115	56	NONE	C475	5KCR49SN3009	✓	\$578	F1	10.8/7.4	35	12.01	ES,1,18
	1800/1200	208-230	56	NONE	C476	5KCR49SN3010	✓	\$601	F1	5.3-5.4/3.6-3.7	35	12.01	ES,1,18
	1800/1200	208-230/ 190-220	56H	AUTO	C1479	5KCR48TN3084X	✓	\$613	F1	5.3-5.4/3.6-3.7	36	12.54	ES,1,17

Fan and Blower Duty, Single Phase (1.0 Service Factor), Dripproof

Features:

- Heavy gauge steel frame and base
- Ball bearings (except as noted)
- 1.0 Service Factor
- Economical split phase or capacitor start designs, as noted
- 48Y and 48YZ have 48/56 Fr mounting holes
- UL Recognized and CSA Certified



SINGLE PHASE

Resilient Base

HP	RPM	VOLTS	FRAME	OVER LOAD	CAT. NO.	MODEL NO.	STOCK	LIST PRICE	MULT. SYMB.	F.L. AMPS	WT.	"C" DIM.	FOOT NOTES
1/4	1800	115	48	AUTO	S103	048S17D2091		\$125	F1	5.7	13	9.06	3,7,31
	1800	115	48	NONE	S102	048S17D2042	✓	\$119	F1	5.7	13	9.06	3,7
	1800	115/230	48	AUTO	S119	048C17D2046	✓	\$173	F1	6.2/3.1	13	9.06	2,7
	1800	115/230	48	NONE	S118	048C17D2045	✓	\$164	F1	6.2/3.1	14	9.06	2,7
	1800	115	48	NONE	H675	5KH33FNA230	✓	\$197	F1	5.0	14	9.19	d,3,7
	1800	115	48Z	AUTO	S126	048S17D2104	✓	\$125	F1	5.3	14	9.72	3,53
	1800	115	56Z	AUTO	4364	5KH39QN5541X	✓	\$169	F1	5.7	13	9.19	3,4,7
	1800	115	56Z	NONE	4359	5KH39QN5523	✓	\$165	F1	5.7	13	9.19	3,4,7
	1500	220	48	NONE	H645	5KH39QN810	✓	\$223	F1	3.4	14	9.57	3,7,50
	1500	110/220	56Z	AUTO	HG690	5KH35JN602X	✓	\$237	F1	5.2/2.6	15	9.51	3,7,50

Continued on next page.

Fan and Blower Duty, Single Phase

(1.0 Service Factor), Dripproof

Resilient Base

HP	RPM	VOLTS	FRAME	OVER LOAD	CAT. NO.	MODEL NO.	STOCK	LIST PRICE	MULT. SYMB.	F.L. AMPS	WEIGHT	"C" DIM.	FOOT NOTES	
1/3	1800	115	48	NONE	4369	5KH39QN5508	✓	\$139	F1	6.2	14	8.94	3	
	1800	115	48	NONE	S106	048S17D2093	✓	\$141	F1	6.5	14	9.31	3,31,CF	
	1800	115/230	48	AUTO	C129	5KC35JN23X	✓	\$183	F1	6.4/3.2	16	9.57	2	
	1800	115/230	48	AUTO	S111	048C17D2029	✓	\$183	F1	7.0/3.5	16	9.31	2	
	1800	115/230	48	NONE	S110	048C17D2028	✓	\$173	F1	7.0/3.5	16	9.31	2	
	1800	115	48	AUTO	4310	5KH39QN5508X	✓	\$137	F1	6.2	14	8.94	3	
	1800	115	48Y	AUTO	S127	048S17D2105	✓	\$137	F1	6.6	14	9.72	3,53	
	1800	115	48	NONE	H674	5KH35JNA231	✓	\$212	F1	6.6	15	9.57	3	
	1800	115	56Z	NONE	4377	5KH39QN5524	✓	\$180	F1	6.2	15	9.19	3,7	
	1800	115	56Z	AUTO	4381	5KH39QN5528X	✓	\$184	F1	6.2	15	9.19	3,7	
	1800	115	56Z	AUTO	4776	5KH39QN5539T	✓	\$184	F1	6.2	16	9.19	d,3,7,57	
	1800	230	48	NONE	4371	5KH39QN5529	✓	\$180	F1	3.3	14	8.94	3	
	1800	230	48	AUTO	4311	5KH39QN5529X	✓	\$184	F1	3.3	14	8.93	3	
	1500	110/220	56Z	AUTO	HG692	5KH36LN489X	✓	\$254	F1	7.0/3.5	17	9.94	3,50	
	1500	220	56Z	NONE	H673	5KH33KN5594	✓	\$242	F1	3.5	17	9.19	3,7,50	
1/2	1800	115	48Z	AUTO	HG710	5KH33JNA511T	✓	\$166	F1	7.9	15	9.93	3,9	
	1800	115	48Z	AUTO	S128	048S17D2106	✓	\$166	F1	9.2	17	10.22	3,53	
	1800	115	56	NONE	S120	056S17D2023	✓	\$164	F1	9.2	18	10.22	3,31	
	1800	115	56Z	AUTO	4778	5KH39QN9639T	✓	\$254	F1	8.3	20	9.57	3,7	
	1800	115/230	56Z	AUTO	S113	056C17D2099	✓	\$221	F1	9.1/4.5	19	10.22	2	
	1800	115/230	56	NONE	S112	056C17D2097	✓	\$213	F1	9.1/4.5	19	10.22	2	
	1800	115/230	48	AUTO	C133	5KC36MN27X	✓	\$308	F1	8.2/4.1	19	10.00	2	
	1800	230	56	AUTO	4602	5KH39QN9518X	✓	\$275	F1	4.2	19	10.32	3	
	1800	230	56	NONE	4387	5KH39QN9684	✓	\$267	F1	4.2	19	10.32	3	
	1500	110/220	56	AUTO	H693	5KH46JN0329X	✓	\$283	F1	9.2/4.6	23	10.55	3	
	3/4	1800	115/230	56	NONE	S114	056C17D2060	✓	\$253	F1	10.4/5.2	25	11.97	2
		1800	115	56	NONE	4422	5KH39QN9687	✓	\$314	F1	11.2	21	10.72	3
1800		115/230	56	AUTO	C1483	5KC46LN0254X	✓	\$263	F1	13.2/6.6	25	10.78	2	
1800		115/230	56	AUTO	S115	056C17D2061	✓	\$263	F1	10.4/5.2	25	11.97	2	
1	1800	115/230	56	AUTO	S117	056C17D5340	✓	\$348	F1	13.6/6.8	28	11.35	2	
	1800	115/230	56	NONE	S116	056C17D5339	✓	\$339	F1	13.6/6.8	29	11.35	2	

SINGLE PHASE

General Purpose, Single Phase (NEMA Service Factor), Dripproof



Features:

- Ball bearings mechanically locked on shaft end (excludes 5K models)
- Heavy gauge steel frame and base
- Capacitor start design for high starting torque
- Capacitor start/capacitor run design for higher efficiency, as noted
- Service Factor, as noted
- UL Recognized and CSA Certified

C-Face Footless

HP	RPM	VOLTS	FRAME	OVER LOAD	CAT. NO.	MODEL NO.	STOCK	LIST PRICE	MULT. SYMB.	F.L. AMPS	WEIGHT	"C" DIM.	FOOT NOTES
1/4	1800	115/208-230	56C	NONE	G212	056C17D2084	✓	\$202	F1	5.0/2.3-2.5	17	10.69	20
	1800	115/208-230	56C	AUTO	C354	5KC35JN70X	✓	\$265	F1	5.2/2.7-2.6	15	9.61	20
1/3	3600	115/208-230	56C	NONE	G216	056C34D2117	✓	\$173	F1	4.4/2.2-2.2	17	10.19	20
	1800	100-120/200-240	56C	NONE	E251	5KCR46JN0084	✓	\$390	F1	4.0-3.8/2.0-1.9	23	10.77	ES,1,20,68
	1800	115/208-230	56C	AUTO	C356	5KC36LN83X	✓	\$307	F1	6.0/3.2-3.0	16	10.35	20,68
1/2	1800	115/208-230	56C	NONE	G230	056C17D2085	✓	\$237	F1	6.4/3.0-3.2	17	10.69	20
	3600	115/208-230	56C	NONE	G232	056C34D2108	✓	\$191	F1	8.4/3.8-4.2	17	10.69	19
	1800	100-120/200-240	56C	NONE	E260	5KCR46MN0091	✓	\$445	F1	5.8-5.6/2.9-2.8	25	10.77	ES,1,19,68
	1800	115/208-230	56C	NONE	G234	056C17D2044	✓	\$279	F1	8.6/4.1-4.3	21	11.19	19
	1800	115/230	56C	AUTO	C359	5KC49GN0009X	✓	\$348	F1	8.8/4.4	21	10.38	19
3/4	1200	115/208-230	56C	NONE	G278	056C11D5304	✓	\$446	F1	10.6/5.1-5.3	32	11.94	19
	1200	115/230	56C	NONE	C1422	5KC48UN6072	✓	\$483	F1	9.4/4.7	40	12.61	19
	3600	115/208-230	56C	NONE	G238	056C34D2101	✓	\$245	F1	9.6/4.4-4.8	20	10.94	19
	1800	100-120/200-240	56C	NONE	E269	5KCR49PN0096	✓	\$482	F1	9.0-8.8/4.5-4.4	31	11.38	ES,1,19,68
	1800	115/230	56C	AUTO	CG362	5KC46LN0159X	✓	\$419	F1	13.2/6.6	24	10.78	19
	1800	115/208-230	56C	NONE	G250	056B17D2011	✓	\$342	F1	11.0/5.5-5.5	25	11.72	1,19
1	3600	115/208-230	56C	NONE	G254	056B34D2031	✓	\$281	F1	10.6/5.5-5.3	23	11.68	1,19
	1800	100-120/200-240	56C	NONE	E278	5KCR48UN0103	✓	\$555	F1	11.8-11.4/5.9-5.7	37	12.65	ES,1,18,68
	1800	115/230	56C	AUTO	CG363	5KC49PN0163X	✓	\$468	F1	13.6/6.8	24	11.38	18
1 1/2	1800	115/208-230	56C	NONE	G256	056C17D5310	✓	\$367	F1	13.4/6.8-6.7	29	11.44	18
	3600	115/208-230	56C	NONE	G258	056B34D2023		\$365	F1	14.2/7.7-7.1	26	11.68	1,18
2	1800	115/208-230	56C	NONE	G270	056C17D5311	✓	\$427	F1	18.0/9.3-9.0	39	12.44	18
	3600	115/208-230	56C	NONE	G272	056B34D5319	✓	\$447	F1	19.2/10.5-9.6	32	11.44	1,18
3	1800	115/208-230	56C	NONE	G274	056B17D5303	✓	\$521	F1	21.0/11.3-10.5	47	13.44	1,18
	3600	115/208-230	182TC	NONE	C173	182TCDR8007		\$598	S1	32.0/17.5-16.0	76	13.96	18
	1800	115/230	184TC	NONE	C174	184TCDR9627		\$584	S1	33.0/16.5	52	15.96	18

SINGLE PHASE

General Purpose, Single Phase (NEMA Service Factor), Dripproof

Features:

- Ball bearings, mechanically locked on shaft end (excludes 5K models)
- NEMA Service Factors
- Heavy gauge steel frame and base
- Capacitor start design for high starting torque
- Capacitor start/capacitor run design for higher efficiency, as noted
- UL Recognized and CSA Certified



C-Face Footed (Rigid Base)

HP	RPM	VOLTS	FRAME	OVER LOAD	CAT. NO.	MODEL NO.	STOCK	LIST PRICE	MULT. SYMB.	F.L. AMPS	WT.	"C" DIM.	FOOT NOTES
1/4	1800	115/208-230	56C	AUTO	K234	056C17D2114		\$217	F1	5.0/2.3-2.5	18	10.30	
1/3	1800	115/208-230	56C	AUTO	K235	056C17D2115	✓	\$252	F1	6.4/3.0-3.2	18	10.30	
	1800	100-120/200/240	56C	MANUAL	E250	5KCR46JN0083Y	✓	\$303	F1	4.0-3.8/2.0-1.9	24	10.77	d,ES,1,68
	1800	100-120/200/240	56C	AUTO	E252	5KCR46JN0083X	✓	\$252	F1	4.0-3.8/2.0-1.9	23	10.77	ES,1,68
1/2	1800	100-120/200-240	56C	AUTO	E261	5KCR46MN0090X	✓	\$293	F1	5.8-5.6/2.9-2.8	27	10.77	ES,1,68
	1800	100-120/200-240	56C	MANUAL	E259	5KCR46MN0090Y		\$351	F1	5.8-5.6/2.9-2.8	27	10.77	ES,1,68
3/4	1800	100-120/200-240	56C	AUTO	E270	5KCR49PN0095X	✓	\$356	F1	9.0-8.8/4.5-4.4	31	11.37	ES,1,68
	1800	100-120/200-240	56C	MANUAL	E268	5KCR49PN0095Y	✓	\$405	F1	9.0-8.8/4.5-4.4	30	11.37	ES,1,68
1	1800	100-120/200-240	56C	MANUAL	EG277	5KCR48UN0102Y		\$576	F1	11.8-11.4/5.9-5.7	40	12.65	ES,1,68
2	3600	115/208-230	56C	MANUAL	C1269	5KC49SN2537Y	✓	\$600	F1	15.6/8.8-7.8	36	11.34	
3	3600	208-230	56C	MANUAL	C1270	5KC49ZN2539Y	✓	\$733	F1	13.0-12.0	41	12.84	

General Purpose, Single Phase

Totally Enclosed



Features:

- Ball bearings
- Heavy gauge steel constructions
- Economical split phase or capacitor start designs, as noted
- Service Factor, as noted
- UL Recognized and CSA Certified

Rigid Base

HP	RPM	VOLTS	FRAME	OVER LOAD	CAT. NO.	MODEL NO.	STOCK	LIST PRICE	MULT. SYMB.	F.L. AMPS	WT.	"C" DIM.	FOOT NOTES	
1/6	1800	115	48	NONE	H116	5KH32EN66	✓	\$227	F1	4.0	15	9.92	3,17	
	900	115/230	56	NONE	C248	5KC49PN3036	✓	\$591	F1	5.6/2.8	28	12.43	2,17	
1/4	1800	115	48	AUTO	HG121	5KH32FN3123X	✓	\$249	F1	5.1	15	9.92	3,17	
	1800	115	48	NONE	HG120	5KH32FN3123	✓	\$238	F1	5.1	15	9.92	3,17	
	1800	115/230	48	AUTO	C243	5KC32GN9X	✓	\$294	F1	5.4/2.7	17	10.00	2,17	
	1800	115/230	48	NONE	C242	5KC32GN9	✓	\$281	F1	5.4/2.7	17	10.00	2,17	
	1800	230	48	AUTO	H243	5KH32GN68X	✓	\$272	F1	2.7	17	9.92	3,17	
	1500	110/220	48	NONE	C462	5KC33KN19	✓	\$325	F1	5.4/2.7	18	10.17	2,17,50	
	1800	115/208-230	56	MANUAL	G314	056C17F2052	✓	\$235	F1	4.2/2.1-2.1	20	10.22	2,18	
	1800	115/230	56	AUTO	CG251	5KC32GN19X	✓	\$306	F1	5.4/2.7	17	10.38	2,17	
	1800	115/230	56	NONE	G1312	5KC32GN19	✓	\$219	F1	5.4/2.7	16	10.38	2,17	
	1200	115/230	56	NONE	G1316	5KC49MN6061	✓	\$332	F1	6.2/3.1	27	11.43	2,17	
	1/3	3600	115	48	AUTO	HG124	5KH33FN85X	✓	\$260	F1	6.4	16	10.17	3,17
3600		115	48	NONE	HG123	5KH33FN85	✓	\$252	F1	6.4	16	10.17	3,17	
1800		115/230	56	AUTO	G1331	5KC35MN43X	✓	\$255	F1	6.0/3.0	20	10.93	2,18	
1800		115/208-230	56	MANUAL	G332	056C17F2049	✓	\$270	F1	6.0/3.0-3.0	20	10.47	2,18	
1800		100-120/200-400	56	NONE	E258	5KCR46JN0089	✓	\$392	F1	4.0-3.8/2.0-1.9	25	11.83	ES,1,20,68	
1800		115/230	56	NONE	G1330	5KC35MN43	✓	\$245	F1	6.0/3.0	17	10.93	2,18	
1200		115/230	56	NONE	C1333	5KC49PN6062	✓	\$374	F1	8.6/4.3	31	12.43	2,18	
1/2		3600	115/208-230	56	MANUAL	G393	056C34F5307	✓	\$228	F1	8.4/4.0-4.2	22	11.82	2,14,18
	3600	115/208-230	56	NONE	K339	056C34F5327	✓	\$213	F1	8.4/4.0-4.2	23	11.82	2,14,18	
	1800	100-120/200-240	56	NONE	E267	5KCR46MN0094	✓	\$446	F1	5.8-5.6/2.9-2.8	27	11.83	ES,1,19,68	
	1800	115/230	56	AUTO	C262	5KC42GN0014X	✓	\$293	F1	8.6/4.3	21	11.00	2,18	
	1800	115/208-230	56	MANUAL	G339	056C17F2051	✓	\$311	F1	8.0/4.0-4.0	23	11.22	2,18	
	1800	115/208-230	56	NONE	C261	5KC42GN0014	✓	\$276	F1	8.6/4.1-4.3	21	11.00	2,18	
	1800	115/230	48	NONE	CG260	5KC37RN35	✓	\$361	F1	8.8/4.4	23	11.38	2,17	
	1200	115/230	56	NONE	C264	5KC49UN6065	✓	\$474	F1	9.4/4.7	40	12.96	2,18	
	3/4	3600	115/208-230	56	MANUAL	G379	056C34F5309	✓	\$277	F1	10.6/5.3-5.3	26	12.32	2,14,18
		3600	115/208-230	56	NONE	G352	056C34F5308	✓	\$260	F1	10.6/5.3-5.3	26	12.32	2,14,18
1800		100-120/200-240	56	NONE	EG276	5KCR49PN0101	✓	\$497	F1	9.0-8.8/4.5-4.4	31	12.43	ES,1,7,19,68	
1800		115/230	56	AUTO	C269	5KC46PN0015X	✓	\$359	F1	11.0/5.5	31	11.83	2,17	
1800		115/208-230	56	MANUAL	G356	056C17F5308	✓	\$382	F1	11.0/5.4-5.5	29	12.32	2,14,18	
1800		115/208-230	56	NONE	C268	5KC46PN0015	✓	\$340	F1	11.0/5.4-5.5	31	11.83	2,18	
1200		115/230	56	NONE	C271	5KCR48WN6066	✓	\$566	F1	10.6/5.3	44	13.82	ES,1,17	
1200		115/208-230	143T	NONE	I707	143TBFR5376	✓	\$591	S1	11.4/5.8-5.7	42	13.87	1,14,18	

SINGLE PHASE

Continued on next page.

General Purpose, Single Phase

Totally Enclosed

Rigid Base

HP	RPM	VOLTS	FRAME	OVER LOAD	CAT. NO.	MODEL NO.	STOCK	LIST PRICE	MULT. SYMB.	F.L. AMPS	WT.	"C" DIM.	FOOT NOTES
1	3600	115/208-230	56	NONE	G359	056C34F5310	✓	\$298	F1	12.4/6.7-6.2	30	12.32	2,14,18
	3600	115/230	56	AUTO	C273	5KC49NN2130X	✓	\$313	F1	13.0/6.5	29	12.43	2,17
	3600	115/208-230	56	MANUAL	G390	056C34F5311	✓	\$313	F1	12.4/6.7-6.2	31	12.32	2,14,18
	3600	115/230	56	MANUAL	C274	5KC49NN2130Y	✓	\$313	F1	13.0/6.5	21	12.43	2,17
	1800	115/230	56	NONE	C275	5KC49TN0034	✓	\$383	F1	13.2/6.6	38	12.96	2,17
	1800	100-120/200-240	56	NONE	E285	5KCR49UN0108	✓	\$571	F1	11.8-11.4/5.9-5.7	40	12.96	ES,1,68
	1800	115/208-230	56	MANUAL	G373	056C17F5311	✓	\$400	F1	13.4/6.8-6.7	30	12.82	2,14,18
	1800	115/230	56	AUTO	C276	5KC49TN0034X	✓	\$392	F1	13.2/6.6	36	12.96	2,17
	1800	115/230	143T	NONE	C295	5KC49TN0033	✓	\$400	S1	13.2/6.6	38	13.33	2,17
1 1/2	3600	115/208-230	56H	MANUAL	G391	056B34F5321	✓	\$410	F1	14.2/7.7-7.1	33	12.82	1,5,14,18
	3600	115/208-230	56H	NONE	G374	056B34F5320	✓	\$382	F1	14.2/7.7-7.1	32	12.82	1,5,14
	3600	115/208-230	143T	NONE	I220	143TBF5301	✓	\$424	S1	14.2/7.7-7.1	33	12.87	1,14,18
	1800	115/208-230	56H	MANUAL	G378	056B17F5302	✓	\$459	F1	15.2/8.2-7.6	40	13.82	1,5,14,18
	1800	115/208-230	56H	NONE	G1376	5KCR48WN0273	✓	\$436	F1	14.5/7.1-7.3	44	13.82	ES,1,5,18
	1800	115/208-230	56H	AUTO	G1377	5KCR48WN0273X	✓	\$451	F1	14.5/7.1-7.3	44	13.82	ES,1,5,18
	1800	115/208-230	145T	MANUAL	I201	145TBF5327	✓	\$507	S1	15.2/8.2-7.6	41	13.87	1,14,18
	1800	115/208-230	145T	NONE	C297	5KCR48WN0292	✓	\$450	S1	14.5/7.1-7.3	44	14.07	1,18
	1800	115/208-230	145T	NONE	G1392	5KCR49TN2139U	✓	\$464	F1	17.8/8.9	38	14.27	ES,1,18
2	3600	115/208-230	56H	NONE	K350	056B34F5322		\$447	F1	18.0/10.0-9.0	38	13.32	1,5,14,18
	3600	115/208-230	145T	NONE	I221	145TBF5303	✓	\$464	S1	18.0/10.0-9.0	39	13.37	1,14,18
	1800	115/230	145T	NONE	I700	145TBF5334	✓	\$567	S1	18.8/9.4	50	14.87	1,14,18
	1800	115/208-230	182T	NONE	I212	182TBF5326	✓	\$613	S1	20.0/10.8-10.0	52	15.65	F,1,18
	1800	115/208-230	182T	NONE	I206	182TBF5301	✓	\$714	S1	24.6/13.9-12.3	57	15.81	1,17
3	3600	208-230	145T	NONE	I204	145TBF5301		\$632	S1	13.1-11.8	50	14.87	1,14,18
	3600	208-230	145T	MANUAL	I205	145TBF5302		\$680	S1	13.1-11.8	50	14.87	1,14,18
	1800	115/208-230	184T	NONE	I213A	184TBFW17044	✓	\$731	S1	28.4/14.8-14.2	72	14.96	1,13,14,17
	1800	115/208-230	184T	NONE	I223A	184TBFW7701	✓	\$912	S1	22.0-19.8	98	16.49	1,13,14,17
5	1800	208-230	184T	NONE	I214A	184TBFW7726	✓	\$900	S1	21.5-19.5	103	17.46	1,13,14,18
	1800	208-230	213T	NONE	I216	213TBFW7026	✓	\$971	S1	24.5-22.0	106	18.73	1,14,17
	7 1/2	3600	208-230	213T	NONE	I224	213TBFW7001	✓	\$1,224	S1	36.0-32.0	112	20.23
7 1/2	1800	208-230	215T	NONE	I215	215TBFW7026	✓	\$1,195	S1	35.0-30.0	133	21.48	1,14,17
	10	3600	208-230	215T	NONE	I225	215TBFW7001	✓	\$1,491	S1	44.0-41.5	141	20.23
10	1800	230	215T	NONE	I217	215TBFW7027	✓	\$1,533	S1	41.5	144	21.48	1,14,17

SINGLE PHASE

General Purpose, Single Phase

Totally Enclosed

Features:

- Ball bearings mechanically locked on shaft end (excludes 5K models)
- Heavy gauge steel constructions
- Suitable for horizontal or vertical mounting
- Economical split phase or capacitor start designs, as noted
- Will accept brake kits, see Accessory section (except as noted)
- Service Factor, as noted
- UL Recognized and CSA Certified



C-Face Footless

HP	RPM	VOLTS	FRAME	OVER LOAD	CAT. NO.	MODEL NO.	STOCK	LIST PRICE	MULT. SYMB.	F.L. AMPS	WEIGHT	"C" DIM.	FOOT NOTES
1/6	1800	115	56C	NONE	H244	5KH32EN124	✓	\$277	F1	4.0	10	10.30	3,17,24
1/4	1800	115/230	56C	NONE	G1511	5KC32GN25	✓	\$231	F1	5.4/2.7	16	10.30	2,17,24
	1200	115/230	56C	NONE	C1423	5KC49MN6063		\$356	F2	6.2/3.1	27	11.40	2,17,24
1/3	3600	115/230	56C	NONE	C1419	5KC33FN31	✓	\$205	F1	5.6/2.8	14	10.19	18,24
	1800	100-120/200-240	56C	NONE	E256	5KCR46JN0088	✓	\$417	F1	4.0-3.8/2.0-1.9	25	11.84	ES,1,20,24,68
	1800	115/230	56C	NONE	G1513	5KC35MN73	✓	\$266	F1	6.0/3.0	19	10.93	2,18,24
1/2	3600	115/208-230	56C	NONE	G514	056C34F5322		\$223	F1	8.4/4.0-4.2	23	11.82	2,18
	3600	115/230	56C	AUTO	C349	5KC36LN166X	✓	\$319	F1	7.4/3.7	19	11.36	2,18,24
	1800	100-120/200-240	56C	NONE	E265	5KCR46MN0093	✓	\$468	F1	5.8-5.6/2.9-2.8	27	11.84	ES,1,19,24,68
	1800	115/230	56C	AUTO	C446	5KC42GN0018X	✓	\$375	F1	8.6/4.3	21	11.01	2,18,24
	1800	115/230	56C	NONE	G1515	5KC42GN0018	✓	\$307	F1	8.6/4.3	21	11.01	2,18,24
	1200	115/230	56C	NONE	C1404	5KC49UN6067	✓	\$644	F1	9.4/4.7	40	12.93	2,17,24
3/4	3600	115/208-230	56C	NONE	G516	056C34F5323	✓	\$273	F1	10.6/5.3-5.3	26	12.32	2,18
	1800	100-120/200-240	56C	NONE	E274	5KCR49PN0100	✓	\$517	F1	9.0-8.8/4.5-4.4	31	12.44	ES,1,19,24,68
	1800	115/230	56C	NONE	G1517	5KC46PN0032	✓	\$369	F1	11.0/5.5	31	11.84	2,17,24
1	3600	115/208-230	56C	NONE	G518	056C34F5324	✓	\$309	F1	12.4/6.7-6.2	29	12.32	2,18
	3600	115/230	56C	AUTO	C351	5KC49NN2133X	✓	\$407	F1	13.0/6.5	29	12.44	2,18,24
	1800	100-120/200-240	56C	NONE	EG283	5KCR49UN0107	✓	\$593	F1	11.8-11.4/5.9-5.7	40	12.97	ES,1,18,24,68
	1800	115/230	56C	NONE	G1519	5KC49TN0035	✓	\$393	F1	13.2/6.6	36	12.97	2,17,24
1 1/2	3600	115/230	56C	NONE	C1424	5KC49SN2158	✓	\$392	F1	16.4/8.2	35	12.93	2,24,111
	3600	115/230	56C	AUTO	C855	5KC49SN2156X	✓	\$498	F1	16.4/8.2	35	12.93	2,17,24
	1800	115/208-230	56C	NONE	G1531	5KCR48WN0294	✓	\$454	F1	14.5/7.1-7.3	44	13.69	ES,1,18,24
2	3600	115/208-230	56C	NONE	G533	056B34F5319	✓	\$476	F1	18.0/10.0-9.0	38	13.32	1,18
	3600	115/230	56C	AUTO	C466	5KCR49TN2155T	✓	\$610	F1	17.8/8.9	38	14.28	1,17,24

SINGLE PHASE

General Purpose, Single Phase

Totally Enclosed

Features:

- Ball bearings mechanically locked on shaft end (excludes 5K models)
- Heavy gauge steel constructions
- Suitable for horizontal or vertical mounting
- Economical split phase or capacitor start designs, as noted
- Will accept brake kits, see Accessory section (except as noted)
- Service Factor, as noted
- UL Recognized and CSA Certified



C-Face Footed (Rigid Base)

HP	RPM	VOLTS	FRAME	OVER LOAD	CAT. NO.	MODEL NO.	STOCK	LIST PRICE	MULT. SYMB.	F.L. AMPS	WEIGHT	"C" DIM.	FOOT NOTES
1/3	1800	100-120/200-240	56C	AUTO	E257	5KCR46JN0087X	✓	\$434	F1	4.0-3.8/2.0-1.9	23	11.84	ES,1,20,24,68
	1800	100-120/200-240	56C	MANUAL	E255	5KCR46JN0087Y	✓	\$437	F1	4.0-3.8/2.0-1.9	26	11.84	ES,1,20,24,68
	1800	115/208-230	56C	MANUAL	F131	056C17F5358	✓	\$347	F1	6.6/3.1-3.3	23	11.82	2,18,68
	1800	115/230	56C	NONE	C1405	5KC35MN145	✓	\$270	F1	6.0/3.0	17	10.93	2,24,18,68
1/2	3600	115/208-230	56C	NONE	C1420	5KC36LN144	✓	\$228	F1	7.4/3.7	17	11.36	2,24,19,68
	3600	115/230	56C	AUTO	C444	5KC36LN144X	✓	\$235	F2	7.4/3.7	25	11.36	24,68
	1800	100-120/200-240	56C	MANUAL	E264	5KCR46MN0055Y	✓	\$484	F1	5.8-5.6/2.9-2.8	29	11.84	ES,1,19,24,68
	1800	100-120/200-240	56C	AUTO	E266	5KCR46MN0055X	✓	\$472	F1	5.8-5.6/2.9-2.8	29	11.84	ES,1,19,24,68
	1800	115/208-230	56C	MANUAL	F132	056C17F5912	✓	\$388	F1	8.8/4.2-4.4	25	11.82	2,18,68
3/4	1800	115/230	56C	NONE	C375	5KC42GN0066	✓	\$311	F1	8.6/4.3	23	11.01	2,18,24,68
	1800	100-120/200-240	56C	MANUAL	EG273	5KCR49PN0099Y	✓	\$540	F1	9.0-8.8/4.5-4.4	31	12.44	ES,1,19,24,68
	1800	100-120/200-240	56C	AUTO	E275	5KCR49PN0099X	✓	\$530	F1	9.0-8.8/4.5-4.4	31	12.44	ES,1,19,24,68
	1800	115/208-230	56C	MANUAL	F133	056C17F5913	✓	\$451	F1	11/5.4-5.5	29	12.32	2,18,68
	1800	115/230	56C	NONE	C1425	5KC49PN0283	✓	\$374	F1	11.0/5.5	31	12.40	2,17,24,68
1	1200	115/230	56C	NONE	C1412	5KCR49WN6078		\$605	F2	12.6/6.3	44	13.81	ES,1,24,68
	3600	115/230	56C	AUTO	C445	5KC49NN2132X	✓	\$321	F2	13.0/6.5	29	12.44	24,68
	1800	100-120/200-240	56C	MANUAL	EG282	5KCR49UN0106Y	✓	\$615	F1	11.8-11.4/5.9-5.7	40	12.97	ES,1,18,24,68
	1800	100-120/200-240	56C	AUTO	EG284	5KCR49UN0106X	✓	\$610	F1	11.8-11.4/5.9-5.7	40	12.97	ES,1,18,24,68
	1800	115/208-230	56C	NONE	C376	5KC49TN0067	✓	\$400	F1	13.2/6.7-6.6	38	12.97	2,17,24,68
1 1/2	1800	115/208-230	56C	MANUAL	F134	056C17F5914	✓	\$485	F1	13.4/6.8-6.7	31	12.82	2,18,68
	3600	115/208-230	56HCZ	NONE	K631	056B34F5324		\$397	F1	14.2/7.7-7.1	34	12.82	1,18,68
	1800	115/208-230	56C	MANUAL	F135	056B17F5584	✓	\$583	F1	15.2/8.2-7.6	41	13.82	1,5,18,68
	1800	115/208-230	145TC	NONE	C281	145TBFR5337		\$567	S1	15.2/8.2-7.6	43	13.87	1,18,68
2	3600	115/208-230	145TC	NONE	C282	145TBFR5305		\$632	S1	16.6/9.1-8.3	42	13.37	1,18,68
	1800	115/230	56HC	MANUAL	K319	056B17F5319	✓	\$598	F1	18.8/9.4	50	14.82	1,5,18,68
3	3600	208-230	145TC	NONE	C284	145TBFR5306		\$678	S1	13.1-11.8	52	14.87	1,18,68
	1800	230	184TC	MANUAL	I314A	184TBFW7041	✓	\$896	S1	12.8	86	14.96	1,13,18,68
5	1800	230	184TC	MANUAL	I315A	184TBFW7034	✓	\$1,069	S1	21	101	17.47	1,13,17,68

SINGLE PHASE

General Purpose, Single Phase

Totally Enclosed, Four in One

Features:

- Double sealed ball bearings, mechanically locked on shaft end
- Heavy gauge steel constructions
- Bolt-on, removable rigid base
- Suitable for horizontal or vertical mounting
- Capacitor start design for high starting torque
- Capacitor start/capacitor run design for higher efficiency, as noted
- 1.15 Service Factor (except as noted)
- Will accept brake kits, see Accessory section
- Will accept drip cover kits, see Accessories section
- UL Recognized and CSA Certified



C-Face Footed (Removable Base)

HP	RPM	VOLTS	FOUR-N ONE	FRAME	OVER LOAD	CAT. NO.	MODEL NO.	STOCK	LIST PRICE	MULT. SYMB.	F.L. AMPS	WEIGHT	"C" DIM.	FOOT NOTES
1/4	1200	115/208-230	YES	56C	NONE	G577	056C11F5302	✓	\$356	F2	6.8/3.1-3.4	24	11.82	
1/3	1800	115/208-230	YES	56C	NONE	G570	056C17F5320	✓	\$277	F2	6.6/3.1-3.3	23	11.82	68
	1200	115/208-230	YES	56C	NONE	G576	056C11F5303	✓	\$397	F2	7.8/3.6-3.9	27	12.32	
1/2	3600	115/208-230	YES	56C	NONE	D311	056C34F5301	✓	\$235	F2	8.4/4.0-4.2	22	11.82	
	1800	115/208-230	YES	56C	NONE	G571	056C17F5321	✓	\$317	F2	8.8/4.2-4.4	24	11.82	68
	1200	115/208-230	YES	56C	NONE	G578	056B11F5303	✓	\$484	F2	9.6/4.7-4.8	35	13.32	1,68
3/4	3600	115/208-230	YES	56C	NONE	D312	056C34F5302	✓	\$284	F2	10.6/5.3-5.3	27	12.32	
	1800	115/208-230	YES	56C	NONE	G572	056C17F5322	✓	\$382	F2	11.0/5.4-5.5	30	12.32	68
	1200	115/208-230	YES	56C	NONE	G579	056B11F5302	✓	\$605	F2	11.4/5.8-5.7	39	13.82	1
1	3600	115/208-230	YES	56C	NONE	D313	056C34F5303	✓	\$321	F2	11.2/5.7-5.6	30	12.32	
	1800	115/208-230	YES	56HC	NONE	G573	056C17F5323	✓	\$406	F2	13.4/6.8-6.7	31	12.82	5,68
1 1/2	3600	115/208-230	YES	56C	NONE	D314	056B34F5326	✓	\$404	F2	14.2/7.7-7.1	32	12.82	1
	1800	115/208-230	YES	56HC	NONE	G574	056B17F5305	✓	\$466	F2	15.2/8.2-7.6	40	13.82	1,5,68
2	3600	115/208-230	YES	56HC	NONE	D315	056B34F5327	✓	\$486	F2	16.6/9.1-8.3	37	13.82	1,5
	1800	115/208-230	YES	56HC	NONE	G575	056B17F5306	✓	\$584	F2	20.0/10.8-10.0	51	14.82	1,5,17
3	3600	208-230	YES	56HC	NONE	D316	056B34F5328	✓	\$650	F2	13.1-11.8	50	14.82	1,5

C-Face Footed (Removable Base)

50 Hertz

HP	RPM	VOLTS	FOUR-N ONE	FRAME	OVER LOAD	CAT. NO.	MODEL NO.	STOCK	LIST PRICE	MULT. SYMB.	F.L. AMPS	WEIGHT	"C" DIM.	FOOT NOTES
1/2	3000	220-240	YES	56C	NONE	D1312			\$327	F2	5.6-5.4	27	12.32	
	1500	220-240	YES	56C	NONE	G1572			\$439	F2	5.7-5.5	30	12.32	
3/4	3000	220-240	YES	56C	NONE	D1313			\$369	F2	5.8-5.6	30	12.32	
	1500	220-240	YES	56HC	NONE	G1573			\$467	F2	6.9-6.7	31	12.82	5
1 1/2	3000	220-240	YES	56C	NONE	D1314			\$465	F2	7.3-7.1	32	12.82	1
	1500	220-240	YES	56HC	NONE	G1574			\$536	F2	7.8-7.6	40	13.82	1,5
1	3000	220-240	YES	56HC	NONE	D1315			\$559	F2	8.5-8.3	37	13.82	1,5
	1500	220-240	YES	56HC	NONE	G1575			\$672	F2	10.4-10.0	51	14.82	1,5,17
2	3000	220-240	YES	56HC	NONE	D1316			\$748	F2	12.1-11.8	50	14.82	1,5
	1500	220-240	YES	56HC	NONE	G1576			\$897	F2	13.1-13.5	68	14.82	1,5

Hazardous Duty™ Division 1 Explosion Proof Class I and II, Groups C (as noted), D, F & G Steel Frame, Single Phase

Features:

- 1.0 Service Factor
- Automatic reset thermal protector
- Meets temperature code T3B
- Economical split phase or capacitor start designs, as noted
- Explosion proof conduit box included, shipped loose
- UL Listed File No. E12044
- CSA Certified File No. LR47504



Resilient Base

HP	RPM	VOLTS	FRAME	GROUP C	CAT. NO.	MODEL NO.	STOCK	LIST PRICE	MULT. SYMB.	F.L. AMPS	WEIGHT	"C" DIM.	FOOT NOTES
1/4	1800	115	56	N	K032	56C17E5302		\$374	F1	4.8	26	11.88	2,N
	1200	115	56	N	K033	56C11G5303	✓	\$514	F1	5.4	31	14.46	2,37
1/3	1800	115	56	N	K037	56C17G5308		\$489	F1	6.6	29	13.96	2,37



Rigid Base

HP	RPM	VOLTS	FRAME	GROUP C	CAT. NO.	MODEL NO.	STOCK	LIST PRICE	MULT. SYMB.	F.L. AMPS	WEIGHT	"C" DIM.	FOOT NOTES
1/12	1800	115	48	N	H454	5KH32ENB168X	✓	\$451	F1	1.9	18	9.68	3,N
1/8	1200	115	48	N	HG455	5KH36NNB166X	✓	\$511	F1	3.0	23	10.74	3,N
1/6	1800	115	48	N	HG456	5KH35LNB164X	✓	\$468	F1	3.3	22	10.31	3,N
	1200	115	56	Y	H891	5KC49LN6386X	✓	\$598	F1	3.8	26	12.47	3,N
1/4	1800	115	48	N	HG458	5KH36PNB171X	✓	\$484	F1	4.4	24	10.74	3,N
	1800	115/208-230	56	Y	G639	56C17E5314	✓	\$446	F1	4.8/2.3-2.4	26	11.97	2,N
	1800	115/230	48	N	C646	5KC36PNB169X	✓	\$548	F1	4.2/2.1	25	10.74	2,N
	1200	115	56	Y	C1801	5KC49MN6384X	✓	\$713	F1	5.6	34	13.94	2
	1200	115/208-230	56	Y	G650	56C11G5306	✓	\$597	F1	6.8/3.1-3.4	28	13.94	2
1/3	1800	115/208-230	56	Y	G651	56C17G5315	✓	\$509	F1	6.6/3.1-3.3	27	13.44	2
	1500	110/220-230	56	Y	C1803	5KC49HN0719X	✓	\$603	F1	6.8/3.1-3.4	31	13.44	2
	1200	115/208-230	56	Y	G652	56C11G5307	✓	\$641	F1	7.8/3.6-3.9	31	13.94	2
1/2	3600	115/208-230	56	Y	G653	56C34G5308	✓	\$458	F1	8.4/4.0-4.2	26	13.44	2
	1800	115/208-230	56	Y	G654	56C17G5316	✓	\$556	F1	8.8/4.2-4.4	27	13.94	2
	1500	110/220-230	56	Y	C1807	5KC49QN0716X	✓	\$618	F1	8.4/4.2-4.4	33	14.44	2, 50
	1200	115/208-230	56	Y	C1809	5KC49SN6375X		\$739	F1	9.4/4.7-5.0	39	14.94	2
	1200	115/208-230	56	Y	G655	56B11G5301	✓	\$739	F1	9.6/4.7-4.8	39	14.94	1
3/4	3600	115/208-230	56	Y	G656	56C34G5309		\$516	F1	10.6/5.3-5.3	31	13.94	2
	1800	115/208-230	56	Y	G657	56C17G5317	✓	\$624	F1	11.0/5.4-5.5	33	14.44	2
1	3600	115/208-230	56	Y	G658	56C34G5310		\$557	F1	12.4/6.7-6.2	40	14.44	2
	1800	115/208-230	56	Y	G659	56C17G5318	✓	\$652	F1	13.4/6.8-6.7	34	14.08	2

SINGLE PHASE

Hazardous Duty™ Division 1 Explosion Proof Class I and II, Groups C, D, F & G

Steel Frame, Single Phase

Features:

- 1.0 Service Factor
- Automatic reset thermal protector
- Meets temperature code T3B
- 56CZ frame motors have 2-1/4 x 5/8 shaft dimensions
- Capacitor start design for high starting torque
- Explosion proof conduit box included, shipped loose
- UL Listed File No. E12044, MC228275
- CSA Certified File No. LR47504, MC236833



C-Face Footless

HP	RPM	VOLTS	FRAME	CAT. NO.	MODEL NO.	STOCK	LIST PRICE	MULT. SYMB.	F.L. AMPS	WEIGHT	"C" DIM.	FOOT NOTES
1/4	1800	115/208-230	56C	G852	56C17E5319	✓	\$463	F1	4.8/2.3-2.4	22	11.97	N
	1200	115	56CZ	C1818	5KC49MN6379X	✓	\$667	F1	5.6	34	14.30	37
1/3	1800	115/208-230	56C	G853	56C17G5320	✓	\$522	F1	6.6/3.1-3.3	27	13.44	
1/2	3600	115/208-230	56C	G854	56C34G5311	✓	\$470	F1	8.4/4.0-4.2	26	13.44	
	3600	115/208-230	56J	C1814	5KC49HN2509X	✓	\$690	F1	8.4/4.0-4.2	27	13.95	15
	1800	115/208-230	56C	G855	56C17G5321	✓	\$568	F1	8.8/4.2-4.4	28	13.94	
	1200	115	56CZ	C1817	5KC49SN6380X	✓	\$850	F1	8.0	47	15.30	
3/4	1800	115/208-230	56C	G857	56C17G5322	✓	\$636	F1	11.0/5.4-5.5	33	14.44	
1	3600	115/208-230	56C	G858	56C34G5316		\$570	F1	12.4/6.2-6.7	34	14.44	
	1800	115/208-230	56C	G870	56C17G5323	✓	\$664	F1	13.4/6.8-6.7	34	14.44	



C-Face Footed (Rigid Base)

HP	RPM	VOLTS	FRAME	CAT. NO.	MODEL NO.	STOCK	LIST PRICE	MULT. SYMB.	F.L. AMPS	WEIGHT	"C" DIM.	FOOT NOTES
1/3	1800	115/208-230	56C	G871	56C17G5324	✓	\$501	F1	6.6/3.1-3.3	37	13.44	
1/2	1800	115/208-230	56C	G872	56C17G5328	✓	\$573	F1	8.8/4.2-4.4	29	13.94	
3/4	3600	115/208-230	56C	G873	56C34G5314	✓	\$533	F1	10.6/5.3-5.3	30	13.94	
	1800	115/208-230	56C	G874	56C17G5326	✓	\$641	F1	11.0/5.4-5.5	34	14.44	
1	3600	115/208-230	56C	G875	56C34G5315		\$576	F1	12.4/6.0-6.2	34	14.44	
	1800	115/208-230	56C	G876	56C17G5327	✓	\$680	F1	13.4/6.8-6.7	35	14.44	

SINGLE PHASE

General Purpose, Three Phase

Dripproof, Rigid Base

Features:

- EISA compliant efficiencies, as noted
- Ball bearings (except where noted)
- NEMA Service Factors
- Will accept C-Face Kits, see Accessories Section (except as noted)
- UL Recognized and CSA Certified



As Noted



Suitable for use on VFD per guidelines on page 17.

HP	RPM	VOLTS	FRAME	OVER LOAD	CAT. NO.	MODEL NO.	STOCK	LIST PRICE	MULT. SYMB.	NOM. EFF.	F.L. AMPS	WEIGHT	"C" DIM.	FOOT NOTES	C-FACE KITS	
1/4	1800	208-230/460	48	NONE	G044	048T17D2000	✓	\$195	F1	62.0	1.2-1.3/.65	13	9.34	25,68	N/A	
1/3	3600	208-230/460	48	NONE	K113	5K35FN2	✓	\$187	F1	61.0	1.5-1.8/0.9	14	9.25		N/A	
	1800	208-230/460	48	NONE	K527	5K35JN198	✓	\$227	F1	66.5	1.5-1.6/0.8	15	9.25		N/A	
	1800	200-208	56	NONE	G046	056T17D2128		\$227	F1	67.0	1.8-1.9	15	9.97	25	N/A	
	1800	208-230/460	56	NONE	G047	056T17D2095	✓	\$227	F1	67.0	1.5-1.6/0.8	15	9.97	25,68	N/A	
	1200	208-230/460	56	NONE	G061	056T11D5301		\$309	F1	62.0	1.9-2.2/1.1	19	9.94	68	A435	
1/2	3600	208-230/460	56	NONE	K027	056T34D5300		\$207	F1	66.0	2.1-2.2/1.1	20	10.44	68	A435	
	3600	208-230/460	48	NONE	K115	5K36JN2	✓	\$207	F1	69.8	2.0-2.0/1.0	16	9.68		N/A	
	1800	200-208	56	NONE	G062	056T17D2114	✓	\$255	F1	70.0	2.5-2.65	17	10.47	25	N/A	
	1800	208-230/460	56	NONE	G063	056T17D2094	✓	\$262	F1	70.0	2.1-2.2/1.1	17	10.47	25,68,CF	N/A	
	1800	208-230/460	56	NONE	K116	5K42HN4106	✓	\$254	F1	74.7	2.3-2.2/1.1	19	10.05	19	A534	
	1800	208-230/460	56	NONE	E12D4	5KS49HN4077	✓	\$369	F1	76.9	1.8-1.8/0.9	20	10.38	ES	A534	
	1800	208-230/460	56	AUTO	G905	056T17D5336	✓	\$316	F1	68.0	2.3-2.4/1.2	21	10.44	VC,68	A435	
	1800	575	56	NONE	G065	056T17D2112	✓	\$255	F1	70.0	0.9		17	10.47	25	N/A
	1500	220/380	56	NONE	K318	5K42JN4163	✓	\$352	F1	66.7	3.0/1.7	21	10.05	50	A534	
	1200	208-230/460	56	NONE	G067	056T11D5302	✓	\$342	F1	68.0	2.4-2.7/1.35	23	10.44	68	A435	
	900	208-230/460	143T	NONE	H180	143TTDR5401		\$416	E6	64.0	2.9-3.0/1.5	32	11.49	5,13	A436	
3/4	3600	208-230/460	56	NONE	G080	056T34D5301	✓	\$231	F1	74.0	3.0-3.2/1.6	21	10.44	68	A435	
	1800	200-208	56	NONE	G082	056T17D2111	✓	\$285	F1	75.5	3.2-3.3	21	10.97	25	N/A	
	1800	208-230/460	56	NONE	G084	056T17D2093	✓	\$305	F1	75.5	2.7-2.8/1.4	20	10.97	25,68,CF	N/A	
	1800	208-230/460	56	NONE	K119	5K46KN4071	✓	\$295	F1	74.3	3.3-3.0/1.5	24	10.78	19	A534	
	1800	208-230/460	56	AUTO	G908	056T17D5339	✓	\$346	F1	75.5	2.9-3.0/1.5	22	10.44	68	A435	
	1800	200-230/460	56	NONE	E34D4	5KS46MN4078	✓	\$414	F1	79.2	2.5-2.4/1.2	24	10.78	ES,68	A534	
	1800	575	56	NONE	G086	056T17D2110	✓	\$285	F1	75.5	1.1		20	10.97	25	A435
	1200	208-230/460	56	NONE	G088	056T11D5303		\$353	F1	74.0	3.1-3.2/1.6	25	10.94	68	A435	
	1200	208-230/460	143T	NONE	H150	143TTDR5376	✓	\$321	E6	74.0	3.1-3.2/1.6	29	10.99	5,68	A436	
	900	208-230/460	145T	NONE	H181	145TTDR5401	✓	\$472	E6	72.0	4.0-4.0/2.0	42	12.99	68	A436	
	1	3600	208-230/460	56	NONE	K000	056T34D5302	✓	\$263	F1	74.0	3.7-3.7/1.85	23	10.44		A435
1800		200	143T	NONE	E901	143TTDR5348	✓	\$297	E2	82.5	3.6	40	12.49	5,13	A436	
1800		200-208	56	NONE	K003	056T17D2113	✓	\$293	F1	76.5	3.9-4.1	23	11.47	25	N/A	
1800		200-208	143T	AUTO	U416	143TTDR4061		\$423	E2	82.5	3.6-3.43	39	12.49	5,13	A436	
1800		208-230/460	56	NONE	K004	056T17D2092	✓	\$310	F1	76.5	3.4-3.4/1.7	23	11.47	25,68,CF	N/A	
1800		208-230/460	56	NONE	K122	5K46MN4072	✓	\$300	F1	79.2	3.6-3.8/1.9	27	10.78	19	A534	
1800		208-230/460	56	NONE	K2069	5KE49PN4594	✓	\$417	F1	82.5	3.2-3.1/1.55	30	11.38		A534	
1800		208-230/460	56	AUTO	G921	056T17D5342	✓	\$353	F1	77.0	3.5-3.6/1.8	24	10.94	VC,68	A436	
1800		208-230/460	56HZ	AUTO	K063	056T17D3301	✓	\$375	F1	77.0	3.5-3.6/1.8	27	10.99	Z,5,68	A436	
1800		208-230/460	56HZ	AUTO	K067	056T17D3305		\$389	F1	77.0	3.5-3.6/1.8	27	10.99	VC,Z,5,68	A436	

Catalog numbers (Cat No.) highlighted in bold blue have efficiency levels that meet EISA requirements

Continued on next page.

GENERAL PURPOSE THREE PHASE

General Purpose, Three Phase

Drip-proof, Rigid Base

HP	RPM	VOLTS	FRAME	OVER LOAD	CAT. NO.	MODEL NO.	STOCK	LIST PRICE	MULT. SYMB.	NOM. EFF.	F.L. AMPS	WEIGHT	"C" DIM.	FOOT NOTES	C-FACE KITS	
1	1800	208-230/460	143T	AUTO	U417A	143TTDR6052		\$495	E2	85.5	3.2-3.0/1.5	45	12.99	5,13,68	A436	
	1800	208-230/460	143T	AUTO	U418A	143TTDR6051	✓	\$515	E2	85.5	3.2-3.0/1.5	45	12.99	VC,5,13,68	A436	
	1800	575	56	NONE	K049	056T17D2130	✓	\$293	F1	76.5	1.4	24	11.47	25	N/A	
	1800	575	56HZ	AUTO	K081	056T17D15528		\$375	F1	77.0	1.45	27	10.99	Z,5	A436	
	1800	575	143T	AUTO	U922	143TTDR4055		\$423	E2	82.5	1.1	39	12.49	5,13	A436	
	1800	575	143T	AUTO	U922A	143TTDR16036		\$495	E2	85.5	1.2	45	12.99	5,13	A436	
	1800	575	143T	NONE	E912	143TTDR5351		\$297	E2	82.5	1.1	39	12.49	5,13	A436	
	1200	200	145T	NONE	E785	145TTDR4078		\$389	E2	80.0	4.1	47	13.49	5,13	A436	
	1200	208-230/460	56H	NONE	K007	056T11D5304		\$382	F1	75.5	4.1-4.2/2.1	29	11.44	5,68	A435	
	1200	575	145T	NONE	E934	145TTDR4080		\$389	E2	80.0	1.4	47	13.49	5,13	A436	
	900	230/460	182T	NONE	H182A	182TTDW7101		\$511	E6	75.8	4.0/2.0	69	12.19	13	A666	
	1 1/2	3600	200	143T	NONE	E917	14TTDR4005		\$330	E2	82.5	5.5	31	10.90	5,13	A436
		3600	208-230/460	56	NONE	K009	056T34D5303	✓	\$324	F1	80.0	4.9-5.0/2.5	24	10.44	68	A435
		3600	208-230/460	143T	NONE	E783A	143TTDR6313	✓	\$452	E2	86.5	4-3.8/1.9	101	12.49	5,13,68	A436
3600		575	143T	NONE	E798	143TTDR4006		\$330	E2	82.5	1.9	28	10.99	5,13	A436	
1800		200	145T	NONE	E902	145TTDR5632	✓	\$324	E2	84.0	5.0	39	12.49	5,13	A436	
1800		200-208	145T	AUTO	U419	145TTDR4128		\$450	E2	84.0	5.0-4.9	39	12.49	5,13	A436	
1800		208-230/460	56H	NONE	K022	056T17D5309	✓	\$325	F1	80.0	4.8-4.8/2.4	28	10.94	5,68	A436	
1800		208-230/460	56H	AUTO	G923	056T17D5344	✓	\$386	F1	80.0	4.8-4.8/2.4	27	10.94	VC,5,68	A436	
1800		208-230/460	56HZ	AUTO	K064	056T17D3302	✓	\$398	F1	80.0	4.8-4.8/2.4	30	10.99	Z,5,68	A436	
1800		208-230/460	56HZ	AUTO	K068	056T17D3306	✓	\$408	F1	80.0	4.8-4.8/2.4	33	10.99	VC,Z,5,68	A436	
1800		208-230/460	145T	AUTO	U420A	145TTDR6126	✓	\$526	E2	86.5	4.4-4.4/2.2	48	12.49	5,13,68	A436	
1800		208-230/460	145T	AUTO	U421A	145TTDR6127		\$546	E2	86.5	4.4-4.4/2.2	48	12.49	VC,5,13,68	A436	
1800		575	56H	NONE	K061	056T17D5369	✓	\$325	F1	80.0	1.9	27	10.94	5	A436	
1800		575	145T	AUTO	U923	145TTDR4130		\$450	E2	84.0	1.8	39	12.49	5,13	A436	
2	1800	575	145T	AUTO	U923A	145TTDR16054		\$553	E2	86.5	1.8	47	12.99	5,13	A436	
	1500	220/380	145T	NONE	K408	5K49SN8050	✓	\$456	E2	81.7	4.5/2.6	35	13.59	50	A536	
	1200	200	182T	NONE	E1799	182TTDW4083	✓	\$428	E2	84.0	7.2	75	12.69	13	A666	
	900	230/460	184T	NONE	H183A	184TTDW7101		\$620	E6	77.0	5.6/2.8	62	13.19	13	A666	
	3600	200	145T	NONE	U905	145TTDR4103		\$389	E2	84.0	6.2	29	10.99	5,13	A436	
	3600	208-230/460	56H	NONE	K025	056T34D5304	✓	\$382	F1	80.0	6.4-6.2/3.1	24	10.44	5,68	A435	
	3600	575	145T	NONE	U906	145TTDR4005		\$389	E2	84.0	2.2	31	10.99	5,13	A436	
	1800	200-208	145T	NONE	E903	145TTDR5633	✓	\$357	E2	84.0	6.7-6.6	43	12.99	5,13	A436	
	1800	200-208	145T	AUTO	U422	145TTDR4134	✓	\$485	E2	84.0	6.7-6.6	43	12.99	5,13	A436	
	1800	208-230/460	56H	NONE	K041	056T17D5310	✓	\$357	F1	81.5	6.2-6.2/3.1	33	11.94	5,68	A436	
	1800	208-230/460	56HZ	AUTO	K065	056T17D3303	✓	\$427	F1	81.5	6.2-6.2/3.1	35	11.99	Z,5,68	A436	
	1800	208-230/460	56HZ	AUTO	K069	056T17D3307	✓	\$440	F1	81.5	6.2-6.2/3.1	34	11.99	VC,Z,5,68	A436	
	1800	208-230/460	145T	AUTO	U423A	145TTDR6132	✓	\$568	E2	86.5	6.2-6.0/3.0	56	12.49	5,13,68	A436	
	1800	208-230/460	145T	AUTO	U424A	145TTDR6133	✓	\$588	E2	86.5	6.2-6.0/3.0	56	12.99	VC,5,13,68	A436	
3	1800	575	56H	NONE	K062	056T17D5370	✓	\$357	F1	81.5	2.5	33	11.94	5	A436	
	1800	575	145T	NONE	E914	145TTDR5665	✓	\$357	E2	84.0	2.3	43	12.99	5,13	A436	
	1800	575	145T	NONE	E914A	145TTDR16062	✓	\$547	E2	86.5	2.4	37	13.62		A600	
	1800	575	145T	AUTO	U924	145TTDR4136		\$485	E2	84.0	2.3	42	12.99	5,13	A436	
	1800	575	145T	AUTO	U924A	145TTDR16059		\$568	E2	86.5	2.4	56	13.49	5,13	A436	
	1200	200	184T	NONE	E918	184TTDR4178		\$549	E2	85.5	7.15	89	15.22	13,25	A666	
	900	230/460	213T	NONE	H184A	213TTDW14102		\$877	E2	85.5	8.0/4.0	142	17.30		A606	
	3600	200	145T	NONE	E919	145TTDR4003		\$408	E2	84.0	10.0	33	11.49	5,13	A436	
	3600	208-230/460	56H	NONE	K048	056T34D5340		\$424	F1	84.0	8.8-8.2/4.1	32	11.44	5	A436	
	3600	575	145T	NONE	E932	145TTDR4105		\$408	E2	84.0	3.5	33	11.49	5,13	A436	

Catalog numbers (Cat No.) highlighted in bold blue have efficiency levels that meet EISA requirements

Continued on next page.

General Purpose, Three Phase

Dripproof, Rigid Base

HP	RPM	VOLTS	FRAME	OVER LOAD	CAT. NO.	MODEL NO.	STOCK	LIST PRICE	MULT. SYMB.	NOM. EFF.	F.L. AMPS	WT.	"C" DIM.	FOOT NOTES	C-FACE KITS
3	1800	200	182T	NONE	E1904	182TTDW4027	✓	\$418	E2	86.5	10.1	60	12.69	13,25,CF	A666
	1800	200-208	182T	AUTO	U1425	182TTDW4074	✓	\$571	E2	86.5	9.6-9.7	62	12.69	13	A666
	1800	200-208	182T	AUTO	U425B	182TTDW16048		\$668	E2	89.5	9.0-8.9	71	13.19	13	A666
	1800	208-230/460	56HZ	NONE	H803	056T17D5398	✓	\$389	F1	84.0	9.2-8.6/4.3	47	13.49	Z,13,68	A436
	1800	208-230/460	56HZ	AUTO	K066	056T17D3304	✓	\$436	F1	84.0	9.2-8.6/4.3	47	13.49	Z,5,68	A436
	1800	208-230/460	56HZ	AUTO	K080	056T17D3308	✓	\$450	F1	84.0	9.2-8.6/4.3	47	13.99	VC,Z,5,68	A436
	1800	208-230/460	182T	AUTO	U426B	182TTDW16049	✓	\$668	E2	89.5	8.6-8.0/4.0	72	13.19	13	A666
	1800	575	182T	NONE	E1915	182TTDW4030		\$418	E2	86.5	3.5	60	12.69	13	A666
	1800	575	182T	AUTO	U925	182TTDR4075		\$571	E2	86.5	3.5	78	14.22	d, 25	N/A
	1800	575	182T	AUTO	U925A	182TTDW16082		\$668	E2	89.5	3.2	87	14.19	13,25	A666
1200	200	213T	NONE	U907	213TTDW4078	✓	\$743	E2	86.5	9.65	121	17.30		A606	
900	230/460	215T	NONE	H185A	215TTDW14110		\$1,096	E2	86.5	10.0/5.0	225	18.55		A606	
5	3600	200	182T	NONE	E933	182TTDR4104		\$468	E2	86.5	13.8	74	13.72	25	N/A
	3600	575	182T	NONE	U908	182TTDR4106		\$468	E2	85.5	4.8	83	13.72	25	N/A
	1800	200	184T	NONE	E1905	184TTDW4027	✓	\$454	E2	87.5	15.6	79	13.19	13	A666
	1800	200-208	184T	AUTO	U427A	184TTDW4153	✓	\$647	E2	87.5	15.0/14.7	77	13.19	13	A666
	1800	208-230/460	184T	AUTO	U428B	184TTDW16038	✓	\$756	E2	89.5	13.6-12.6/6.3	75	14.19	13,68	A666
	1800	575	184T	NONE	E1916	184TTDW4030	✓	\$454	E2	87.5	5.3	79	13.19	13	A666
	1800	575	184T	AUTO	U917	184TTDW16041		\$647	E2	89.5	5.1	82	14.19	13	A666
	1200	200	215T	NONE	E935	215TTDW4078	✓	\$865	E2	87.5	16.1	145	18.55	13	A606
	900	230/460	254T	NONE	H186A	254TTDX14104	✓	\$1,515	E2	87.5	17.6/8.8	133	20.57		A612
	7 1/2	3600	200	184T	NONE	E937A	184TTDW4003		\$606	E2	87.5	20.3	68	14.19	13,25
3600		575	184T	NONE	E938	184TTDR4105		\$606	E2	87.5	7.0	78	14.72		A666
1800		200	213T	NONE	E906	213TTDBA4028	✓	\$632	E2	88.5	24.9	114	17.30	13,25	A606
1800		200-208	213T	AUTO	U429	213TTDW4070		\$921	E2	88.5	22.1-21.2	118	18.04	13	A606
1800		208-230/460	213T	AUTO	U430A	213TTDW16060	✓	\$1,078	E2	91.0	21.0-19.2/9.6	135	19.29	13,68	A606
1800		575	213T	NONE	E758	213TTDW4030		\$632	E2	88.5	7.7	113	17.30	13	A606
1800		575	213T	AUTO	U926	213TTDW4071		\$921	E2	88.5	7.7	118	17.30	13	A606
1800		575	213T	AUTO	U926A	213TTDW16061		\$1,078	E2	91.0	7.7	125	19.29	13	A606
900		230/460	256T	NONE	H187	256TTDX7101	✓	\$1,790	E6	84.0	26.0/13.0	148	22.32	d	A612
900		230/460	256T	NONE	H187A	256TTDN14102	✓	\$1,925	E2	88.5	22.0/11.0	162	24.37		N/A
10	3600	200	213T	NONE	E939	213TTDW4003		\$787	E2	88.5	26.9	120	17.30	13	A606
	1800	200	215T	NONE	E907	215TTDW4028	✓	\$811	E2	89.5	28.8	125	17.30	13	A606
	1800	575	215T	NONE	E759	215TTDW4030		\$811	E2	89.5	10.0	123	17.30	13	A606
	1200	230/460	256T	NONE	E734	256TTDX4076	✓	\$1,261	E2	90.2	28.0/14.0	178	22.32		A612
	900	230/460	284T	NONE	H188A	284TTDN14102		\$2,284	E2	89.5	38.5/19.2	328	24.94		A610
15	3600	200	215T	NONE	E788	215TTDW4003	✓	\$1,210	E2	90.2	39.1	120	18.55	13	A606
	1800	200	254T	NONE	E908	254TTDX4028	✓	\$1,215	E2	91.0	44.2	208	22.32		A612
	1800	575	254T	NONE	E760	254TTDX4030	✓	\$1,215	E2	91.0	15.4	184	22.32		A612
	900	230/460	286T	NONE	H189A	286TTDN14101		\$3,003	E2	89.5	42.0/21.0	361	26.81		A610
20	3600	200	254T	NONE	U900	254TTDX4018		\$1,426	E2	91.0	53.1	214	20.57		A612
	1800	200	256T	NONE	E909	256TTDX4027	✓	\$1,484	E2	91.0	60.0	227	22.32		A612
	1800	575	256T	NONE	E761	256TTDX4032		\$1,484	E2	91.0	20.8	198	22.32		A612
25	3600	200	256T	NONE	E786	256TTDX4013	✓	\$1,740	E2	91.0	66.5	200	22.32		A612
	1800	200	284T	NONE	E910	284TTDP4029	✓	\$1,723	E2	91.7	70.0	350	23.49		A610
	1800	575	284T	NONE	E762	284TTDP4035		\$1,723	E2	91.7	24.4	351	23.49		A610
	900	230/460	326T	NONE	H191A	326TTDR14105		\$4,283	E2	90.2	73.0/36.5	565	28.50		A613

GENERAL PURPOSE THREE PHASE

Catalog numbers (Cat No.) highlighted in bold blue have efficiency levels that meet EISA requirements

Blue shaded areas are Cast Iron Frames

Continued on next page.

General Purpose, Three Phase

Dripproof, Rigid Base

HP	RPM	VOLTS	FRAME	OVER LOAD	CAT. NO.	MODEL NO.	STOCK	LIST PRICE	MULT. SYMB.	NOM. EFF.	F.L. AMPS	WT.	"C" DIM.	FOOT NOTES	C-FACE KITS
30	3600	200	284TS	NONE	U901	284TSTDP4004		\$2,076	E2	91.0	83.0	320	22.06		A610
	1800	200	286T	NONE	E911	286TTDP4027	✓	\$2,004	E2	92.4	83.0	350	24.99		A610
	1800	575	286T	NONE	E763	286TTDP4034		\$2,004	E2	92.4	28.8	285	24.99		A610
40	3600	200	286TS	NONE	U902	286TSTDP4017		\$2,658	E2	91.7	108	460	23.56		A610
	1800	200	324T	NONE	E787	324TTDP4030	✓	\$2,493	E2	93.0	112	542	26.00		A613
	1800	575	324T	NONE	E764	324TTDP4028		\$2,493	E2	93.0	39.0	474	26.00		A613
50	3600	200	324TS	NONE	U909	324TSTDP4006		\$3,158	E2	92.4	135	385	24.50		A613
	1800	200	326T	NONE	E790	326TTDP4046		\$2,906	E2	93.0	142	499	27.50		A613
	1800	575	326T	NONE	E765	326TTDP4048		\$2,906	E2	93.0	49.0	496	27.50		A613
60	3600	200	326TS	NONE	U910	326TSTDP4003		\$3,591	E2	93.0	155	398	26.00		A613
	1800	575	364T	NONE	E766	364TTDS4040		\$3,562	E2	93.6	57.5	699	28.62	d	A216
75	1800	575	365T	NONE	E767	365TTDS4041		\$4,338	E2	94.1	71.0	730	29.62		A216
100	1800	575	404T	NONE	U903	404TTDS4042		\$5,532	E2	94.1	94.5	1004	32.50		A222
125	1800	575	405T	NONE	U904	405TTDS4049		\$6,624	E2	94.5	118	1083	34.00		A222
150	1800	575	444T	NONE	U911	444TTDS4069		\$9,566	E2	95.0	141	1321	37.75		A228
200	1800	575	445T	NONE	U912	445TTDS4070		\$12,085	E2	95.0	186	1447	39.75		A228
250	3600	460	445TS	NONE	E757	445TSTDS4001	✓	\$17,697	E2	94.5	279	1406	36.00	PW,68	A231
	1800	460	445T	NONE	E745	445TTDS4037		\$14,420	E2	95.4	287	1561	39.75	PW,RB	A228
	1200	460	447T	NONE	H822A	447TTDN14087		\$15,156	E2	95.4	308	2345	43.25	F,RB,YD,25	N/A
300	3600	460	447TS	NONE	H178	447TSTDN7001	✓	\$16,918	E6	95.0	332	1940	39.50	F,YD,68	A293
	1800	460	447TS	NONE	H812	447TSTDN7026	✓	\$15,976	E6	95.4	345	1994	39.50	F,YD,68	A293
	1200	460	449T	TSTAT	H820	449TTDN7086		\$16,360	E6	95.4	357	2632	48.25	F,YD,17,25	N/A
350	3600	460	447TS	NONE	H193	447TSTDN7003	✓	\$19,379	E6	95.0	385	2013	39.50	F,YD,68	A293
	1800	460	447TS	NONE	H813	447TSTDN7027	✓	\$17,363	E6	95.4	400	2064	39.50	F,YD,68	A293
	1200	460	449T	TSTAT	H821A	449TTDN14078		\$23,628	E2	95.4	420	2145	48.25	F,YD,17,25	N/A
400	3600	460	447TS	NONE	H817	447TSTDN7005	✓	\$22,049	E6	95.4	440	2150	39.50	F,YD,68	A293
	1800	460	447TS	NONE	H814	447TSTDN7028	✓	\$20,152	E6	95.4	450	2220	39.50	F,YD	A293
450	3600	460	449TS	TSTAT	H818	449TSTDN7001	✓	\$23,550	E6	95.8	502	2544	44.50	F,YD,68	A293
	1800	460	449TS	TSTAT	H815A	449TSTDN14033		\$23,169	E6	95.8	505	2695	44.50	F,YD	A293
500	3600	460	449TS	TSTAT	H819A	449TSTDN14005	✓	\$28,591	E6	95.8	546	2737	44.50	F,YD	A293
	1800	460	449TS	TSTAT	H816	449TSTDN7027		\$23,599	E6	95.8	560	2695	44.50	F,YD	A293

Catalog numbers (Cat No.) highlighted in bold blue have efficiency levels that meet EISA requirements

Blue shaded areas are Cast Iron Frames

GENERAL PURPOSE THREE PHASE

General Purpose, Three Phase Dripproof

Features:

- Ball bearings, mechanically locked on shaft end
- NEMA Service Factors
- UL Recognized and CSA Certified



C-Face Footless

Suitable for use on VFD per guidelines on page 17.

HP	RPM	VOLTS	FRAME	CAT. NO.	MODEL NO.	STOCK	LIST PRICE	MULT. SYMB.	NOM. EFF.	F.L. AMPS	WT.	"C" DIM.	FOOT NOTES
1/4	1800	208-230/460	56C	K247	5K49DN4132	✓	\$205	F1	67.4	1.1-1.2/0.6	17	9.52	17,68
1/3	3600	208-230/460	56C	KG215	5K35FN55	✓	\$177	F1	61.0	1.5-1.8/0.9	14	9.90	68,115
	1800	208-230/460	56C	K248	5K49FN4138	✓	\$237	F1	69.2	1.5-1.6/0.8	20	9.52	68
1/2	3600	208-230/460	56C	K216	5K36JN57	✓	\$201	F1	69.8	2.0-2.0/1.0	16	10.31	68,114
	1800	208-230/460	56C	K249	5K42HN4127	✓	\$267	F1	74.7	2.3-2.2/1.1	19	9.90	68
	1800	575	56C	G242	056T17D2115	✓	\$267	F1	68.0	0.9	17	10.30	
3/4	1200	208-230/460	56C	K1299	5K46MN6018	✓	\$353	F1	72.0	2.4-2.7/1.4	23	10.44	68
	3600	208-230/460	56C	G205	056T34D5327		\$242	F1	74.0	3.0-3.2/1.6	20	10.44	68
	3600	208-230/460	56C	K218	5K37MN37	✓	\$242	F1	74.0	2.6-2.6/1.3	17	10.70	48,68,113
	1800	208-230/460	56C	K250	5K46KN4125	✓	\$298	F1	74.3	2.7-2.8/1.4	24	10.80	
1	1800	575	56C	G243	056T17D2116	✓	\$298	F1	75.5	1.1	19	10.80	d
	1200	208-230/460	56C	K1300	5K49PN6019	✓	\$365	F1	76.1	2.9-2.8/1.4	26	11.38	
	3600	208-230/460	56C	K220	5K38PN47	✓	\$275	F1	74.0	3.3-3.2/1.6	36	11.30	48,68,112
	1800	208-230/460	56C	K251	5K46MN4126	✓	\$304	F1	79.2	3.6-3.8/1.9	24	10.73	
	1800	208-230/460	143TC	K634A	143TTDR14049	✓	\$384	E2	82.5	3.3-3.1/1.55	34	12.49	
1 1/2	1800	575	56C	G244	056T17D2127		\$304	F1	77.0	1.4	23	11.30	
	1200	208-230/460	145TC	C150A	145TTDR14088	✓	\$475	E2	80.0	3.8-3.6/1.8	43	13.49	68
	3600	208-230/460	56C	K222	5K46KN2173	✓	\$335	F1	80.0	5.0-4.8/2.4	24	10.73	48,68,111
	3600	208-230/460	143TC	K2018	5KE49PN8418	✓	\$417	E6	82.5	4.4-4.0/2.0	35	11.50	
	1800	208-230/460	56C	K521	5K49PN4120	✓	\$336	F1	79.8	5.8-5.6/2.8	31	11.33	
	1800	208-230/460	145TC	K622	5K49RN8424	✓	\$383	E6	82.1	5.2/2.6	33	11.95	d
	1800	208-230/460	145TC	K622A	145TTDR14049	✓	\$412	E2	84.0	4.6-4.4/2.2	41	12.49	
2	1200	208-230/460	145TC	C162A	145TTDR14087		\$497	E2	84.0	5.45-5.4/2.7	51	12.49	68
	3600	208-230/460	145TC	C102A	145TTDR14007	✓	\$475	E2	84.0	5.4/2.7	34	10.99	68
	3600	208-230/460	56C	K224	5K49NN2180	✓	\$392	F1	80.0	6.0-6.0/3.0	27	11.33	48,68,110
	1800	208-230/460	56C	K644	5K49ZN4611	✓	\$369	F1	83.8	6.6-6.4/3.2	49	13.81	
	1800	208-230/460	145TC	C122A	145TTDR4341	✓	\$444	E2	84.0	6.2-5.8/2.9	42	11.99	68
	1800	208-230/460	145TC	K2043	5KE49UN8428	✓	\$483	E6	84.0	6.4-6.0/3.0	40	12.62	24,68
	1200	230/460	184TC	C152A	184TTDW14078		\$572	E2	85.5	6.8/3.4	28	13.28	13,68
3	3600	208-230/460	56C	G289	056T34D5339		\$440	F1	84.0	8.9-8.4/4.2	31	11.44	68
	3600	208-230/460	56C	K226	5K48TN2182	✓	\$440	F1	84.0	8.9-8.4/4.2	38	12.61	18,48,68
	3600	208-230/460	145TC	C103	145TTDR5312	✓	\$485	E6	84.0	8.9-8.4/4.2	32	11.49	68
	1800	208-230/460	182TC	C123	182TTDR8067	✓	\$494	E6	81.5	9.2-9.0/4.5	67	14.28	d,68
	1800	208-230/460	182TC	C123B	182TTDW4028	✓	\$531	E2	86.5	9-8.8/4.4	63	12.78	13,68
5	3600	208-230/460	182TC	C104B	182TTDW14008	✓	\$662	E2	85.5	14.0-12.4/6.2	65	13.73	13,68
	1800	208-230/460	184TC	C124B	184TTDW14027	✓	\$580	E2	87.5	13.2/6.6	87	13.28	13,68
7 1/2	3600	208-230/460	184TC	C105B	184TTDW14017	✓	\$758	E2	87.5	20.0-17.6/8.8	74	14.28	13,68
	1800	208-230/460	213TC	C125A	213TTDW14057		\$767	E2	88.5	21.0-19.0/9.5	148	18.03	68
	1200	208-230/460	254TC	C155A	254TTDX14089		\$1,233	E2	88.5	23.0-21.4/10.7	217	20.92	68
10	3600	208-230/460	213TC	C106A	213TTDW14014	✓	\$934	E2	88.5	26.0-23.4/11.7	105	18.03	68
	1800	208-230/460	215TC	C126A	215TTDW14071		\$930	E2	89.5	28.0-25.0/12.5	124	18.03	68
	1200	230/460	256TC	C156A	256TTDX14087		\$1,398	E2	90.2	28.0/14.0	201	22.67	68

GENERAL PURPOSE THREE PHASE

General Purpose, Three Phase Drip Proof

Applications: General purpose use on gear reducers, pumps, machine tools, and other direct coupled equipment installed in environments that are relatively clean and dry. For use outdoors an enclosure or drip cover may be required (see Accessories section).

Features:

- Ball bearings, mechanically locked on shaft end (excludes 5K models)
- NEMA Service Factors
- UL Recognized and CSA Certified



C-Face Footed (Rigid Base)

Suitable for use on VFD per guidelines on page 17.

HP	RPM	VOLTS	FRAME	CAT. NO.	MODEL NO.	STOCK	CT SPEED RANGE*	LIST PRICE	MULT. SYMB.	NOM. EFF.	F.L. AMPS	WT.	"C" DIM.	FOOT NOTES
1/3	1800	208-230/460	56C	K1305	5K42FN4033	✓	----	\$259	F1	69.2	1.5-1.6/0.8	17	9.95	
1/2	3600	208-230/460	56C	K1306	5K49FN2045	✓	----	\$245	F1	65.5	2.2-2.5/1.3	19	10.38	114
	1800	208-230/460	56C	K1307	5K42HN4032	✓	----	\$289	F1	74.7	2.3-2.2/1.1	19	9.95	68
3/4	1800	208-230/460	56C	K1308	5K46KN4031	✓	----	\$320	F1	74.3	3.3-3.0/1.5	24	10.78	
1	1800	208-230/460	143TC	K2021	5KE49PN8391		----	\$347	E2	82.5	3.2-3.1/1.55	34	11.50	
	1800	208-230/460	56HC	K635	5K46MN4623	✓	----	\$325	F1	79.2	3.6-3.8/1.9	27	10.78	
1 1/2	3600	208-230/460	56C	K690	5K46HN2546	✓	----	\$356	F1	80.0	5.2-5.0/2.5	22	10.44	
	1800	208-230/460	145TC	K2022	5KE49TN8401	✓	----	\$356	E2	84.0	4.5-4.4/2.2	39	12.03	
2	1800	208-230/460	56HC	K646	5K49RN4617	✓	----	\$357	F1	82.1	5.2/2.6	33	11.91	
	3600	208-230/460	56C	K1311	5K49NN2046	✓	----	\$414	F1	80.5	6.6-6.0/3.0	27	11.38	
2	1800	208-230/460	145TC	K2023	5KE49UN8407	✓	----	\$401	E2	84.0	6.4-6.0/3.0	42	13.34	
	1800	208-230/460	56HC	K648	5K49ZN4616	✓	----	\$390	F1	83.6	6.2-5.8/2.9	49	13.86	
3	3600	230/460	145TC	U401A	145TTDR16308	✓	2:1	\$572	E2	86.5	7.2/3.6	45	12.69	68
	1800	230/460	182TC	U410A	182TTDW16059	✓	2:1	\$624	E2	89.5	8.0/4.0	76	14.19	13,68
5	3600	208-230/460	182TC	U402C	182TTDW16010	✓	2:1	\$788	E2	86.5	13.4-12.4/6.2	65	13.20	13,68
	1800	230/460	184TC	U403A	184TTDW16043		2:1	\$771	E2	89.5	13.6-12/6.3	89	14.20	13,68
7 1/2	3600	208-230/460	184TC	U404B	184TTDW16001		2:1	\$1,061	E2	88.5	17.8/8.9	85	14.20	13,68
	1800	230/460	213TC	U405A	213TTDW16063	✓	2:1	\$1,048	E2	91.0	16.2/8.1	168	18.03	68
10	3600	230/460	213TC	U432A	213TTDW16010		2:1	\$1,083	E2	89.5	23.4/11.7	127	18.03	YD,68
	1800	208-230/460	215TC	U433A	215TTDW16061		2:1	\$1,246	E2	91.7	27.0-25.0/12.5	185	19.28	YD,68
15	3600	230/460	215TC	U435	215TTDW4315		2:1	\$1,349	E2	90.2	34.0/17.0	128	19.28	YD,13,68
	1800	208-230/460	254TC	U436A	254TTDN16056	✓	2:1	\$1,641	E2	93.0	37.0/18.5	221	23.31	YD,68
20	3600	230/460	254TC	U437	254TTDX4315		2:1	\$1,615	E2	91.0	46.0/23.1	200	20.89	YD,68
	1800	208-230/460	256TC	U438A	256TTDN16049		2:1	\$1,955	E2	93.0	59.0-55.0/27.5	235	24.81	YD,68
25	3600	230/460	256TC	U439A	256TTDN16009		2:1	\$2,255	E2	91.7	58.0/29.0	243	24.81	YD,68
	1800	230/460	284TSC	U440A	286TSTDN16034		2:1	\$2,365	E2	93.6	61.0/30.5	356	14.50	YD,68
30	3600	230/460	284TSC	U441A	286TSTDN16005	✓	2:1	\$2,780	E2	91.7	67.5/34	234	25.44	YD,68
	1800	230/460	286TSC	U442A	286TSTDN16033		2:1	\$2,694	E2	94.1	73.0/36.5	376	25.44	YD,68
40	3600	230/460	286TSC	U443A	286TSTDN16004		2:1	\$3,458	E2	92.4	90.0/45.0	354	25.44	YD,68
	1800	230/460	324TSC	U444A	324TSTDP16032		----	\$3,418	E2	94.1	94.0/47.0	465	24.50	YD,68
50	3600	230/460	324TSC	U445A	324TSTDP16002	✓	----	\$4,196	E2	93.0	112/56.0	443	24.50	YD,68
	1800	230/460	326TSC	U446A	326TSTDR16035		----	\$3,901	E2	94.5	121/60.5	453	27.00	YD,68
60	3600	230/460	326TSC	U447A	326TSTDP16005	✓	----	\$4,703	E2	93.6	135/67.5	366	26.00	YD,68
	1800	230/460	364TSC	U448A	365TSTDS16044		----	\$4,894	E2	95.0	139/69.5	748	26.50	YD,68
75	3600	230/460	364TSC	U449A	365TSTDS16008		----	\$6,832	E2	93.6	170/85.0	732	27.50	YD,68
	1800	230/460	365TSC	U450A	365TSTDS6074		----	\$5,801	E2	95.0	174/87.0	803	27.50	YD,68
100	3600	230/460	365TSC	U451A	365TSTDS16005		----	\$8,081	E2	93.6	230/115	799	27.50	YD,68
	1800	230/460	404TSC	U452A	404TSTDS6327		----	\$7,556	E2	95.4	226/113	1056	29.50	YD,68
125	3600	460	404TSC	U453A	404TSTDS16006	✓	----	\$9,719	E2	94.1	138	991	29.50	YD,68
	1800	460	405TSC	U454A	405TSTDS16039		----	\$8,833	E2	95.4	141	1132	29.50	YD,68
150	3600	460	405TSC	U455A	405TSTDS16005		----	\$12,214	E2	94.1	165	1034	31.00	YD,68
	1800	460	444TSC	U456A	444TSTDS16034		----	\$12,379	E2	95.8	170	1376	34.00	YD,13,68

Catalog numbers (Cat No.) highlighted in bold blue have efficiency levels that meet EISA requirements

Blue shaded areas are Cast Iron Frames

* Requires nameplate modification

General Purpose, Three Phase Dripproof, NEMA Premium® XRI® Efficiency

Applications:

General purpose use on compressors, pumps, conveyors, blowers, and other machinery in environments that are relatively clean and dry. Substantial energy savings can be realized when using these high efficiency motors. Guaranteed efficiencies offer an eXtra Return on your Investment when using these premium efficiency motors on high cycle or long run time applications.

Features:

Meets or exceeds NEMA Premium® efficiencies

NEMA Premium® models are in compliance with EISA2007

- Motors are suitable for 10:1 VT on all frame sizes and 10:1 CT up to 365T frame (Except where noted)
- 1.15 Service Factor
- Normally closed thermostats, as noted
- Class F Insulation
- Nameplated 60/50 hertz
- UL Recognized, CSA Certified and CE Marked
- Three year warranty



Rigid Base

Suitable for use on VFD per guidelines on page 17.

HP	RPM	VOLTS	FRAME	CAT. NO.	MODEL NO.	STOCK	LIST PRICE	MULT. SYMB.	NOM. EFF.	F.L. AMPS	WEIGHT	"C" DIM.	FOOT NOTES	C FACE KIT
1	3600	208-230/460	56H	U244	056T17D6001	✓	\$406	E2	80.0	2.8-3.4/1.4	24	10.18	13,TS	A435
	1800	208-230/460	143T	U758	143TTDR6027	✓	\$463	E2	85.5	3.2/1.6	30	12.12	TS	A600
	1800	208-230/460	143T	U758-P	143TTDR16052	✓	\$488	E2	85.5	3.5-3.2/1.6	30	12.50	P	A436
	1800	575	143T	E912A	143TTDR16037	✓	\$463	E2	85.5	1.3	30	12.12		A600
	1200	208-230/460	145T	U265	145TTDR6076	✓	\$539	E2	82.5	3.8-4.4/2.2	41	12.62	TS	A600
	1200	575	145T	E934A	145TTDR16077	✓	\$539	E2	82.5	1.8	41	12.62		A600
	1 1/2	3600	208-230/460	143T	U245	143TTDR6028	✓	\$452	E2	84.0	4.4-4.0/2.0	36	12.28	TS
1 1/2	3600	575	143T	E798A	143TTDR16005	✓	\$452	E2	84.0	1.6	36	12.28		A600
	1800	208-230/460	145T	U759	145TTDR6028	✓	\$483	E2	86.5	4.8-5.6/2.4	35	12.62	TS	A600
	1800	208-230/460	145T	U759-P	145TTDR16348	✓	\$510	E2	86.5	4.8-5.6/2.4	35	13.00	P	A436
	1800	575	145T	E913A	145TTDR16061	✓	\$483	E2	86.5	1.8	35	12.62		A600
	1200	208-230/460	182T	U1266	182TTDW6076	✓	\$634	E2	86.5	6.2/3.1	68	13.19	13,TS	A666
	1200	575	182T	U914	182TTDW16009	✓	\$634	E2	86.5	2.5	68	13.19	13	A666
	2	3600	208-230/460	145T	U246	145TTDR6039	✓	\$533	E2	85.5	5.2-4.8/2.4	43	13.12	TS
3600		575	145T	U906A	145TTDR16008	✓	\$533	E2	85.5	2.1	43	13.12		A436
1800		208-230/460	145T	U760	145TTDR6029	✓	\$547	E2	86.5	5.8/2.9	37	13.62	TS	A600
1800		208-230/460	145T	U760-P	145TTDR16349	✓	\$577	E2	86.5	6.4-5.8/2.9	37	14.00	P	A436
1800		575	145T	E914A	145TTDR16062	✓	\$547	E2	86.5	2.4	37	13.62		A600
1200		208-230/460	184T	U1267	184TTDW6076	✓	\$646	E2	87.5	7.2/3.6	90	15.19	13,TS	A666
1200		575	184T	U915	184TTDW16076	✓	\$646	E2	87.5	2.9	90	15.19	13	A666
3	3600	208-230/460	145T	U247	145TTDR6002	✓	\$539	E2	86.5	8.0-7.2/3.6	45	13.12	TS	A600
	3600	575	145T	E932A	145TTDR16010	✓	\$539	E2	86.5	2.9	45	13.12		A600
	1800	208-230/460	182T	E1930	182TTDW6030	✓	\$561	E2	89.5	8.4-8.0/4.0	76	14.19	13,TS	A666
	1800	208-230/460	182T	E1930-P	182TTDW16063	✓	\$592	E2	89.5	8.4-8.0/4.0	76	14.56	13,P	A666
	1800	575	182T	E915B	182TTDW16029	✓	\$561	E2	89.5	3.4	76	14.19	13	A666
	1200	208-230/460	213T	U268	213TTDC6076	✓	\$886	E2	88.5	10.2-10.0/5.0	156	16.38		A602
	1200	575	213T	U279	213TTDC6079	✓	\$886	E2	88.5	4.0	156	16.38		A602

Catalog numbers (Cat No.) highlighted in bold blue have efficiency levels that meet EISA requirements

Blue shaded areas are Cast Iron Frames

Continued on next page.

General Purpose, Three Phase DripProof, NEMA Premium® XRI® Efficiency

Rigid Base

HP	RPM	VOLTS	FRAME	CAT. NO.	MODEL NO.	STOCK	LIST PRICE	MULT. SYMB.	NOM. EFF.	F.L. AMPS	WEIGHT	"C" DIM.	FOOT NOTES	C FACE KIT
5	3600	208-230/460	182T	U1248	182TTDW6001	√	\$591	E2	86.5	13.0-12.0/6.0	86	15.19	13,TS	A666
	3600	575	182T	U908A	182TTDW16008	√	\$591	E2	86.5	5.6	86	13.19	13	A666
	1800	208-230/460	184T	E1931	184TTDW6031	√	\$631	E2	89.5	13.6-12.8/6.4	89	14.19	13,TS	A666
	1800	208-230/460	184T	E1931-P	184TTDW16061	√	\$665	E2	89.5	13.6-12.8/6.4	89	14.56	13,P	A666
	1800	575	184T	E916B	184TTDW16040	√	\$631	E2	89.5	5.3	89	14.19	13	A666
	1200	208-230/460	215T	U269	215TTDC6076	√	\$1,031	E2	90.2	15.8-15.0/7.5	185	16.38		A602
1200	575	215T	U280	215TTDC6079	√	\$1,031	E2	90.2	6.0	185	16.38		A602	
7 1/2	3600	208-230/460	184T	U249A	184TTDW6001	√	\$855	E2	88.5	19.6-17.6/8.8	106	16.19	13,TS	A666
	3600	575	184T	E938A	184TTDW16027	√	\$855	E2	88.5	7.0	106	16.19	13	A666
	1800	208-230/460	213T	U763	213TTDC6026	√	\$817	E2	91.0	20.6-19.8/9.9	160	16.38		A602
	1800	208-230/460	213T	U430A-P	213TTDW16075	√	\$862	E2	91.0	21.0-19.2/9.6	135	19.67	13,P	A606
	1800	575	213T	U281	213TTDC6029	√	\$817	E2	91.0	7.8	160	16.38		A602
	1200	230/460	254T	E733A	254TTDX16082	√	\$1,289	E2	92.4	21.0/10.5	240	22.40		N/A
1200	575	254T	U282	254TTDC6079	√	\$1,289	E2	92.4	8.1	281	20.94	YD	A622	
10	3600	208-230/460	213T	U764	213TTDC6001	√	\$932	E2	91.0	25.0-23.6/11.8	150	16.38		A602
	3600	575	213T	U283	213TTDC6003	√	\$932	E2	91.0	9.4	150	16.38		A602
	1800	208-230/460	215T	U431A-P	215TTDW16073	√	\$1,017	E2	91.7	29.0-26.2/13.1	175	22.15	13,P	A606
	1800	208-230/460	215T	U765	215TTDC6026	√	\$964	E2	91.7	28.5-25.6/12.8	220	17.87		A602
	1800	575	215T	U284	215TTDC6029	√	\$964	E2	91.7	10.0	220	17.87	A	A602
	1200	230/460	256T	E734A	256TTDX16078	√	\$1,607	E2	91.7	27.4/13.7	300	23.90		N/A
1200	575	256T	U285	256TTDC6079	√	\$1,607	E2	91.7	10.8	305	22.60	YD	A622	
15	3600	208-230/460	215T	U766	215TTDC6001	√	\$1,366	E2	91.0	38.0-34.6/17.3	184	17.87	99	A602
	3600	575	215T	U286	215TTDC6003	√	\$1,366	E2	91.0	13.8	184	17.87	99	A602
	1800	208-230/460	254T	U767	254TTDC6026	√	\$1,335	E2	93.0	40.5-37.0/18.5	310	20.94	A,YD	A622
	1800	230/460	254T	E722A	254TTDX16042	√	\$1,335	E2	93.0	38.0/18.9	230	22.10		N/A
	1800	230/460	254T	E722A-P	254TTDX16043	√	\$1,408	E2	93.0	38.0/18.9	230	22.50	P	N/A
	1800	575	254T	U287	254TTDC6029	√	\$1,335	E2	93.0	15.0	310	20.94	A,YD	A622
1200	230/460	284T	E1002	284TTDR16077	√	\$2,116	E2	91.7	43.0/21.5	340	24.30			
1200	208-230/460	284T	U256	284TTDC6076	√	\$2,116	E2	92.4	42.0-39.5/19.7	414	23.54	YD	A626	
1200	575	284T	U288	284TTDC6079	√	\$2,116	E2	92.4	16.0	414	23.54	YD	A626	
20	3600	230/460	254T	E708A	254TTDX16010	√	\$1,574	E2	91.0	48.0/24.0	243	22.10		N/A
	3600	208-230/460	254T	U768	254TTDC6001	√	\$1,574	E2	93.0	50.0-46.0/23.0	300	20.94	d,YD	A622
	3600	575	254T	U289	254TTDC6003	√	\$1,574	E2	93.0	18.4	300	20.94	YD	A622
	1800	230/460	256T	E723B	256TTDX16032	√	\$1,653	E2	93.6	49.0/24.5	259	22.10		N/A
	1800	230/460	256T	E723B-P	256TTDX16033	√	\$1,744	E2	93.6	49.0/24.5	259	22.50	P	N/A
	1800	208-230/460	256T	U769	256TTDC6026	√	\$1,653	E2	93.0	55.0-51.0/25.5	360	22.60	YD	A622
1800	575	256T	U290	256TTDC6029	√	\$1,653	E2	93.0	19.2	360	22.60	YD	A626	
25	3600	230/460	256T	E709A	256TTDX16006	√	\$2,004	E2	91.7	57.0/28.5	261	22.10		N/A
	3600	575	256T	U291	256TTDC6003	√	\$2,004	E2	93.0	23.0	315	22.60	YD	A626
	1800	230/460	284T	E1006	284TTDR16047	√	\$1,950	E2	93.6	70.2/35.1	292	24.30		N/A
	1800	230/460	284T	E1006-P	284TTDR16048	√	\$2,057	E2	93.6	70.2/35.1	292	24.68	P	N/A
	1800	208-230/460	284T	U771	284TTDC6026	√	\$1,950	E2	93.6	66.0-59.6/29.8	424	23.54	YD	A626
	1800	208-230/460	284TS	E793A	284TSTDN16031	√	\$1,950	E2	93.6	64.0/32.0	424	23.57		A287
1800	575	284T	E762A	284TTDC6029	√	\$1,950	E2	93.6	23.8	424	23.54	YD	A627	
1200	208-230/460	324T	U798	324TTDC6076	√	\$3,070	E2	93.0	72.0-67.0/33.5	695	26.02	d,YD	A627	
30	3600	230/460	284TS	E1008	284TSTDR16003	√	\$2,479	E2	91.7	69.0/34.5	270	22.90		N/A
	3600	575	284TS	U292	284TSTDC6003	√	\$2,479	E2	94.1	28.1	396	22.17	YD	A626
	1800	230/460	284T	E1009	286TTDR16037	√	\$2,250	E2	94.1	73.2/36.6	303	25.80		N/A
	1800	230/460	284T	E1009-P	286TTDR16038	√	\$2,374	E2	94.1	73.2/36.6	202	26.18	P	N/A
	1800	208-230/460	286T	U773	286TTDC6026	√	\$2,250	E2	94.1	78.0-71.0/35.5	483	25.00	d,YD	A626
	1800	208-230/460	286TS	E794A	286TSTDN16036	√	\$2,250	E2	94.1	78.0-71.0/35.5	483	25.44		A287
1800	575	286T	E763A	286TTDC6029	√	\$2,250	E2	94.1	28.6	483	25.00	YD	A627	

Catalog numbers (Cat No.) highlighted in bold blue have efficiency levels that meet EISA requirements

Blue shaded areas are Cast Iron Frames

Continued on next page.

General Purpose, Three Phase Drip Proof, NEMA Premium® XRI® Efficiency

Rigid Base

HP	RPM	VOLTS	FRAME	CAT. NO.	MODEL NO.	STOCK	LIST PRICE	MULT. SYMB.	NOM. EFF.	F.L. AMPS	WT.	"C" DIM.	FOOT NOTES	C FACE KIT	
40	3600	230/460	286TS	E1010	286TSTDR16002	✓	\$2,984	E2	92.4	103.5/51.8	369	22.90		N/A	
	3600	575	286TS	U293	286TSTDC6003	✓	\$2,984	E2	93.6	36.5	452	23.62	A,YD,99	A626	
40	1800	230/460	324T	U775-P	324TTDR16050	✓	\$2,984	E2	94.1	96.0/48.0	540	28.00	P	N/A	
	1800	208-230/460	326TS	E789A	326TSTDP16032	✓	\$2,828	E2	94.1	100/50.0	581	26.00		A613	
	1800	575	324T	E764A	324TTDC6029	✓	\$2,828	E2	94.1	38.0	581	26.02	YD	A627	
	1200	208-230/460	364T	U1927	364TTDCA6086	✓	\$4,619	E2	94.1	107-100/50.0	875	31.60	YD	A626	
	50	3600	575	324TS	U294	324TSTDC6003	✓	\$3,638	E2	94.1	44.8	548	24.53	YD	A627
	1800	208-230/460	326TS	E791A	326TSTDR16034	✓	\$3,369	E2	94.5	121/60.5	453	27.00		N/A	
40	1800	230/460	326T	E791A-P	326TTDR16063	✓	\$3,554	E2	94.5	121/60.5	453	27.38	P	N/A	
	1800	208-230/460	326T	U777	326TTDC6026	✓	\$3,369	E2	94.5	129-118/59.0	710	27.52	YD	A627	
	1800	575	326T	E765A	326TTDC6029	✓	\$3,369	E2	94.5	48.0	710	27.52	YD	A627	
	60	1800	208-230/460	364T	U1779	364TTDCA6060	✓	\$4,007	E2	95.4	151.5-140/70.0	1005	31.60	YD	A629
	1800	208-230/460	365TS	E768C	365TSTDS16042	✓	\$4,007	E2	95.4	153-139/69.5	1005	27.50		A219	
	1800	575	365T	E766A	365TTDS16067		\$4,007	E2	95.4	55.5	1005	29.62	YD	A216	
40	1200	230/460	404T	U270	404TTDS6086	✓	\$6,400	E2	95.0	146/73.0	975	32.50		A222	
	75	1800	230/460	365T	E921	365TTDS6060		\$4,799	E2	95.0	174/87.0	950	29.62	YD	A216
	1800	208-230/460	365TS	E782C	365TSTDS16041	✓	\$4,799	E2	95.0	194-174/87.0	1030	27.50		A219	
	1800	575	365T	E767A	365TTDS16064		\$4,799	E2	95.0	69.5	1030	29.62	YD	A216	
40	1200	230/460	405T	U271	405TTDS16081	✓	\$7,866	E2	95.0	180/90.0	1100	34.00		A222	
	100	1800	230/460	404T	E922	404TTDS6060	✓	\$6,256	E2	95.4	226/113	1025	32.50	YD	A222
	1800	230/460	404TS	E780A	404TSTDS16036	✓	\$6,256	E2	95.4	226/113	1025	29.50		A225	
	1800	575	404T	U903A	404TTDS16055		\$6,256	E2	95.4	90.5	1025	32.50	YD	A222	
40	1200	230/460	444T	U272	444TTDS16077	✓	\$9,764	E2	95.4	234/117	1300	37.75		A228	
	125	3600	460	404TS	U250	404TSTDS6001	✓	\$8,418	E2	95.0	140	973	29.50	YD	A225
	1800	460	405T	E923	405TTDS6060	✓	\$7,919	E2	95.4	141	1150	34.00	YD	A222	
	1800	460	405TS	E781A	405TSTDS16038	✓	\$7,919	E2	95.4	141	1150	31.00	PW	A225	
	1800	575	405T	U904A	405TTDS16060		\$7,919	E2	95.4	113	1150	34.00	YD	A222	
40	1200	460	445T	U273	445TTDS16076	✓	\$12,814	E2	95.0	145	1500	39.75	YD	A228	
	150	3600	460	405TS	U251	405TSTDS6007	✓	\$10,599	E2	95.0	165	1075	31.00	YD	A225
	1800	460	444T	E924	444TTDS6060	✓	\$10,631	E2	95.8	170	1275	37.75	YD	A228	
	1800	460	444TS	E792A	444TSTDS16038	✓	\$10,631	E2	95.8	170	1275	34.00	PW	A231	
	1800	575	444T	U911A	444TTDS16043		\$10,631	E2	95.8	170	1275	37.75	YD	A228	
40	1200	460	447T	U274	447TTDN16077	✓	\$13,175	E2	95.4	185	2050	43.25		N/A	
	200	3600	460	444TS	U252	444TSTDS16003	✓	\$15,323	E2	95.8	216	1277	34.00	YD	A231
	1800	460	445T	E925	445TTDS6060	✓	\$13,339	E2	95.8	225	1500	39.75	YD	A228	
	1800	460	445TS	U400A	445TSTDS16038	✓	\$13,339	E2	95.8	225	1500	36.00	PW	A231	
	1800	575	445T	U912A	445TTDS16041		\$13,339	E2	95.8	180	1500	39.75	YD	A228	
	1200	460	447T	E797A	447TTDN16085		\$15,730	E2	95.4	245	2200	43.25	RB	N/A	
	1200	460	449T	U275	449TTDN16076	✓	\$15,730	E2	95.4	245	2200	48.25	YD	N/A	
40	250	3600	460	447TS	U785	447TSTDN16004	✓	\$17,846	E2	95.8	274	1438	39.50	YD	A293
	1800	460	447T	U786	447TTDN16046	✓	\$16,478	E2	96.2	292	1438	43.25	YD	N/A	
40	300	3600	460	447TS	U788	447TSTDN16007	✓	\$20,819	E2	95.4	330	1745	39.50	YD	A293
	1800	460	447T	U789	447TTDN16041		\$18,660	E2	96.2	340	1745	43.25	YD	N/A	
	1200	460	449T	U790	449TTDN16077		\$24,663	E2	95.8	365	2112	48.25	YD	N/A	
40	350	3600	460	447TS	U791	447TSTDN16008	✓	\$22,900	E2	95.4	385	1745	39.50	YD	A293
40	400	3600	460	449TS	U793	449TSTDN16003	✓	\$26,471	E2	95.8	450	2112	44.50	YD	A293
40	450	3600	460	449TS	U795	449TSTDN16004	✓	\$33,459	E2	95.8	495	2112	44.50	YD	A293
40	500	3600	460	449TS	U797	449TSTDN16005	✓	\$37,275	E2	95.8	545	2147	44.50	YD	A293

GENERAL PURPOSE THREE PHASE

Catalog numbers (Cat No.) highlighted in bold blue have efficiency levels that meet EISA requirements

Blue shaded areas are Cast Iron Frames

General Purpose, Three Phase Globetrotter® NEMA Premium® Efficiency Dripproof

Features:

- ☛ Meets or exceeds NEMA Premium® efficiencies
NEMA Premium® models are in compliance with EISA2007
- 182T-215T models steel frame, 254T-449T models cast iron frame
- Inverter Duty 10:1 Variable Torque and 2:1 Constant Torque, 1.0 SF
- 1.15 Service Factor
- Class F Insulation
- Standard assembly F1, reversible to F2 assembly
- UL Recognized, CSA Certified, CE Mark
- Three year warranty



Rigid Base

Suitable for use on VFD per guidelines on page 17.

HP	RPM	VOLTS	FRAME	CAT. NO.	MODEL NO.	STOCK	LIST PRICE	MULT. SYMB.	NOM. EFF.	F.L. AMPS	WEIGHT	"C" DIM.	FOOT NOTES	C FACE KIT
1 1/2	1200	230/460	182T	GT0005	182TTDB6076	✓	\$623	E1	86.5	4.8-4.4/2.2	75	13.72		A160
2	1200	208-230/460	184T	GT0008	184TTDB6076	✓	\$634	E1	87.5	6.4-5.8/2.9	99	14.72		A160
3	1800	208-230/460	182T	GT0010	182TTDB6026	✓	\$551	E1	89.5	8.4-7.8/3.9	76	13.72		A160
	1200	230/460	213T	GT0011	213TTDB6076	✓	\$870	E1	88.5	9.2-8.8/4.4	156	17.52		A161
5	3600	208-230/460	182T	GT0012	182TTDB6001	✓	\$581	E1	86.5	13.2-11.8/5.9	126	13.72		A160
	1800	208-230/460	184T	GT0013	184TTDB6026	✓	\$620	E1	89.5	13.6-12.4/6.2	86	14.72		A160
	1200	230/460	215T	GT0014	215TTDB6076	✓	\$1,012	E1	89.5	15.2-14.0/7.0	281	17.52		A161
7 1/2	3600	208-230/460	184T	GT0015	184TTDB6001	✓	\$714	E1	88.5	19.0-17.0/8.5	143	14.72	A	A160
	1800	230/460	213T	GT0016	213TTDB6026	✓	\$802	E1	91.0	20.7-19.0/9.5	160	17.52		A161
10	1200	208-230/460	254T	GT0017	254TTDCA6076	✓	\$1,266	E1	90.2	22.0-21.0/10.5	281	22.64		A163
	3600	208-230/460	213T	GT0018	213TTDB6001	✓	\$916	E1	89.5	25.5-23.0/11.5	150	17.52		A161
	1800	230/460	215T	GT0019	215TTDB6026	✓	\$947	E1	91.7	26.9-25.0/12.5	220	17.52		A161
15	1200	208-230/460	256T	GT0020	256TTDCA6076	✓	\$1,578	E1	91.7	29.6-27.6/13.8	305	24.22		A163
	3600	208-230/460	215T	GT0021	215TTDB6001	✓	\$1,342	E1	90.2	38.0-34.0/17.0	184	17.52		A161
	1800	208-230/460	254T	GT0022	254TTDCA6026	✓	\$1,311	E1	93.0	40.0-38.0/19.0	310	22.64		A163
20	1200	208-230/460	284T	GT0023	284TTDCA6076	✓	\$2,078	E1	91.7	42.5-40.0/20.0	414	25.71	YD	A165
	3600	208-230/460	254T	GT0024	254TTDCA6001	✓	\$1,546	E1	91.0	51.0-46.0/23.0	300	22.64	YD	A162
	1800	208-230/460	256T	GT0025	256TTDCA6026	✓	\$1,623	E1	93.0	53.0-49.0/24.5	360	24.22	YD	A163
25	1200	208-230/460	286T	GT0026	286TTDCA6076	✓	\$2,532	E1	92.4	58.0-54.0/27.0	457	27.09	YD	A165
	3600	208-230/460	256T	GT0027	256TTDCA6001	✓	\$1,969	E1	91.7	64.0-57.0/28.5	315	24.22	YD	A162
	1800	208-230/460	284T	GT0028	284TTDCA6026	✓	\$1,915	E1	93.6	66.0-62.0/31.0	424	25.71	YD	A165
30	1200	208-230/460	324T	GT0029	324TTDCA6076	✓	\$3,016	E1	93.0	72.0-68.0/34.0	695	28.55	YD	A167
	3600	208-230/460	284TS	GT0030	284TSTDCA6001	✓	\$2,435	E1	91.7	76.0-68.0/34.0	396	24.41	YD	A164
	1800	208-230/460	286T	GT0031	286TTDCA6026	✓	\$2,210	E1	94.1	81.0-74.0/37.0	483	27.09	YD	A165
40	1200	208-230/460	326T	GT0032	326TTDCA6076	✓	\$3,535	E1	93.6	83.5-78.5/39.0	760	29.73	YD	A167
	3600	208-230/460	286TS	GT0033	286TSTDCA6001	✓	\$2,931	E1	92.4	100-90.0/45.0	452	25.79	YD	A164
	1800	208-230/460	324T	GT0034	324TTDCA6026	✓	\$2,777	E1	94.5	105-95.0/47.5	581	28.55	YD	A167
50	1200	208-230/460	364T	GT0035	364TTDCB6086	✓	\$4,537	E1	94.1	106-99.0/49.5	875	31.69	YD	A169
	3600	208-230/460	324TS	GT0036	324TSTDCA6001	✓	\$3,573	E1	93.0	124-93.0/46.5	548	27.05	YD	A166
	1800	208-230/460	326T	GT0037	326TTDCA6026	✓	\$3,310	E1	94.5	131-118/59.0	710	29.73	YD	A167
60	1200	208-230/460	365T	GT0038	365TTDCB6086	✓	\$5,223	E1	94.1	132-122/61.0	930	33.27	YD	A169
	3600	208-230/460	326TS	GT0039	326TSTDCA6001	✓	\$4,275	E1	93.6	148-134/67.0	590	28.23	YD	A166
	1800	208-230/460	364T	GT0040	364TTDCB6060	✓	\$3,935	E1	95.0	153-139/69.5	1005	31.69	YD	A169
1200	230/460	404T	GT0041	404TTDC6086	✓	\$6,286	E1	94.5	144/72.0	975	37.20	YD	A415	

Catalog numbers (Cat No.) highlighted in bold blue have efficiency levels that meet EISA requirements

Blue shaded areas are Cast Iron Frames

Continued on next page.

General Purpose, Three Phase Globetrotter® NEMA Premium® Efficiency Dripproof

Rigid Base

HP	RPM	VOLTS	FRAME	CAT. NO.	MODEL NO.	STOCK	LIST PRICE	MULT. SYMB.	NOM. EFF.	F.L. AMPS	WEIGHT	"C" DIM.	FOOT NOTES	C FACE KIT
75	3600	208-230/460	364TS	GT0042	364TSTDCB6001	✓	\$5,648	E1	93.6	184-166/83.0	937	29.57	YD	A168
	1800	208-230/460	365T	GT0043	365TTDCB6060	✓	\$4,713	E1	95.0	194-174/87.0	1030	33.27	YD	A168
	1200	230/460	405T	GT0044	405TTDC16081	✓	\$7,726	E1	94.5	180/90.0	1100	38.78	YD	A415
100	3600	208-230/460	365TS	GT0045	365TSTDCB6001	✓	\$6,912	E1	93.6	243-222/111	1016	31.14	YD	A168
	1800	230/460	404T	GT0046	404TTDC6060	✓	\$6,145	E1	95.4	226/113	1025	37.20	YD	A415
	1200	230/460	444T	GT0047	444TTDC16077	✓	\$9,591	E1	95.0	232/116	1675	44.57	YD	A417
125	3600	460	404TS	GT0048	404TSTDC6001	✓	\$8,269	E1	94.1	138	973	33.85	PW	A414
	1800	460	405T	GT0049	405TTDC6060	✓	\$7,778	E1	95.4	140	1150	38.78	PW	A415
	1200	460	445T	GT0050	445TTDC16076	✓	\$12,586	E1	95.0	145	1799	44.57	PW	A417
150	3600	460	405TS	GT0051	405TSTDC6007	✓	\$9,676	E1	94.1	164	1075	35.45	PW	A414
	1800	460	444T	GT0052	444TTDC6060	✓	\$10,442	E1	95.8	168	1275	44.57	PW	A417
	1200	460	447T	GT0053	447TTDC16077	✓	\$12,941	E1	95.4	172	2050	49.69	PW	A419
200	3600	460	444TS	GT0054	444TSTDC16003	✓	\$15,051	E1	95.0	215	1277	40.83	PW	A416
	1800	460	445T	GT0055	445TTDC6060	✓	\$13,102	E1	95.8	220	1885	44.57	PW	A417
	1200	460	449T	GT0056	449TTDC16076	✓	\$16,501	E1	95.4	228	2200	49.69	PW	A419

Catalog numbers (Cat No.) highlighted in bold blue have efficiency levels that meet EISA requirements

Blue shaded areas are Cast Iron Frames

General Purpose, Three Phase

Totally Enclosed

Applications:

General purpose use on pumps, fans, blowers, compressors, conveyors, and other industrial machinery installed in damp, dusty, or dirty environments. Additionally, cast iron frame motors may be suitable for the process industries.



Features:

- Frame constructions are heavy gauge steel or Aluminum, as noted
- Ball bearings (except as noted)
- 1.15 Service Factor (except as noted)
- 60/50 hertz at next lower horsepower, as noted
- Will accept C-Face Kits as noted, also see Accessories section
- UL Recognized and CSA Certified
- Two year warranty on EISA efficient motors (bold blue Catalog Numbers)



Rigid Base

Suitable for use on VFD per guidelines on page 17.

HP	RPM	VOLTS	FRAME	CAT. NO.	MODEL NO.	STOCK	CT SPEED RANGE*	LIST PRICE	MULT. SYMB.	NOM. EFF.	F.L. AMPS	WEIGHT	"C" DIM.	FOOT NOTES	C FACE KITS
1/4	1800	208-230/460	48	K151	5K32GN30	✓	----	\$221	F1	62.9	1.3-1.4/0.7	14	9.92	20	N/A
	1800	230/460	48	K194	5K33KN92	✓	----	\$322	F1	67.5	1.2/0.6	15	9.19	17,N	N/A
	1800	208-230/460	56	K439	5K49DN4131	✓	----	\$283	F1	67.4	1.1-1.2/0.6	16	9.57	17,N	A536
	1800	575	48	K418	5K32GN53	✓	----	\$299	F1	61.2	0.6	16	9.92	17	N/A
	1200	230/460	56	K321	5K35MN75	✓	----	\$317	F1	66.0	1.4/0.7	17	10.93	20,68	AG215
1/3	3600	208-230/460	48	K153	5K33FN30	✓	----	\$221	F1	61.0	1.5-1.8/0.9	16	10.20	17	N/A
	1800	208-230/460	56	K154	5K49FN4136	✓	----	\$239	F1	69.2	1.5-1.6/0.8	20	10.73	20,68	A536
	1800	208-230/460	56	K196	5K49FN4129	✓	----	\$361	F1	73.4	1.3-1.4/0.7	18	9.57	17,N	A536
	1800	575	56	G304	056T17F2043	✓	----	\$239	F1	65.5	0.6	25	10.22	25	N/A
	1200	230/460	56	K155	5K36PN30	✓	----	\$336	F1	67.3	1.8/0.9	20	11.40	20,68	AG215
1/2	3600	208-230/460	56	G308	056T34F5328	✓	2:1	\$217	F1	66.0	2.1-2.2/1.1	22	11.82	68	A437
	3600	575	56	G309	056T34F5333	✓	2:1	\$217	F1	66.0	0.9	22	11.82		A437
	1800	208-230/460	56	K158	5K35MNB117	✓	----	\$267	F1	76.1	2.1-2.2/1.1	17	10.93	19	AG215
	1800	208-230/460	56	K197	5K42HN4109	✓	----	\$402	F1	76.9	1.8-1.8/0.9	20	9.95	17,N	A536
	1800	575	56	K426	5K42HN4134	✓	----	\$267	F1	76.9	0.8	22	11.00	19,50	A536
	1200	208-230/460	56	K159	5K49MN6079	✓	----	\$369	F1	72.0	2.6-2.6/1.3	27	11.43	5,19	A536
3/4	3600	208-230/460	56	K160	5K37NN30	✓	----	\$259	F1	74.1	2.6-2.5/1.3	18	11.76	19	AG215
	3600	575	56	G327	056T34F5334	✓	2:1	\$259	F1	74.0	1.3	23	11.82		A437
	1800	200-208	56	G328	056T17F2045	✓	----	\$295	F1	75.5	3.2/3.3	21	11.22	25	N/A
	1800	208-230/460	56	K161	5K36PNB111	✓	----	\$295	F1	78.9	2.8-2.8/1.4	20	11.36	19	AG215
	1800	208-230/460	56	K198	5K49PN4113	✓	----	\$414	F1	80.6	2.4-2.4/1.2	31	11.38	17,N	A536
	1800	575	56	G1340	5K36PN251	✓	----	\$295	F1	73.4	1.3	20	11.40	19	AG215
	1200	208-230/460	56	K162	5K46PN6082	✓	----	\$382	F1	76.1	2.9-2.8/1.4	31	11.83	68	AG215
	1200	208-230/460	143T	H700	143TTFR5376	✓	2:1	\$371	E6	74.0	3.2-3.2/1.6	28	12.37	68	A438
1	3600	208-230/460	56	K163	5K38RN30	✓	----	\$291	F1	78.5	3.2-3.0/1.5	25	12.36	19,68	AG215
	3600	575	56	G345	056T34F5335	✓	2:1	\$291	F1	74.0	1.5	24	11.82		A437
	1800	200	143T	E824	143TTFR4028	✓	10:1	\$347	E8	82.5	3.5	32	12.87		A438
	1800	208-230/460	56	G347	056T17F5302	✓	2:1	\$309	F1	77.0	3.5-3.6/1.8	25	12.32	68	A437
	1800	208-230/460	56	K164	5K49MN4105	✓	----	\$394	F1	79.2	3.6-3.8/1.9	27	11.43	17	A536
	1800	575	56	K424	5K49MN4111	✓	----	\$309	F1	78.2	1.7	27	11.43	19	A536
	1200	230/460	56H	K165	5K49UN6085	✓	----	\$408	F1	76.1	3.6/1.8	37	13.07	18,68	A536

Catalog numbers (Cat No.) highlighted in bold blue have efficiency levels that meet EISA requirements

* Requires nameplate modification

Continued on next page.

General Purpose, Three Phase

Totally Enclosed

Rigid Base

HP	RPM	VOLTS	FRAME	CAT. NO.	MODEL NO.	STOCK	CT SPEED RANGE*	LIST PRICE	MULT. SYMB.	NOM. EFF.	F.L. AMPS	WEIGHT	"C" DIM.	FOOT NOTES	C FACE KITS
1 1/2	3600	200	143T	E830	143TTFR4003		2:1	\$366	E8	82.5	4.6	34	12.87		A438
	3600	208-230/460	56	K166	5K46KN2175		-----	\$351	F1	77.3	5.0-4.8/2.4	24	11.83		A536
	3600	575	56	G363	056T34F5336		2:1	\$351	F1	80.0	1.8	25	11.82		A437
	1800	200	145T	E836	145TTFR4029	✓	10:1	\$387	E8	84.0	5.1	44	14.37		A438
	1800	208-230/460	56H	K167	5K49SN4118	✓	-----	\$353	F1	81.7	4.7-4.4/2.2	35	13.07	5,19,68	A536
	1800	575	145T	E838	145TTFR4038		10:1	\$387	E8	84.0	1.8	44	14.37		A438
2	3600	200	145T	E840	145TTFR4005		2:1	\$424	E8	84.0	6.0	38	13.37		A438
	3600	575	56H	G368	056T34F5337		2:1	\$408	F1	80.0	2.4	29	12.32	5	A437
	3600	575	145T	E843	145TTFR4007		2:1	\$424	E8	84.0	2.1	38	13.37		A438
	1800	200	145T	E845	145TTFR4032	✓	10:1	\$424	E8	84.0	64.5	46	13.87		A438
	1800	208-230/460	56	K1492	5K49ZN4252	✓	-----	\$393	F1	83.6	6.2-5.8/2.9	44	14.38		A536
	1800	575	145T	E847	145TTFR4039		10:1	\$424	E8	84.0	2.3	41	13.87		A438
3	3600	208-230/460	56H	G385	056T34F5338		2:1	\$458	F1	84.0	8.4-7.6/3.8	39	13.52	5,68	A437
	3600	575	182T	U603	182TTFR4005		2:1	\$480	E8	85.5	3.0	67	14.97		A644
	1800	200	182T	U605A	182TTFW4327	✓	10:1	\$454	E8	87.5	9.7	61	12.96	13	A666
	1800	230/460	56H	G387	056T17F5327		2:1	\$418	F1	84.0	8.6/4.3	48	14.82	68	A437
	1800	575	182T	U1608	182TTFW4040	✓	10:1	\$454	E8	87.5	3.4	61	12.96	13	A666
	5	3600	200	184T	U611	184TTFR4003		2:1	\$593	E8	87.5	14.3	86	15.97	
3600		575	184T	U614	184TTFR4005		2:1	\$593	E8	87.5	5.0	78	15.97		A644
1800		200	184T	U616	184TTFR4038	✓	10:1	\$530	E8	87.5	15.0	82	15.97		A644
1800		200	184T	U616A	184TTFW4727	✓	10:1	\$530	E8	87.5	15.0	71	13.96	13	A666
1800		200	184T	H1668	184TTFW7727	✓	2:1	\$484	E6	87.5	15.0	82	13.96	13	A666
1800		575	184T	U1619	184TTFW4040		10:1	\$530	E8	87.5	5.3	70	13.96	13	A666
7 1/2	3600	200	213T	U622	213TTFW4003		2:1	\$775	E8	89.5	21.2	136	20.23		A609
	3600	575	213T	U625	213TTFW4005		2:1	\$775	E8	88.5	7.4	128	18.73		A609
	1800	200	213T	U627	213TTFW4028	✓	10:1	\$760	E8	89.5	23.0	125	18.73		A609
	1800	575	213T	U630	213TTFW4030		10:1	\$760	E8	89.5	8.0	135	18.73		A609
	10	3600	200	215T	U634	215TTFW4003		2:1	\$905	E8	89.5	27.6	152	20.23	
3600		575	215T	E821	215TTFW4005		2:1	\$905	E8	89.5	9.6	145	20.23		A609
1800		200	215T	E822	215TTFW4028	✓	10:1	\$920	E8	89.5	29.9	125	20.23		A609
1800		575	215T	U640	215TTFW4030		10:1	\$920	E8	89.5	10.4	138	20.23		A609
15		3600	200	254T	U643	254TTFL14004		2:1	\$1,256	E8	90.2	40.5	178	22.49	AL
	3600	575	254T	U645	254TTFL14005		2:1	\$1,256	E8	90.2	14.0	178	22.99	AL	A1209
	1800	200	254T	U646A	254TTFL4027	✓	10:1	\$1,248	E8	91.0	46.0	178	22.99	AL	A1209
20	1800	200	256T	U651	256TTFL14027		10:1	\$1,536	E8	91.0	58.5	247	26.24	AL	A1209
	1800	575	256T	E998	256TTFL14030		10:1	\$1,536	E8	91.0	20.4	286	26.24	AL	A1209

Catalog numbers (Cat No.) highlighted in bold blue have efficiency levels that meet EISA requirements

* Requires nameplate modification

Blue Chip® General Purpose, Three Phase Totally Enclosed

Applications:

General Purpose use on pumps, fans, blowers, compressors, conveyors, and other industrial machinery installed in damp, dusty, or dirty environments. Additionally, cast iron frame motors may be suitable for the process industries..

Features:

- Frame constructions are heavy gauge steel or Aluminum, as noted
- 1.15 Service Factor
- Nameplated 60/50 hertz at next lowest horsepower
- Will accept C-Face Kits as noted, also see Accessories section
- Severe duty kits available, see Accessories section
- Shaft slinger, regreasable bearings (182T and larger), lead lugs (364T and larger), and bearing caps on 444T and larger
- Ball Bearings, except where noted
- UL Recognized and CSA Certified
- Two year warranty on EISA efficient motors (bold blue Catalog Numbers)



Rigid Base

Suitable for use on VFD per guidelines on page 17.

HP	RPM	VOLTS	FRAME	CAT. NO.	MODEL NO.	STOCK	CT SPEED RANGE*	LIST PRICE	MULT. SYMB.	NOM. EFF.	F.L. AMPS	WEIGHT	"C" DIM.	FOOT NOTES	C FACE KITS		
3/4	1200	208-230/460	143T	H457	143TTFN8076	✓	2:1	\$371	E6	74.0	3.1-3.2/1.6	46	12.04	68	A603		
	1	1800	200	143T	E825	143TTTN4028		1000:1	\$366	E1	82.5	3.7	50	10.43	N	A603	
		1800	208-230/460	143T	E826	143TTTC4026	✓	1000:1	\$366	E1	85.5	3.2-3.0/1.5	51	10.43	N,68	A603	
	1800	575	143T	E828	143TTTN4030		1000:1	\$366	E1	82.5	1.3		50	10.43	N	A603	
	1200	230/460	145T	E829	145TTTN4076	✓	1000:1	\$467	E1	80.0	3.4/1.7		58	11.43	N,68	A655	
	1200	575	145T	U672	145TTTN4080	✓	1000:1	\$467	E1	80.0	1.3		57	11.43	N	A655	
	900	230/460	182T	L409A	182TTFN4101	✓	----	\$760	E8	74.0	4.4/2.2		92	15.87	68	A641	
1 1/2	3600	200	143T	E831	143TTTN4003		1000:1	\$386	E1	86.5	4.6		60	10.43	N	A603	
	3600	208-230/460	143T	E833	143TTTN4001	✓	1000:1	\$386	E1	82.5	4.4-4.0/2.0		51	10.43	N,68	A603	
	3600	575	143T	E835	143TTTN4005		1000:1	\$386	E1	86.5	1.6		42	10.43	N	A603	
	1800	200	145T	U601	145TTTN4032		1000:1	\$406	E1	84.0	5.1		62	11.43	N	A655	
	1800	208-230/460	145T	E837	145TTTC4026	✓	1000:1	\$406	E1	84.0	4.6-4.2/2.1		58	11.43	N,68	A655	
	1800	575	145T	E839	145TTTN4035	✓	1000:1	\$406	E1	84.0	1.8		62	11.43	N	A655	
	900	230/460	184T	L410A	184TTFS14101	✓	----	\$876	E8	78.5	6.1/3.05		99	15.81	68	A644	
	900	230/460	184T	L410B	184TTFN4102	✓	----	\$876	E8	77.0	6.1/3.05		128	15.87	68	A641	
	2	3600	200	145T	E841	145TTTN4003		1000:1	\$447	E1	86.5	6.0		70	11.43	N	A655
		3600	208-230/460	145T	E842	145TTTN4001	✓	1000:1	\$447	E1	84.0	5.8-5.4/2.7		66	11.43	N,68	A655
3600		575	145T	E844	145TTTN4005		1000:1	\$447	E1	86.5	2.1		66	11.43	N	A655	
1800		200	145T	U606	145TTTN4030		1000:1	\$447	E1	85.5	6.9		64	11.43	N	A655	
1800		208-230/460	145T	E846	145TTTC4027	✓	1000:1	\$447	E1	84.0	6.0-5.6/2.8		60	11.43	N,68	A655	
1800		575	145T	E848	145TTTN4040	✓	1000:1	\$447	E1	85.5	2.4		64	11.43	N	A655	
900		230/460	213T	L411A	213TTFN4103	✓	----	\$1,231	E8	82.5	7.5/3.75		189	18.22	68	A646	
900		230/460	213T	L411B	213TTFN4104	✓	----	\$1,231	E8	82.5	7.5/3.75		189	18.22	68	A646	
3	3600	575	182T	U604	182TTFS4005		2:1	\$503	E1	85.5	3.0		81	14.81		A644	
	900	230/460	215T	L421A	215TTFS14103	✓	----	\$1,603	E8	84.0	10.6/5.3		167	19.72	68	A206	
	5	3600	575	184T	U615	184TTFS4005		2:1	\$622	E1	87.5	4.9		106	15.81		A644
1800		575	184T	U620	184TTFS4030		10:1	\$556	E1	87.5	5.2		102	15.81		A644	
900		230/460	254T	L412A	254TTFNA14103	✓	----	\$2,213	E8	87.5	15.0/7.5		534	23.52	68	A239	
7 1/2	3600	575	213T	U671	213TTFS4005		2:1	\$815	E1	88.5	7.6		191	18.2		A206	
	1800	575	213T	U631	213TTFS4030		10:1	\$797	E1	89.5	8.0		174	18.2		A206	
	900	230/460	256T	L413A	256TTFNA14101	✓	----	\$2,816	E8	86.5	23.0/11.5		312	25.27	68	A239	
10	3600	575	215T	U637	215TTFS4005		2:1	\$950	E1	90.2	9.6		184	19.70		A206	
	1800	575	215T	U641	215TTFS4030		10:1	\$966	E1	89.5	10.0		222	19.70		A206	
	900	230/460	284T	L414A	248TTFNA14102	✓	----	\$3,337	E8	84.0	31.0/15.5		388	26.26	68	A239	
15	3600	575	254T	U638	254TTFPA4005		2:1	\$1,319	E1	90.2	14.4		260	23.69		A239	
	1800	575	254T	U648	254TTFNA4030		10:1	\$1,311	E1	91.0	15.6		308	23.52		A284	
	900	230/460	286T	L415A	286TTFNA14106	✓	----	\$4,385	E8	86.5	45.0/22.5		421	28.97	68	A617	

GENERAL PURPOSE THREE PHASE

Catalog numbers (Cat No.) highlighted in bold blue have efficiency levels that meet EISA requirements

Blue shaded areas are Cast Iron Frames

* Requires nameplate modification
Continued on next page.

General Purpose, Three Phase

Totally Enclosed

Rigid Base

Suitable for use on VFD per guidelines on page 17.

HP	RPM	VOLTS	FRAME	CAT. NO.	MODEL NO.	STOCK	CT SPEED RANGE*	LIST PRICE	MULT. SYMB.	NOM. EFF.	F.L. AMPS	WEIGHT	"C" DIM.	FOOT NOTES	C FACE KITS	
20	3600	575	256T	U650	256TTFNA4005		2:1	\$1,732	E1	90.2	18.8	310	25.27		A284	
	1800	575	256T	U653	256TTFNA4030		10:1	\$1,613	E1	91.0	20.0	331	25.27		A284	
	900	230/460	324T	L416A	324TTFS14101	✓	---	\$5,284	E8	87.5	64.0/32.0	512	28.97	68	A214	
25	3600	575	284TS	U654	284TSTFPA4005		2:1	\$2,092	E1	91.0	24.0	545	24.89		A617	
	1800	575	284T	E800	284TTFPA4030		10:1	\$1,901	E1	92.4	24.8	324	26.27		A617	
	1800	200	284T	U655	284TTFPA4028		10:1	\$1,901	E1	92.4	71.0	374	31.87		A617	
	900	230/460	326T	L417A	326TTFS14101	✓	---	\$6,258	E8	88.5	78.0/39.0	625	30.32	68	A214	
30	3600	575	286TS	E819	286TSTFPA4005		2:1	\$2,306	E1	91.0	28.8	406	26.30		A617	
	1800	575	286T	E817	286TTFPA4030		10:1	\$2,308	E1	92.4	29.6	406	27.76		A617	
	900	460	364T	L420	364TTFS8101	✓	---	\$6,526	E6	91.0	41.0	886	31.50	68,89	A395	
40	1800	575	324T	E815	324TTFPA4030		2:1	\$2,985	E1	93.0	40.0	555	28.97		A619	
	900	460	365T	L425	365TTFS8115	✓	---	\$8,085	E6	91.0	53.5	970	32.50	68,89	A395	
50	1800	575	326T	U659	326TTFPA4030		2:1	\$3,843	E1	93.0	49.0	589	30.47		A619	
	900	460	404T	L426	404TTFS8102	✓	---	\$9,632	E6	92.4	69.0	1191	35.62	68,89	A223	
60	1800	575	364T	U660	364TTFS4040		2:1	\$5,639	E1	93.6	57.5	952	31.50		A395	
	900	460	405T	L427	405TTFS8114	✓	---	\$11,169	E6	91.7	81.0	1340	37.12	68,89	A223	
75	1800	575	365T	E805	365TTFS4040		2:1	\$7,207	E1	94.1	71.0	1053	32.50		A395	
	900	460	444T	L428	444TTFS8106	✓	---	\$14,875	E6	93.0	97.0	1820	41.25	68,89	A229	
100	900	460	445T	L429	445TTFN8115	✓	---	\$18,794	E6	93.6	133	2377	43.19	68	A620	
125	900	460	445T	L440	445TTFN8102		---	\$21,852	E6	93.6	169	2377	43.19	H,RB,68	N/A	
150	900	460	447/9	L442	449TTFS8111		---	\$24,652	E6	94.5	206	2872	51.69	H,RB,68	N/A	
200	900	460	L447/9T	L449	449TTFS8110	✓	---	\$25,074	E6	94.5	270	3225	51.69	H,RB,YD,68	N/A	
250	3600	460	447/9TS	L451A	449TSTFS14007	✓	---	\$26,869	E9	95.4	275	2079	48.11	H,YD,68	A624	
	1800	460	445T	L452	445TTFN8040	✓	---	\$18,916	E9	95.0	285	2395	43.19	H,RB,YD,68	N/A	
	1800	460	447/9T	L455	449TTFS8028		---	\$20,335	E9	95.0	290	2802	51.69	H,YD,68	A623	
	1800	460	447/9T	L454	449TTFS8038	✓	---	\$20,335	E9	95.0	290	2775	51.69	H,RB,YD,68	N/A	
	1800	575	445T	L453	445TTFN8041		---	\$18,916	E9	95.0	228	2394	43.19	RB	N/A	
	1200	460	447/9T	L456	449TTFS8087	✓	---	\$21,131	E9	95.4	300	2895	51.69	H,RB,YD,68	N/A	
	1200	460	447/9T	L457	449TTFS8077		---	\$21,131	E9	95.4	300	3092	51.69	H,YD,68	A623	
	900	460	L447/9T	L471	449TTFS18105		---	\$23,108	E6	94.5	330	3586	56.71	H,RB,YD,17	N/A	
	300	3600	460	447/9TS	L459	449TSTFS8002	✓	---	\$28,760	E9	95.4	330	2633	47.88	H,YD,68	A624
		1800	460	447/9T	L462	449TTFS8037	✓	---	\$21,396	E9	95.4	338	2717	51.69	H,RB,YD,68	N/A
1800		575	447/9T	L472A	---		---	\$22,872	E9	95.4	330	2900	51.86	H,RB,YD	A623	
1800		460	447/9T	L463	449TTFS8027	✓	---	\$22,872	E9	95.4	338	3041	51.69	H,YD,68	A623	
1200		460	L447/9T	L465	449TTFS8076		---	\$24,543	E9	95.4	360	3440	51.69	H,YD,17,68	A623	
1200		460	447/9T	L464	449TTFS8086	✓	---	\$24,543	E9	95.4	360	3428	51.69	H,RB,YD,17,68	N/A	
350	3600	460	447/9TS	L466	449TSTFS8001	✓	---	\$33,035	E9	95.4	380	2931	47.88	H,YD,68	A624	
	1800	460	L447/9T	L467	449TTFS8036	✓	---	\$24,420	E9	95.4	400	3042	51.69	H,RB,YD	N/A	
400	1800	460	447/9T	L469A	449TTFS14043	✓	---	\$27,882	E9	95.4	469	3088	51.86	H,RB,17	N/A	

Catalog numbers (Cat No.) highlighted in bold blue have efficiency levels that meet EISA requirements

Blue shaded areas are Cast Iron Frames

* Requires nameplate modification

General Purpose, Three Phase

Totally Enclosed

Applications:

General purpose use on gear reducers, pumps, machine tools, and other direct-coupled equipment installed in damp, dusty, or dirty environments. Additionally, cast iron frame motors may be suitable for the process industries.

Features:

- Ball bearings, mechanically locked on shaft end (excludes 5K models)
- Rated 60/50 hertz, 190/380 or 380 volt, at next lower horsepower (as noted)
- 1.15 Service Factor (except as noted)
- Rolled steel 56-145T frame motors accept brake kits, see Accessories section (except as noted)
- UL Recognized and CSA Certified



C-Face Footless

Suitable for use on VFD per guidelines on page 17.

HP	RPM	VOLTS	FRAME	CAT. NO.	MODEL NO.	STOCK	CT SPEED RANGE*	LIST PRICE	MULT. SYMB.	NOM. EFF.	F.L. AMPS	WEIGHT	"C" DIM.	FOOT NOTES
1/4	1800	208-230/460	56C	K252	5K49DN4130	✓	----	\$237	F1	67.4	1.1-1.2/0.6	16	9.52	N,20,24,68
	1800	575	56C	K405	056T17F2047		----	\$237	F1	62.0	0.5	13	9.94	24
1/3	3600	208-230/460	56C	P101	056T34T5306	✓	2:1	\$205	F1	64.0	1.7-2.0/1.0	18	9.94	N,68
	1800	208-230/460	56C	K253	5K33JNA943	✓	----	\$253	F1	68.8	1.5-1.6/0.8	16	10.60	24,68,111
1/2	1800	575	56C	K522	5K33KN67	✓	----	\$253	F1	71.1	0.6	16	10.60	20,24,68
	3600	208-230/460	56C	P102	056T34F5321	✓	2:1	\$228	F1	66.0	2.1-2.2/1.1	21	11.82	68
1/2	1800	208-230/460	56C	K254	5K35MNB114	✓	----	\$295	F1	76.1	2.1-2.2/1.1	17	10.93	19,24
	1800	575	56C	K469	5K42HN4137	✓	----	\$295	F1	80.0	0.8	22	11.01	19,24,68
1/2	1200	208-230/460	56C	K1316	5K49MN6020	✓	----	\$464	F1	72.0	2.6-2.6/1.3	27	11.44	19,24
	3600	208-230/460	56C	P103	056T34F5322	✓	2:1	\$270	F1	72.0	3.0-3.2/1.6	22	11.82	68
3/4	1800	208-230/460	56C	K255	5K36PNB116	✓	----	\$325	F1	78.9	2.8-2.8/1.4	20	11.36	19,24,68
	1800	575	56C	K523	5K36PN254	✓	----	\$325	F1	73.4	1.3	20	11.36	19,24,68
1	1200	208-230/460	143TC	K1318	5K49PN8030	✓	----	\$480	E6	76.1	2.9-2.8/1.4	31	12.56	24
	1200	208-230/460	56C	K1317	5K49PN6025	✓	----	\$472	F1	76.1	2.9-2.9/1.4	31	12.44	24
1	1200	208-230/460	56C	K404	056T11F5320		2:1	\$392	F1	74.0	3.1-3.2/1.6	26	12.32	68
	3000	208-220/440	56C	K633	5K36MN4152	✓	----	\$400	F1	77.0	3.6-3.6/1.8	20	11.36	17,24,68
1	3600	208-230/460	56C	P104	056T34F5323	✓	2:1	\$303	F1	74.0	3.7-3.7/1.85	24	11.82	68
	1800	208-230/460	56C	K256	5K49MN4104	✓	----	\$332	F1	79.2	3.6-3.8/1.9	27	11.44	19,24,68
1	1800	208-230/460	143TC	C220A	143TTFR4329	✓	2:1	\$375	E8	82.5	3.2-3.0/1.5	35	12.87	68
	1800	575	56C	K524	5K49MN4112	✓	----	\$332	F1	78.2	1.7	27	11.44	19,24
1	1800	575	143TC	C230	143TTFR5333		2:1	\$348	E6	77.0	1.5	26	12.37	
	1800	575	143TC	C230A	143TTFR4333		2:1	\$375	E8	82.5	1.2	32	12.37	
1	1200	208-230/460	145TC	C250A	145TTFR4378	✓	2:1	\$469	E8	80.0	3.6-3.4/1.7	39	13.37	68
	1200	208-230/460	56C	K1490	5K49PN6164	✓	----	\$483	F1	74.2	3.9-3.8/1.9	31	12.44	24
1	1200	208-230/460	56C	K407	056T11F5321		2:1	\$419	F1	77.0	3.8-3.6/1.8	33	12.82	68
	3600	208-230/460	56C	P105	056T34F5324	✓	2:1	\$352	F1	80.0	4.6/2.3	25	11.82	68
1 1/2	3600	208-230/460	56C	KG235	5K49PN2348	✓	----	\$434	F1	81.7	4.8-4.2/2.1	31	12.44	24,68,111
	3600	208-230/460	143TC	C201	143TTFR5302	✓	2:1	\$360	E6	80.0	4.7-4.6/2.3	35	11.87	d,68
1 1/2	3600	208-230/460	143TC	C201A	143TTFR4302	✓	2:1	\$388	E8	82.5	4.4-4.0/2.0	41	11.87	68
	1800	208-230/460	56C	K257	5K49SN4117	✓	----	\$365	F1	81.7	4.7-4.4/2.2	35	12.44	19,24,68
1 1/2	1800	208-230/460	145TC	C221A	145TTFR4332	✓	2:1	\$436	E8	84.0	4.6-4.4/2.2	38	14.37	68
	1800	575	56C	G548	056T17F5320		2:1	\$365	F1	80.0	1.9	31	12.32	
1 1/2	1800	575	145TC	C231	145TTFR5340		2:1	\$405	E6	80.0	1.9	29	12.37	
	1800	575	145TC	C231A	145TTFR4340		2:1	\$436	E8	84.0	1.8	38	14.37	
1 1/2	1200	230/460	182TC	C251A	---		2:1	\$845	E8	75.5	5.0/2.5	89	17.93	F,68
	3600	208-230/460	56C	P106	056T34F5325	✓	2:1	\$408	F1	80.0	6.0-6.0/3.0	29	12.32	68
2	3600	208-230/460	56C	KG237	5K49SN2187	✓	----	\$497	F1	83.0	5.8-5.4/2.7	35	12.97	24,68,110
	3600	208-230/460	145TC	C202A	145TTFR4306	✓	2:1	\$451	E8	84.0	5.6-5.2/2.6	38	13.37	68
2	1800	208-230/460	56C	K1491	5K49ZN4253	✓	----	\$393	F1	83.6	6.2-5.8/2.9	45	14.25	24,68
	1800	208-230/460	145TC	K2033	5KE48WN8365	✓	----	\$533	E6	84.0	6-5.6/2.8	43	13.84	24,68
2	1800	575	56C	G549	056T17F5329		2:1	\$393	F1	82.5	2.3	41	13.82	
	1800	575	145TC	C232	145TTFR5341		2:1	\$433	E6	82.5	2.3	41	13.87	
2	1800	575	145TC	C232A	145TTFR14048		2:1	\$466	E8	84.0	2.3	49	14.87	
	1200	230/460	184TC	C252A	---		2:1	\$947	E8	80.0	6.7/3.35	89	15.69	F,24,68

Catalog numbers (Cat No.) highlighted in bold blue have efficiency levels that meet EISA requirements

* Requires nameplate modification

Continued on next page.

General Purpose, Three Phase

Totally Enclosed

C-Face Footless

HP	RPM	VOLTS	FRAME	CAT. NO.	MODEL NO.	STOCK	CT SPEED RANGE*	LIST PRICE	MULT. SYMB.	NOM. EFF.	F.L. AMPS	WEIGHT	"C" DIM.	FOOT NOTES
3	3600	208-230/460	56C	P107	056T34F5326	✓	2:1	\$443	F1	84.0	8.4-7.6/3.8	38	13.32	68
	3600	208-230/460	145TC	C236A	145TTFR4307	✓	2:1	\$451	E8	85.8	8.4-7.6/3.8	39	13.37	68
	3600	208-230/460	182TC	C203B	182TTFW14004	✓	2:1	\$575	E8	85.5	8.2-7.4/3.7	65	13.97	F,13,24,68
	1800	208-230/460	182TC	C223B	182TTFW4027	✓	2:1	\$552	E8	87.5	8.8-8.4/4.2	64	12.97	13,68
	1800	230/460	56C	K640	5K49QN4609	✓	-----	\$484	F1	84.7	8.2/4.1	54	14.89	17,24,68
	1200	230/460	213TC	C253A	213TTFW14081		2:1	\$787	E8	81.5	9.6/4.8	108	19.46	F,24,68
5	3600	208-230/460	184TC	C204B	184TTFW14004	✓	2:1	\$660	E8	87.5	13.4-12.2/6.1	74	14.47	13,68
	1800	208-230/460	184TC	C1224	184TTFW8641	✓	2:1	\$576	E8	87.5	16-14.8/7.4	70	13.97	13,68
	1200	208-230/460	215TC	C254A	215TTFW14084		2:1	\$1,096	E8	87.5	16.0-14.8/7.4	179	20.96	24,68
7 1/2	3600	208-230/460	184TC	C238B	184TTFW14021	✓	2:1	\$791	E8	88.5	18.5-16.8/8.4	95	15.97	13,68
	3600	208-230/460	213TC	C205A	213TTFW14011	✓	2:1	\$873	E8	88.5	21.0-19.2/9.6	84	19.46	F,24,68
	1800	208-230/460	213TC	C225A	213TTFW14045	✓	2:1	\$766	E8	89.5	22.0-19.4/9.7	110	19.46	F,24,68
	1200	230/460	254TC	C255A	254TTFW14078		-----	\$1,481	E8	89.5	22.0/11.0	148	23.24	AL,F,24,68
	10	3600	208-230/460	215TC	C206A	215TTFW14024	✓	2:1	\$1,044	E8	89.5	27.0-24.0/12.0	142	20.96
10	1800	208-230/460	215TC	C226A	215TTFW14041	✓	2:1	\$1,006	E8	89.5	28.0-26.0/13.0	138	20.96	F,24,68
	1200	230/460	256TC	C256A	256TTFNA14086		-----	\$1,831	E8	89.5	26.0/13.0	375	25.94	F,24,68
	15	3600	208-230/460	215TC	C237A	215TTFW14022	✓	2:1	\$1,327	E8	90.2	39.0-36.0/18.0	154	20.96
15	3600	230/460	254TC	C207A	254TTFW14009		-----	\$1,443	E8	90.2	35.0/17.5	210	23.24	AL,F,24,68
	1800	208-230/460	254TC	C227A	254TTFW14037	✓	-----	\$1,429	E8	91.0	42.0-40.0/20.0	199	23.24	AL,F,24,68

Catalog numbers (Cat No.) highlighted in bold blue have efficiency levels that meet EISA requirements

Blue shaded areas are Cast Iron Frames

* Requires nameplate modification

General Purpose, Three Phase

Totally Enclosed (Four in One)

Features:

- Ball bearings, mechanically locked on shaft end (excludes 5K models)
- 1.15 Service Factor (except as noted)
- Class F insulation (except as noted)
- Rated 60/50 hertz, 190/380 or 380 volt, at next lower horsepower (as noted)
56-145T frame motors, accept brake kits, see accessory kits
- UL Recognized and CSA Certified
- Two year warranty on EAct (bold blue catalog numbers)
- Three year warranty on NEMA Premium efficient (bold blue catalog numbers)



Additional features for "Four-In-One" motors only:

- CR200 Corona resistant magnet wire
- Bolt-on, removable rigid base
- Suitable for horizontal and vertical mounting
- Will accept drip cover kits, see Accessories section



C-Face Footed (Rigid and Removable Base)

Suitable for use on VFD per guidelines on page 17.

HP	RPM	VOLTS	FRAME	"FOUR IN-ONE"	CAT. NO.	MODEL NO.	STOCK	CT SPEED RANGE*	LIST PRICE	MULT. SYMB.	NOM. EFF.	F.L. AMPS	WEIGHT	"C" DIM.	FOOT NOTES	
1/4	1800	208-230/460	56C		G565	056T117F2051		2:1	\$242	F1	62.5	1.2-1.4/0.7	14	9.94	BI,24,68	
	1200	208-230/460	56C	YES	G586	056T11F5311	✓	2:1	\$343	F2	52.5	1.7-2.0/1.0	19	11.31	6,13,68	
1/3	3600	208-230/460	56C	YES	D390	056T34T5303	✓	1000:1	\$217	F2	66.0	1.7-1.8/0.9	20	10.43	N,6,13,24,68	
	3600	575	56C	YES	K702	056T34T5309		1000:1	\$217	F2	64.0	0.8	19	9.93	N,6,13,24	
	1800	208-230/460	56C		K1322	5K42FN4035	✓	---	\$270	F1	69.2	1.5-1.6/0.8	20	11.01	20,24,68	
	1800	208-230/460	56C	YES	G580	056T17T5305	✓	1000:1	\$278	F2	68.0	1.4-1.6/0.8	20	9.93	N,6,13,24,68	
	1800	575	56C	YES	K703	056T17T5316	✓	1000:1	\$278	F2	68.0	0.7	20	9.93	N,6,13,24	
	1200	208-230/460	56C	YES	G587	056T11F5310	✓	10:1	\$361	F2	62.0	1.9-2.2/1.1	21	11.31	6,13,68	
1/2	3600	208-230/460	56C		G569	056T34F5308		2:1	\$233	F1	66.0	2.1-2.2/1.1	23	11.82	BI,13,68	
	3600	208-230/460	56C	YES	D391	056T34F5301	✓	10:1	\$242	F2	66.0	2.1-2.2/1.1	22	11.81	6,13,68	
	3600	575	56C	YES	K704	056T34F5348	✓	10:1	\$242	F2	66.0	0.9	22	11.81	6,13	
	1800	208-230/460	56C		K1324	5K42HN4034	✓	---	\$299	F1	74.7	2.3-2.2/1.1	22	11.01	19,24,68	
	1800	208-230/460	56C	YES	G581	056T17F5321	✓	10:1	\$308	F2	68.0	2.3-2.4/1.2	24	11.81	6,13,68	
	1800	575	56C	YES	K705	056T17F5336	✓	10:1	\$308	F2	68.0	1.0	23	11.81	6,13	
	1200	208-230/460	56C	YES	G588	056T11F5309	✓	10:1	\$393	F2	68.0	2.4-2.7/1.35	23	11.81	6,13,68	
	3/4	3600	208-230/460	56C	YES	D392	056T34F5302	✓	4:1	\$282	F2	68.0	3.0-3.2/1.6	23	11.81	6,13,68
		3600	575	56C	YES	K706	056T34F5349	✓	4:1	\$282	F2	68.0	1.3	23	11.81	6,13
		1800	208-230/460	56C		K258	5K49KN4124	✓	---	\$330	F1	74.3	3.3-3.0/1.5	24	11.41	19,24,68
		1800	208-230/460	56C	YES	G582	056T17F5322	✓	10:1	\$337	F2	75.5	2.6-3.0/1.5	40	11.81	6,13,68
		1800	575	56C	YES	K707	056T17F5337	✓	10:1	\$337	F2	75.5	1.2	24	11.81	6,13
1200		208-230/460	56C	YES	G589	056T11F5308	✓	4:1	\$405	F2	74.0	3.1-3.2/1.6	27	12.31	6,13,68	
1	3600	208-230/460	56C		K500	5K38RN106	✓	---	\$307	F1	78.5	3.2-3.0/1.5	32	12.4	19,24,68	
	3600	208-230/460	56C	YES	D393	056T34F5303	✓	4:1	\$314	F2	74.0	3.7-3.7/1.85	25	11.81	6,13,68	
	3600	575	56C	YES	K708	056T34F5350	✓	4:1	\$314	F2	77.0	1.5	25	11.81	6,13	
	1800	208-230/460	56C		K259	5K49MN4110	✓	---	\$336	F1	79.2	3.6-3.8/1.9	27	11.41	19,24,68	
	1800	208-230/460	56HC	YES	G583	056T17F5323	✓	10:1	\$344	F2	77.0	3.5-3.6/1.8	26	12.31	5,6,13,68	
	1800	575	56HC	YES	K709	056T17F5338	✓	4:1	\$344	F2	77.0	1.5	27	12.31	5,6,13	
	1200	208-230/460	56HC	YES	K701	056T11F5307	✓	4:1	\$433	F2	77.0	3.95-4.0/2.0	32	12.81	5,6,13,68	

Catalog numbers (Cat No.) highlighted in bold blue have efficiency levels that meet EISA requirements

* Requires nameplate modification

Continued on next page.

General Purpose, Three Phase

Totally Enclosed

C-Face Footed (Rigid and Removable Base)

HP	RPM	VOLTS	FRAME	"FOUR IN-ONE"	CAT. NO.	MODEL NO.	STOCK	CT SPEED RANGE*	LIST PRICE	MULT. SYMB.	NOM. EFF.	F.L. AMPS	WEIGHT	"C" DIM.	FOOT NOTES	
1 1/2	3600	208-230/460	56C	YES	D394	056T34F5304	✓	2:1	\$375	F2	80.0	4.7-4.6/2.3	25	11.81	6,13,68	
	3600	575	56C	YES	K721	056T34F5351	✓	2:1	\$375	F2	80.0	1.8	26	11.81	6,13	
	1800	200	145TC		U703	145TTFR4046		10:1	\$415	E8	84.0	5.1	44	14.37		
	1800	208-230/460	56HC		K260	5K49SN4119	✓	---	\$369	F1	81.7	4.7-4.4/2.2	35	12.44	19,24,50	
	1800	575	145TC		U705	145TTFR4052		10:1	\$415	E8	84.0	1.8	44	14.37	6	
	1800	208-230/460	56HC	YES	G584	056T17F5324	✓	10:1	\$376	F2	80.0	4.8-4.8/2.4	30	12.31	5,6,13,68	
	1800	575	56HC	YES	K722	056T17F5339	✓	2:1	\$376	F2	80.0	1.9	29	12.31	5,6,13	
	1200	230/460	56HC	YES	K700	056T11F5328	✓	2:1	\$460	F2	77.5	5.8/2.9	42	14.32	5,6,13,17	
	2	3600	208-230/460	56HC	YES	D395	056T34F5305	✓	2:1	\$433	F2	80.0	6.0-6.0/3.0	29	12.31	5,6,13,68
		3600	575	56HC	YES	K723	056T34F5352	✓	2:1	\$433	F2	80.0	2.4	30	12.31	5,6,13
1800		200	145TC		U706	145TTFR4070		10:1	\$445	E8	84.0	6.4	42	13.87		
1800		208-230/460	56HC		K806	056T17F5330	✓	2:1	\$410	F1	82.5	6.0-5.8/2.9	40	13.82	Bl,5,6,8	
1800		575	145TC		U708	145TTFR4126		10:1	\$445	E8	84.0	2.2	42	13.87		
1800		208-230/460	56HC	YES	G585	056T17F5325	✓	10:1	\$409	F2	82.5	6.0-5.8/2.9	40	13.81	5,6,13,68	
1800		575	56HC	YES	K724	056T17F5340	✓	4:1	\$409	F2	82.5	2.3	39	13.81	5,6,13	
1200		230/460	184TC	YES	C380B	184TTFW16051	✓	10:1	\$866	E8	88.5	6.4/3.2	74	14.97	6,13,24,68	
3		3600	200	182TC		U736	182TTFR4013		2:1	\$622	E8	85.5	8.5	76	15.69	24,13
		3600	208-230/460	56HC	YES	D396	056T34F5306	✓	2:1	\$481	F2	84.0	8.4-7.6/3.8	40	13.31	5,6,13,68
	3600	575	56HC	YES	K725	056T34F5353	✓	2:1	\$481	F2	84.0	3.1	40	13.31	5,6,13	
	3600	208-230/460	182TC	YES	C381B	182TTFW16021	✓	10:1	\$884	E8	86.5	8.2-7.4/3.7	75	14.47	6,13,24,68	
	1800	230/460	56HCZ	YES	G590	056T17F5355	✓	---	\$460	F2	85.5	8.6/4.3	48	14.87	Z,5,6,13,17,68	
	1800	575	56HCZ	YES	G591	056T17F5356		---	\$460	F2	85.5	3.4	48	14.87	Z,5,6,13,17	
	1800	208-230/460	182TC	YES	C382B	182TTFW16030	✓	10:1	\$790	E8	89.5	8.6-7.8/3.9	75	14.47	6,13,24,68	
	1800	575	182TC	YES	C383A	182TTFW4345		10:1	\$676	E8	87.5	3.4	76	15.50	6,13,24	
	1800	575	182TC	YES	C383B	182TTFW16027	✓	10:1	\$790	E8	89.5	3.2	89	14.97	6,13,24	
	1200	208-230/460	213TC	YES	C384A	213TTFW16078	✓	10:1	\$1,105	E8	89.5	9.2-8.8/4.4	123	20.97	6,24,68	
5	3600	200	184TC		U738	184TTFR4013		2:1	\$731	E8	87.5	14.2	90	16.69	24,13	
	3600	230/460	184TC	YES	C385B	184TTFW16006	✓	10:1	\$944	E8	88.5	13.1-12.0/6.0	94	14.97	13,24,68	
	1800	230/460	184TC	YES	C386B	184TTFW16027	✓	10:1	\$833	E8	89.5	12.6/6.3	85	14.97	13,24,68	
	1800	575	184TC	YES	C387B	184TTFW16029	✓	10:1	\$833	E8	89.5	5.1	72	14.97	6,13,24,68	
	1200	208-230/460	215TC	YES	C388A	215TTFW16079	✓	10:1	\$1,318	E8	90.2	15.0-14.0/7.0	157	22.22	6,13,24,68	

Catalog numbers (Cat No.) highlighted in bold blue have efficiency levels that meet EISA requirements

* Requires nameplate modification

Continued on next page.

General Purpose, Three Phase

Totally Enclosed

C-Face Footed (Rigid and Removable Base)

HP	RPM	VOLTS	FRAME	"FOUR IN-ONE"	CAT. NO.	MODEL NO.	STOCK	CT SPEED RANGE*	LIST PRICE	MULT. SYMB.	NOM. EFF.	F.L. AMPS	WEIGHT	"C" DIM.	FOOT NOTES
7 1/2	3600	200	213TC		U740	213TTFW4007		2:1	\$958	E8	89.5	21.2	118	20.97	24
	3600	575	213TC		U742	213TTFW4008		2:1	\$958	E8	89.5	7.4	118	20.97	24
	3600	208-230/460	213TC	YES	C389A	213TTFW16008	✓	10:1	\$1,225	E8	90.2	19.6-17.8/8.9	125	20.97	6,24,68
	1800	208-230/460	213TC	YES	C390A	213TTFW16035	✓	10:1	\$1,105	E8	91.7	21.0-18.6/9.3	157	22.22	6,24,68
	1800	575	213TC	YES	C391	213TTFW4345		10:1	\$945	E8	89.5	8.0	122	20.97	d,6,24
	1800	575	213TC	YES	C391A	213TTFW16036	✓	10:1	\$1,105	E9	91.7	7.5	157	22.22	6,24
10	3600	200	215TC		U743	215TTFW4013		2:1	\$1,012	E8	89.5	27.6	175	20.97	24
	3600	208-230/460	215TC	YES	C392A	215TTFW16005	✓	10:1	\$1,275	E8	91.7	26.4-23.6/11.8	139	22.22	6,24,68
	1800	200	215TC		U718	215TTFW4033		10:1	\$957	E8	89.5	29.9	128	20.97	24
	1800	208-230/460	215TC	YES	C393A	215TTFW16041	✓	10:1	\$1,215	E8	91.7	28.0-26.0/13.0	189	22.22	6,24,68
	1800	575	215TC	YES	C394	215TTFW4345		10:1	\$1,039	E8	89.5	10.4	191	20.97	6,24
	1800	575	215TC	YES	C394A	215TTFW16042		10:1	\$1,215	E8	91.7	10.3	208	22.22	6,24
15	1800	200	254TC		U721	254TTFW4033		10:1	\$1,436	E8	91.0	46.0	189	23.24	AL,24
	1800	575	254TC		U723	254TTFW4035		10:1	\$1,436	E8	91.0	16.0	236	23.24	AL,24

Catalog numbers (Cat No.) highlighted in bold blue have efficiency levels that meet EISA requirements

Blue shaded areas are Cast Iron Frames

* Requires nameplate modification

Brake Kits for

56-143-145 frames ONLY (as noted)

TORQUE (LB-FT)	COIL VOLTAGE	CAT. NO.	STOCK	LIST (LOOSE)	LIST (INSTALLED)	MULT. SYMB.	WEIGHT
3	208-230/460	A301	✓	\$398	\$563	S4	10
	208-230/460	A1301	✓	\$398	\$563	S4	10
	575	A297	✓	\$398	\$563	S4	10
	575	A1297	✓	\$398	\$563	S4	3
	208-230/460	A302	✓	\$469	\$632	S4	11
6	208-230/460	A1302	✓	\$469	\$632	S4	10
	575	A298	✓	\$469	\$632	S4	11
	575	A1298	✓	\$469	\$632	S4	10
10	208-230/460	A303	✓	\$580	\$737	S4	10
	208-230/460	A1303	✓	\$580	\$737	S4	10
	575	A299	✓	\$580	\$737	S4	10
	575	A1299	✓	\$580	\$737	S4	10

Drip Cover Kits (Four-In-One)

CAT. NO.	STOCK	FRAME	LIST PRICE	MULT. SYMB.	WEIGHT
A234	✓	56-143T-145T	\$24	S4	2
A197	✓	182T-184T	\$27	S4	3
A199	✓	213T-215T	\$31	S4	5

NEMA Premium® XRI® Efficiency

Three Phase, Totally Enclosed

Applications:

General purpose use on compressors, pumps, conveyors, blowers, and other machinery in dirty and dusty environments. Substantial energy savings can be realized when using these high efficiency motors. Guaranteed efficiencies offer an eXtra Return on your Investment when using these premium efficiency motors on high cycle or long run time applications.

Features:

- Meets or exceeds NEMA Premium® efficiencies, except where noted NEMA Premium® models are in compliance with EISA2007
- Suitable for use on a VFD. Variable Torque and Constant Torque (as noted)
- 1.15 Service Factor on sinewave, 1.0 Service Factor on IGBT power
- F1 conduit box on Rigid Base, F3 on C-Face Footed (Rigid Base) motors
- Bearing Current Protection (BCP), as noted
- Shaft slinger
- Class F insulation
- 1.15 Service Factor
- Ball bearings (except as noted)
- C-Face Footed models are rated 60/50 Hz, same HP
- Motors accept C-face kits, as noted
- UL Recognized, CSA Certified and CE Mark
- Three year warranty



Rigid Base



Models through 40 HP are capable of modification as follows (contact factory to confirm):

- 1.25 Service Factor (sinewave only)
- 50Hz at same HP, 1.0 Service Factor (sinewave only)
- Certain combinations of existing and new nameplate markings are not possible (contact factory to confirm)
- Any nameplate changes are subject to modification charges (see MOD Central section)
- Contact Marathon Motors for optional nameplate markings on 50 HP and larger



Rigid Base

Suitable for use on VFD per guidelines on page 17.

HP	RPM	VOLTS	FRAME	CAT. NO.	MODEL NO.	STOCK	CT SPEED RANGE*	LIST PRICE	MULT. SYMB.	NOM. EFF.	F.L. AMPS	WEIGHT	"C" DIM.	FOOT NOTES	C FACE KITS	
1	3600	200	56H	E2150	56T34F16001		10:1	\$540	E9	80.0	3.2	24	11.31		A437	
	3600	230/460	56H	E2100	56T34F15940	✓	10:1	\$540	E9	80.0	2.8/1.4	24	11.31		A642	
	3600	575	56H	E2125	56T34F16020		10:1	\$540	E9	80.0	1.1	24	11.31		A437	
	1800	200	143T	E2151	143TTFR16038	✓	10:1	\$465	E9	85.5	3.7	32	13.75		A642	
	1800	230/460	143T	E2101	143TTFR15642	✓	10:1	\$465	E9	85.5	3.2/1.6	32	13.75		A642	
	1800	230/460	143T	E2201-P	143TTFN16040	✓	10:1	\$682	E9	85.5	3.0/1.5	48	13.99	P	A603	
	1800	575	143T	E2126	143TTFR16040	✓	10:1	\$465	E9	85.5	1.3	32	13.75		A642	
	1200	200	145T	E2152	145TTFR15581		10:1	\$555	E9	82.5	4.4	42	13.43		A642	
	1200	230/460	145T	E2102	145TTFR16078	✓	10:1	\$555	E9	82.5	3.8/1.9	42	13.75		A642	
	1200	575	145T	E2127	145TTFR16080		10:1	\$555	E9	82.5	1.5	42	13.75		A642	
	1 1/2	3600	200	143T	E2153	143TTFR16001		10:1	\$561	E9	84.0	4.6	37	13.75		A642
		3600	230/460	143T	E2103	143TTFR15582	✓	10:1	\$561	E9	84.0	4.0/2.0	37	13.75		A642
3600		575	143T	E2128	143TTFR16020		10:1	\$561	E9	84.0	1.6	37	13.75		A642	
3600		230/460	143T	E351	143TTTN6001		20:1	\$655	E9	86.5	4.0/2.0	54	10.43	N,NE	A603	
1800		200	145T	E2154	145TTFR16038	✓	10:1	\$478	E9	86.5	5.5	34	13.75		A642	
1800		230/460	145T	E2104	145TTFR16033	✓	10:1	\$478	E9	86.5	4.8/2.4	34	13.75		A642	
1800		230/460	145T	E2204-P	145TTFN16046	✓	10:1	\$720	E9	86.5	4.6/2.3	54	13.99	P	A603	
1800		575	145T	E2129	145TTFR16040	✓	10:1	\$478	E9	86.5	1.9	34	13.75		A642	
1200		200	182T	E2155	182TTFW16082		10:1	\$710	E9	87.5	6.0	89	14.47	13	A666	
1200		230/460	182T	E2105	182TTFW16076	✓	10:1	\$710	E9	87.5	5.6/2.8	89	14.97	13	A666	
1200		575	182T	E2130	182TTFW16080		10:1	\$710	E9	87.5	2.2	89	14.47	13	A666	

Catalog numbers (Cat No.) highlighted in bold blue have efficiency levels that meet EISA requirements

Blue shaded areas are Cast Iron Frames

* Requires nameplate modification

Continued on next page.

NEMA Premium® XRI® Efficiency

Three Phase, Totally Enclosed

Rigid Base

HP	RPM	VOLTS	FRAME	CAT. NO.	MODEL NO.	STOCK	CT SPEED RANGE*	LIST PRICE	MULT. SYMB.	NOM. EFF.	F.L. AMPS	WEIGHT	"C" DIM.	FOOT NOTES	C FACE KITS
2	3600	200	145T	E2156	145TTFR16001		10:1	\$578	E9	85.5	5.5	44	13.75		A642
	3600	230/460	145T	E2106	145TTFR13002	✓	10:1	\$578	E9	85.5	4.8/2.4	44	13.75		A642
	3600	575	145T	E2131	145TTFR16020		10:1	\$578	E9	85.5	1.9	44	13.75		A642
	3600	230/460	145T	E353	145TTTN6001		20:1	\$642	E9	85.5	5.0/2.5	64	11.43	N,NE	A603
	1800	200	145T	E2157	145TTFR16038	✓	10:1	\$525	E9	86.5	6.7	50	14.75		A642
	1800	230/460	145T	E2107	145TTFR16035	✓	10:1	\$525	E9	86.5	5.8/2.9	50	14.75		A642
	1800	230/460	145T	E2207-P	145TTFN16045	✓	10:1	\$684	E9	86.5	6.0/3.0	64	13.99	P	A603
	1800	575	145T	E2132	145TTFR16045	✓	10:1	\$525	E9	86.5	2.3	50	14.75		A642
	1200	200	184T	E2158	184TTFW16079		10:1	\$839	E9	88.7	7.4	89	14.97	13	A666
	1200	230/460	184T	E2108	184TTFW16076	✓	10:1	\$839	E9	88.7	6.4/3.2	89	14.97	13	A666
	1200	575	184T	E2133	184TTFW16081		10:1	\$839	E9	88.7	2.6	89	14.97	13	A666
	1200	575	184T	E002	184TTFC6081	✓	10:1	\$899	E9	88.5	3.0	125	16.80	d	N/A
3	3600	200	182T	E2159	182TTFW16002	✓	10:1	\$777	E9	86.5	8.7	66	13.97	13	A666
	3600	230/460	182T	E2109	182TTFW16001	✓	10:1	\$777	E9	86.5	7.6/3.8	66	13.97	13	A666
	3600	575	182T	E2134	182TTFW16020	✓	10:1	\$777	E9	86.5	3.0	66	13.97	13	A666
	3600	230/460	182T	E216	182TTTS6001		20:1	\$882	E9	89.5	7.6/3.8	94	12.71	N,NE	A644
	1800	200	182T	E2160	182TTFW16038	✓	10:1	\$693	E9	89.5	9.0	80	13.97	13	A666
	1800	230/460	182T	E2110	182TTFW16026	✓	10:1	\$693	E9	89.5	7.8/3.9	80	13.97	13	A666
	1800	230/460	182T	E2210-P	182TTFN16047	✓	10:1	\$909	E9	89.5	8.0/4.0	104	15.87	P	A644
	1800	575	182T	E2135	182TTFW16040	✓	10:1	\$693	E9	89.5	3.1	80	13.97	13	A666
	1800	575	182T	U609A	182TTFC6031	✓	10:1	\$747	E9	89.5	3.2	104	15.89	d	N/A
	1800	575	182T	E303	182TTTS6030		1000:1	\$791	E9	90.2	3.2	100	12.71	N,NE	A644
	1200	200	213T	E2161	213TTFW16082		10:1	\$1,026	E9	89.5	10.1	115	18.73		A609
	1200	230/460	213T	E2111	213TTFW16076	✓	10:1	\$1,026	E9	89.5	8.8/4.4	115	18.73		A609
	1200	575	213T	E2136	213TTFW16081		10:1	\$1,026	E9	89.5	3.5	115	18.73		A609
5	3600	200	184T	E2162	184TTFW16002	✓	10:1	\$882	E9	88.5	13.8	96	16.47	13	A666
	3600	230/460	184T	E2112	184TTFW16001	✓	10:1	\$882	E9	88.5	12.0/6.0	96	16.47	13	A666
	3600	575	184T	E2137	184TTFW16020	✓	10:1	\$882	E9	88.5	4.8	96	16.47	13	A666
	3600	575	184T	U615A	184TTFC6006	✓	10:1	\$959	E9	88.5	5.2	112	16.52	d	N/A
	1800	200	184T	E2163	184TTFW16038	✓	10:1	\$810	E9	89.5	14.7	94	14.97	13	A666
	1800	230/460	184T	E2113	184TTFW16026	✓	10:1	\$810	E9	89.5	12.8/6.4	94	14.97	13	A666
	1800	230/460	184T	E202-P	184TTFN16056	✓	10:1	\$1,003	E9	89.5	12.4/6.2	109	17.85	P	A644
	1800	208-230/460	184T	U618A	184TTFC6027	✓	10:1	\$873	E9	89.5	14.0-12.8/6.4	109	16.80		N/A
	1800	575	184T	E2138	184TTFW16040	✓	10:1	\$810	E9	89.5	5.1	94	14.97	13	A666
	1800	575	184T	U620A	184TTFC6031	✓	10:1	\$873	E9	89.5	5.3	109	16.80	d	N/A
	1200	200	215T	E2164	215TTFW16081		10:1	\$1,326	E9	90.2	16.1	135	20.23		A609
	1200	230/460	215T	E2114	215TTFW16076	✓	10:1	\$1,326	E9	90.2	14.0/7.0	135	20.23		A609
	1200	208-230/460	215T	U621A	215TTFC6077	✓	10:1	\$1,377	E9	90.2	15.8-14.4/7.2	176	19.61	d	N/A
	1200	575	215T	E2139	215TTFW16080		10:1	\$1,326	E9	90.2	5.6	135	20.23		A609
7 1/2	3600	230/460	213T	E2115	213TTFW16001	✓	10:1	\$1,066	E9	90.2	17.8/8.9	116	20.97		A609
	3600	230/460	213T	E218	213TTTS6001		2:1	\$1,184	E9	90.2	17.8/8.9	185	15.69	N,NE	A206
	3600	575	213T	E2140	213TTFW16020		10:1	\$1,066	E9	90.2	7.1	116	20.97		A609
	3600	575	213T	U671A	213TTFC6006	✓	10:1	\$1,147	E9	90.2	7.3	147	18.19	d	N/A
	1800	230/460	213T	E2116	213TTFW16026	✓	10:1	\$1,000	E9	91.7	21.6/10.8	144	18.70		A667
	1800	230/460	213T	E203-P	213TTFN16326	✓	10:1	\$1,234	E9	91.7	20./10.0	185	19.63	P	A206
	1800	208-230/460	213T	U629A	213TTFC6027	✓	10:1	\$1,074	E9	91.7	20.5-18.6/9.3	155	18.19		N/A
	1800	575	213T	E2141	213TTFW16040	✓	10:1	\$1,000	E9	91.7	8.6	144	18.70		A667
	1800	575	213T	U631A	213TTFC6031	✓	10:1	\$1,074	E9	91.7	8.9	155	18.19	d	N/A
	1200	230/460	254T	E2117	254TTFL16076	✓	10:1	\$1,744	E9	91.0	19.8/9.9	162	23.40		A1209
	1200	208-230/460	254T	U633A	254TTFC6077	✓	10:1	\$1,806	E9	91.0	24.2-22.2/11.1	249	23.19	d	N/A
	1200	230/460	254T	E235	254TTFNA6076		20:1	\$1,872	E9	91.0	19.8/9.9	223	23.52		A284
	1200	575	254T	E2142	254TTFL16077		10:1	\$1,744	E9	91.0	7.9	162	23.40		A1209
	1200	575	254T	E005	254TTFC6081	✓	10:1	\$1,806	E9	91.0	8.5	249	23.19	d	N/A

GENERAL PURPOSE THREE PHASE

Catalog numbers (Cat No.) highlighted in bold blue have efficiency levels that meet EISA requirements

Blue shaded areas are Cast Iron Frames

* Requires nameplate modification

Continued on next page.

NEMA Premium® XRI® Efficiency

Three Phase, Totally Enclosed

Rigid Base

HP	RPM	VOLTS	FRAME	CAT. NO.	MODEL NO.	STOCK	CT SPEED RANGE*	LIST PRICE	MULT. SYMB.	NOM. EFF.	F.L. AMPS	WEIGHT	"C" DIM.	FOOT NOTES	C FACE KITS
30	1800	575	286T	E817A	286TTFC6031	✓	10:1	\$2,940	E9	93.6	29.7	432	27.83		N/A
	1200	230/460	326T	E240	326TTFS6076	✓	20:1	\$5,162	E9	93.0	77.0/38.5	725	30.37		A214
40	3600	230/460	324TS	E224	324TSTFS6001	✓	2:1	\$4,267	E9	93.6	94.0/47.0	675	27.37		A214
	3600	575	324TS	E319	324TSTFS6005		2:1	\$4,267	E9	94.1	37.5	675	27.37		A214
	3600	575	324TS	E011	324TSTFC6006	✓	10:1	\$4,267	E9	92.4	35.4	504	28.03		N/A
	1800	230/460	324T	E209	324TTFS6026	✓	20:1	\$3,905	E9	94.1	95.0/47.5	528	30.37		A214
	1800	230/460	324T	E209-P	324TTFS16066	✓	20:1	\$4,504	E9	94.1	95.0/47.5	528	30.37	P	A214
	1800	208-230/460	324TS	E816A	324TSTFC6036	✓	10:1	\$3,905	E9	94.1	101-92.0/46.0	598	29.53		N/A
	1800	575	324T	E311	324TTFS6030	✓	20:1	\$3,905	E9	94.1	39.0	528	30.37		A214
	1200	230/460	364T	E241A	364TTFS16083	✓	20:1@	\$7,637	E9	94.1	100/50.0	950	31.50		A395
	1200	230/460	364T	E241A	364TTFS16083	✓	20:1@	\$7,637	E9	94.1	100/50.0	950	31.50		A395
50	3600	230/460	326TS	E225	326TSTFS6001	✓	2:1	\$5,520	E9	93.6	116/58.0	725	28.87		A214
	3600	575	326TS	E320	326TSTFS6005		2:1	\$5,520	E9	94.5	46.5	725	28.87		A214
	3600	575	326TS	E013	326TSTFC6006	✓	10:1	\$5,520	E9	93.0	44.5	554	29.53		N/A
	1800	230/460	326T	E210	326TTFS6026	✓	20:1@	\$4,796	E9	94.5	120/60.0	775	31.87		A214
	1800	230/460	326T	E210-P	326TTFS16073	✓	20:1@	\$5,515	E9	94.5	120/60.0	775	31.87	P	A214
	1800	208-230/460	326TS	E801A	326TSTFC6036	✓	10:1	\$4,796	E9	94.5	129-117/58.5	681	29.53		N/A
	1800	575	326T	E312	326TTFS6030	✓	20:1@	\$4,796	E9	94.5	48.0	775	31.87		A214
	1800	575	326T	U659A	326TTFC6031	✓	10:1	\$4,796	E9	94.5	47.9	681	31.02	d	N/A
	1200	230/460	365T	E242A	365TTFS16083	✓	20:1@	\$8,569	E9	94.1	123/61.5	1000	32.50		A395
	1200	208-230/460	365T	E993A	365TTFC6087	✓	10:1	\$8,569	E9	94.1	136-124/62	672	33.62	d	N/A
	1200	208-230/460	365T	E993A	365TTFC6087	✓	10:1	\$8,569	E9	94.1	136-124/62	672	33.62	d	N/A
	60	3600	230/460	364TS	E226	364TSTFS6001	✓	2:1	\$7,263	E9	94.5	134/67.0	925	29.38	
3600		575	364TS	E321	364TSTFS6005		2:1	\$7,263	E9	94.5	53.5	925	29.38		A396
3600		575	364TS	E015	364TSTFC6006	✓	10:1	\$7,263	E9	93.6	53.7	735	30.51		N/A
1800		230/460	364T	E211	364TTFS6036	✓	20:1@	\$6,880	E9	95.0	138/69.0	1000	31.50		A395
1800		208-230/460	364TS	E802A	364TSTFC6026	✓	10:1	\$6,880	E9	95.4	151-139/69.5	947	32.64		N/A
1800		575	364T	E313	364TTFS6040	✓	20:1@	\$6,880	E9	95.0	55.0	1000	31.50		A395
1200		230/460	404T	E243	404TTFS6086	✓	20:1@	\$9,414	E9	94.5	144/72.0	1200	35.62		A223
1200		230/460	404T	E243	404TTFS6086	✓	20:1@	\$9,414	E9	94.5	144/72.0	1200	35.62		A223
75	3600	230/460	365TS	E227	365TSTFS6001	✓	2:1	\$9,120	E9	94.5	168/84.0	1025	30.38		A396
	3600	208-230/460	365TS	E991A	365TSTFC6003	✓	10:1	\$9,120	E9	93.6	186-169/84.5	780	31.50	d	N/A
	3600	575	365TS	E322	365TSTFS6002		2:1	\$9,120	E9	94.5	67.0	1025	30.38		A396
	3600	575	365TS	E016	365TSTFC6006	✓	10:1	\$9,120	E9	93.6	67.3	780	31.50		N/A
	1800	230/460	365T	E212	365TTFS6036	✓	20:1@	\$8,722	E9	95.4	172/86.0	1100	32.50		A395
	1800	208-230/460	365TS	E804A	365TSTFC6026	✓	10:1	\$8,722	E9	95.8	188-171/85.5	1014	33.62		N/A
	1800	575	365T	E315	365TTFS6040	✓	20:1@	\$8,722	E9	95.4	69.0	1100	32.50		A395
	1800	575	365T	E805A	365TTFC6041	✓	10:1	\$8,722	E9	95.4	71.0	733	33.62	d	N/A
	1200	230/460	405T	E244	405TTFS6086	✓	20:1@	\$11,081	E9	94.5	180/90	1300	37.12		A223
	1200	230/460	405T	E244	405TTFS6086	✓	20:1@	\$11,081	E9	94.5	180/90	1300	37.12		A223
100	3600	230/460	405TS	E228	405TSTFS6001	✓	2:1	\$12,220	E9	95.0	216/108	1250	34.13		A226
	3600	575	405TS	E323	405TSTFS6005		2:1	\$12,220	E9	95.0	86.5	1250	34.13		A226
	1800	230/460	405T	E213	405TTFS6036	✓	20:1@	\$10,776	E9	95.4	226/113	1220	37.12		A223
	1800	230/460	405TS	E808A	405TSTFS16033	✓	20:1@	\$10,776	E9	95.4	226/113	1220	34.13		A226
	1800	575	405T	E314	405TTFS6040	✓	20:1@	\$10,776	E9	95.4	90.5	1220	37.12		A223
	1200	230/460	444T	E328	444TTFN6086	✓	20:1@	\$16,341	E9	95.0	248/124	2000	41.25		A620

Catalog numbers (Cat No.) highlighted in bold blue have efficiency levels that meet EISA requirements

Blue shaded areas are Cast Iron Frames

* Requires nameplate modification

@ Requires larger fan

Continued on next page.

GENERAL PURPOSE THREE PHASE

NEMA Premium® XRI® Efficiency

Three Phase, Totally Enclosed

Rigid Base

HP	RPM	VOLTS	FRAME	CAT. NO.	MODEL NO.	STOCK	CT SPEED RANGE*	LIST PRICE	MULT. SYMB.	NOM. EFF.	F.L. AMPS	WEIGHT	"C" DIM.	FOOT NOTES	C FACE KITS
125	3600	460	444TS	E229	444TSTFS6001	✓	2:1	\$15,975	E9	95.4	136	1750	37.50	PW	N/A
	3600	575	444TS	E324	444TSTFS16002		2:1	\$15,975	E9	95.4	109	1750	37.50	PW	A232
	1800	460	444T	E214	444TTFS6036	✓	20:1@	\$14,186	E9	95.4	141	1850	41.25	PW	A229
	1800	460	444TS	E810A	444TSTFN16033	✓	20:1@	\$14,186	E9	95.4	141	1850	37.50		A621
	1800	575	444T	E316A	444TTFN6044		20:1@	\$14,186	E9	95.4	117	1752	43.35	PW	A620
	1200	460	445T	E246	445TTFN6086	✓	20:1@	\$18,603	E9	95.0	155	2050	43.19		A620
150	3600	460	445TS	E230	445TSTFN6001	✓	2:1	\$19,191	E9	95.8	165	2050	39.44		A621
	1800	460	445T	E215	445TTFN6036	✓	20:1@	\$16,493	E9	95.8	172	2050	43.19		A620
	1800	460	445TS	E811A	445TSTFN6026	✓	20:1@	\$16,493	E9	95.8	172	2050	39.60	68	A621
	1800	575	445T	E317	445TTFN6037		20:1@	\$16,493	E9	95.8	138	2050	43.19	PW	A620
	1200	460	445T	E289	445TTFN6087		20:1@	\$20,813	E9	95.8	181	2500	43.19	RB	N/A
200	3600	460	445TS	E342	445TSTFN16004	✓	2:1	\$24,277	E9	95.8	222	2300	39.44		A621
	1800	460	445T	E247	445TTFN6038	✓	20:1@	\$20,058	E9	96.2	226	2350	43.19	RB	N/A
	1800	460	445T	U669A	445TTFN6028		20:1@	\$20,058	E9	96.2	226	2350	43.35		A620
	1800	460	445TS	E813A	445TSTFN16033	✓	20:1@	\$20,058	E9	96.2	226	2350	39.60		A621
	1800	575	445T	E326	445TTFN6039		20:1@	\$20,058	E9	96.2	181	2350	43.19	RB	N/A
	1200	460	447/9T	E282	449TTFS6088	✓	20:1@	\$25,479	E9	95.8	240	2900	51.69	H,RB	N/A
	1200	460	447/9T	E814A	449TTFS16094	✓	20:1@	\$25,479	E9	95.8	240	2746	51.86	H,RB	N/A
	250	3600	460	447/9TS	E271	449TSTFS6003		2:1	\$30,617	E9	96.5	274	2700	47.88	H
1800	460	445T	E287	445TTFN6040		20:1@	\$23,645	E9	95.8	285	2150	43.35	RB,X	N/A	
	460	447/9T	E276	449TTFS6038		20:1@	\$25,419	E9	96.5	285	2850	51.69	H,RB	N/A	
	1200	460	L447/9T	E283	449TTFS6087		20:1@	\$29,288	E9	95.8	300	3350	51.69	H,RB	N/A
	300	3600	460	447/9TS	E272	449TSTFS6002		2:1	\$39,686	E9	96.2	330	2700	47.88	H
1800	460	447/9T	E277	449TTFS6037		20:1@	\$28,756	E9	96.5	339	3150	51.69	H,RB	N/A	
	1200	460	L447/9T	E284	449TTFS6390		N/A	\$38,669	E9	95.8	362	3850	56.71	H,RB	N/A
350	3600	460	447/9TS	E273	449TSTFS6001		2:1	\$45,511	E9	96.2	382	2950	47.88		A624
	1800	460	447/9T	E293	449TTFS16333		2:1	\$37,524	E9	96.2	395	3400	51.88	H,RB	N/A
400	1800	460	447/9T	E291	449TTFS16334		2:1	\$37,865	E9	96.5	460	3800	56.71	H	A623
450	1800	460	L447/9T	E292	449TTFS6065		N/A	\$38,822	E9	96.5	515	3800	56.71	H	A623

* Requires nameplate modification

@ Requires larger fan

C-Face Footed (Rigid Base)

HP	RPM	VOLTS	FRAME	CAT. NO.	MODEL NO.	STOCK	CT SPEED RANGE	LIST PRICE	MULT. SYMB.	NOM. EFF.	F.L. AMPS	WEIGHT	"C" DIM.	FOOT NOTES
1	3600	208-230/460	56C	E2000	056T34F5940	✓	10:1	\$592	E9	80.0	3.0-2.8/1.4	28	11.31	
	1800	230/460	143TC	E2001A	143TTFR16053	✓	10:1	\$502	E9	85.5	3.2/1.6	32	13.75	P
	1200	208-230/460	145TC	E2002	145TTFR6078	✓	10:1	\$573	E9	82.5	3.8-3.8/1.9	45	13.75	
1 1/2	3600	208-230/460	143TC	E2003	143TTFR5582	✓	10:1	\$551	E9	84.0	4.4-4.0/2.0	38	13.75	
	1800	230/460	145TC	E2004A	145TTFR16331	✓	10:1	\$546	E9	86.5	4.8/2.4	34	13.75	P
	1200	208-230/460	182TC	E2005	182TTFW6076	✓	10:1	\$749	E9	87.5	6.0-5.1/2.6	82	14.47	13
2	3600	208-230/460	145TC	E2006	145TTFR3002	✓	10:1	\$610	E9	85.5	5.2-4.8/2.4	48	13.75	
	1800	230/460	145TC	E2007A	145TTFR16329	✓	10:1	\$599	E9	86.5	5.8/2.9	50	14.25	P
	1200	208-230/460	184TC	E2008	184TTFW6076	✓	10:1	\$858	E9	88.5	7.4-6.4/3.2	94	14.97	13
3	3600	208-230/460	182TC	E2009	182TTFW6001	✓	10:1	\$791	E9	87.5	8.4-7.8/3.9	81	13.97	13
	1800	208-230/460	182TC	E2010	182TTFW6026	✓	10:1	\$749	E9	89.5	8.4-7.8/3.9	87	13.97	13,P
	1200	208-230/460	213TC	E2011	213TTFW6076	✓	10:1	\$1,047	E9	89.5	9.2-8.8/4.4	125	19.47	
5	3600	208-230/460	184TC	E2012	184TTFW6001	✓	10:1	\$917	E9	88.5	13.0-12.0/6.0	85	17.19	13
	1800	208-230/460	184TC	E2013	184TTFW6026	✓	10:1	\$874	E9	90.2	13.7-12.6/6.3	87	14.97	13,P
	1200	208-230/460	215TC	E2014	215TTFW6076	✓	10:1	\$1,348	E9	90.2	15.0-14.0/7.0	160	20.97	
7 1/2	3600	208-230/460	213TC	E2015	213TTFW6001	✓	10:1	\$1,127	E9	91.7	19.7-17.8/8.9	116	20.97	
	1800	230/460	213TC	E2016A	213TTFW16039	✓	10:1	\$1,079	E9	91.7	19.4/9.7	143	20.97	P
10	3600	208-230/460	215TC	E2018	215TTFW6001	✓	10:1	\$1,199	E9	91.7	26.4-23.6/11.8	230	22.22	
	1800	208-230/460	215TC	E2019	215TTFW6026	✓	10:1	\$1,164	E9	91.7	28.0-25.6/12.8	164	22.22	d
	1800	230/460	215TC	E2019A	215TTFW16047	✓	10:1	\$1,228	E9	91.7	25.6/12.8	164	22.22	P

Catalog numbers (Cat No.) highlighted in bold blue have efficiency levels that meet EISA requirements

Blue shaded areas are Cast Iron Frames

General Purpose, Three Phase Globetrotter® NEMA Premium® Efficiency Totally Enclosed

Features:

☛ Meets or exceeds NEMA Premium® efficiencies

NEMA Premium® models are in compliance with EISA2007

- Cast iron frame and brackets
- Inverter Duty 10:1 Variable Torque and 10:1 Constant Torque, 1.0 SF (except as noted)
- 1.15 Service Factor
- Class F Insulation
- Standard assembly F1, reversible to F2 assembly
- UL Recognized, CSA Certified, CE Mark
- Three year warranty



Rigid Base

Suitable for use on VFD per guidelines on page 17.

HP	RPM	VOLTS	FRAME	CAT. NO.	MODEL NO.	STOCK	LIST PRICE	MULT. SYMB.	NOM. EFF.	F.L. AMPS	APPROX WGT. LBS	"C" DIM.	FOOT NOTES	C FACE KITS
1 1/2	1200	230/460	182T	GT1005	182TTFC6076	✓	\$697	E1	87.5	4.8/2.4	89	14.80	75	A644
	1200	575	182T	GT1105	182TTFC6080	✓	\$697	E1	87.5	1.9	89	14.80	75	A644
2	1200	208-230/460	184T	GT1008	184TTFC6076	✓	\$840	E1	88.5	6.0/3.0	125	15.81	75	A644
	1200	575	184T	GT1108	184TTFC6080	✓	\$840	E1	88.5	2.4	125	15.81	75	A644
3	3600	208-230/460	182T	GT1009	182TTFC6001	✓	\$814	E1	86.5	7.6/3.8	94	14.80	A, 75	A644
	3600	575	182T	GT1109	182TTFC6005	✓	\$814	E1	86.5	3.1	94	14.80	75	A644
	1800	208-230/460	182T	GT1010	182TTFC6026	✓	\$761	E1	89.5	7.8/3.9	102	14.80	75	A644
	1800	575	182T	GT1110	182TTFC6030	✓	\$761	E1	89.5	3.1	102	14.80	75	A644
	1200	208-230/460	213T	GT1011	213TTFC6076	✓	\$1,143	E1	89.5	8.6/4.3	173	18.23	75	A206
	1200	575	213T	GT1111	213TTFC6080	✓	\$1,143	E1	89.5	3.5	173	18.23	75	A206
5	3600	208-230/460	184T	GT1012	184TTFC6001	✓	\$905	E1	88.5	12.0/6.0	109	15.81	A, 75	A644
	3600	575	184T	GT1112	184TTFC6005	✓	\$905	E1	88.5	4.8	109	15.81	75	A644
	1800	208-230/460	184T	GT1013	184TTFC6026	✓	\$856	E1	90.2	12.4/6.2	117	15.81	A, 75	A644
	1800	575	184T	GT1113	184TTFC6030	✓	\$856	E1	89.5	5.0	117	15.81	75	A644
	1200	208-230/460	215T	GT1014	215TTFC6076	✓	\$1,418	E1	90.2	14/7.0	203	19.73	75	A206
	1200	575	215T	GT1114	215TTFC6080	✓	\$1,418	E1	89.5	5.6	203	19.73	75	A206
7 1/2	3600	208-230/460	213T	GT1015	213TTFC6001	✓	\$1,186	E1	89.5	17.8/8.9	185	18.23	A, 75	A206
	3600	575	213T	GT1115	213TTFC6005	✓	\$1,186	E1	89.5	7.1	185	18.23	75	A206
	1800	230/460	213T	GT1016	213TTFC6026	✓	\$1,126	E1	91.7	18.6/9.3	194	18.23	75	A206
	1800	575	213T	GT1116	213TTFC6030	✓	\$1,126	E1	91.7	7.5	194	18.23	75	A206
	1200	208-230/460	254T	GT1017	254TTFCA6076	✓	\$1,876	E1	91.0	20.4/10.2	223	23.70	75	A173
	1200	575	254T	GT1117	254TTFCA6080	✓	\$1,876	E1	91.0	8.4	223	26.60	75	A173
10	3600	208-230/460	215T	GT1018	215TTFC6001	✓	\$1,385	E1	90.2	22.8/11.4	217	19.73	75	A206
	3600	575	215T	GT1118	215TTFC6005	✓	\$1,385	E1	90.2	9.1	217	19.73	75	A206
	1800	230/460	215T	GT1019	215TTFC6026	✓	\$1,356	E1	91.7	24.4/12.2	225	19.73	75	A206
	1800	575	215T	GT1119	215TTFC6030	✓	\$1,356	E1	91.7	9.8	225	19.73	75	A206
	1200	208-230/460	256T	GT1020	256TTFCA6076	✓	\$2,291	E1	91.0	26.8/13.4	368	25.43	75	A173
	1200	575	256T	GT1120	256TTFCA6080	✓	\$2,291	E1	91.0	11.2	368	27.80	75	A173
15	3600	208-230/460	254T	GT1021	254TTFCA6001	✓	\$1,854	E1	91.0	34/17.0	350	23.70	75	A172
	3600	575	254T	GT1121	254TTFCA6005	✓	\$1,854	E1	91.0	13.6	350	26.60	75	A172
	1800	208-230/460	254T	GT1022	254TTFCA6026	✓	\$1,741	E1	92.4	37/18.5	375	23.70	75	A173
	1800	575	254T	GT1122	254TTFCA6030	✓	\$1,741	E1	92.4	14.8	375	26.60	75	A173
	1200	208-230/460	284T	GT1023	284TTFCA6076	✓	\$2,981	E1	91.7	39.5/19.8	475	27.83		A175
	1200	575	284T	GT1123	284TTFCA6080	✓	\$2,981	E1	91.7	15.9	475	30.16		A175
20	3600	208-230/460	256T	GT1024	256TTFCA6001	✓	\$2,253	E1	91.0	46.0/23.0	375	27.80	75	A172
	3600	575	256T	GT1124	256TTFCA6005	✓	\$2,253	E1	91.0	18.4	375	27.80	75	A172
	1800	208-230/460	256T	GT1025	256TTFCA6026	✓	\$2,189	E1	93.0	48.0/24.0	425	27.80	75	A173
	1800	575	256T	GT1125	256TTFCA6030	✓	\$2,189	E1	93.0	19.6	425	27.80	75	A173
	1200	208-230/460	286T	GT1026	286TTFCA6076	✓	\$3,414	E1	91.7	52.0/26.0	550	31.34		A175
	1200	575	286T	GT1126	286TTFCA6080	✓	\$3,414	E1	91.7	20.8	550	31.34		A175

GENERAL PURPOSE THREE PHASE

Catalog numbers (Cat No.) highlighted in bold blue have efficiency levels that meet EISA requirements

Blue shaded areas are Cast Iron Frames

Continued on next page.

General Purpose, Three Phase Globetrotter® NEMA Premium® Efficiency

Totally Enclosed

Rigid Base

HP	RPM	VOLTS	FRAME	CAT. NO.	MODEL NO.	STOCK	LIST PRICE	MULT. SYMB.	NOM. EFF.	F.L. AMPS	APPROX WGT. LBS	"C" DIM.	FOOT NOTES	C FACE KITS
25	3600	208-230/460	284TS	GT1027	284TSTFCA6001	✓	\$2,776	E1	91.7	55.5/27.7	475	28.82		A174
	3600	575	284TS	GT1127	284TSTFCA6005	✓	\$2,776	E1	91.7	22.4	475	28.82		A174
	1800	208-230/460	284T	GT1028	284TTFCA6026	✓	\$2,557	E1	93.6	62.0/31.0	500	30.16		A175
	1800	575	284T	GT1128	284TTFCA6030	✓	\$2,557	E1	93.6	24.4	500	30.16		A175
	1200	208-230/460	324T	GT1029	324TTFCA6076	✓	\$4,491	E1	93.0	66.0/33.0	675	32.68		A177
	1200	575	324T	GT1129	324TTFCA6080	✓	\$4,491	E1	93.0	26.8	675	32.68		A177
30	3600	208-230/460	286TS	GT1030	286TSTFCA6001	✓	\$3,242	E1	91.7	66.0/33.0	500	30.00		A174
	3600	575	286TS	GT1130	286TSTFCA6005	✓	\$3,242	E1	91.7	27.2	500	30.00		A174
	1800	208-230/460	286T	GT1031	286TTFCA6026	✓	\$2,975	E1	93.6	73.0/36.5	525	31.34		A175
	1800	575	286T	GT1131	286TTFCA6030	✓	\$2,975	E1	93.6	29.2	252	31.34		A175
	1200	208-230/460	326T	GT1032	326TTFCA6076	✓	\$4,817	E1	93.0	80.0/40.0	725	33.86		A177
	1200	575	326T	GT1132	326TTFCA6080	✓	\$4,817	E1	93.0	32.0	725	33.86		A177
40	3600	208-230/460	324TS	GT1033	324TSTFCA6001	✓	\$4,276	E1	92.4	88.0/44.0	675	31.26		A176
	3600	575	324TS	GT1133	324TSTFCA6005	✓	\$4,276	E1	92.4	35.0	675	31.26		A176
	1800	208-230/460	324T	GT1034	324TTFCA6026	✓	\$3,913	E1	94.1	94.0/47.0	750	32.68		A177
	1800	575	324T	GT1134	324TTFCA6030	✓	\$3,913	E1	94.1	37.5	750	32.68		A177
	1200	208-230/460	364T	GT1035	364TTFCA6086	✓	\$6,665	E1	94.1	94.0/47.0	950	36.61		A179
	1200	575	364T	GT1135	364TTFCA6080	✓	\$6,665	E1	94.1	38.5	950	36.61		A179
50	3600	208-230/460	326TS	GT1036	326TSTFCA6001	✓	\$4,880	E1	93.0	109/54.5	725	32.44		A176
	3600	575	326TS	GT1136	326TSTFCA6005	✓	\$4,880	E1	93.0	43.5	725	32.44		A176
	1800	208-230/460	326T	GT1037	326TTFCA6026	✓	\$4,804	E1	94.5	119/59.5	775	33.86		A177
	1800	575	326T	GT1137	326TTFCA6030	✓	\$4,804	E1	94.5	47.5	775	33.86		A177
	1200	208-230/460	365T	GT1038	365TTFCA6086	✓	\$7,576	E1	94.1	117/58.5	1000	38.39		A179
	1200	575	365T	GT1138	365TTFCA6080	✓	\$7,576	E1	94.1	47.0	1000	38.39		A179
60	3600	208-230/460	364TS	GT1039	364TSTFCA6001	✓	\$6,635	E1	93.6	132/66.0	925	34.57		A178
	3600	575	364TS	GT1139	364TSTFCA6005	✓	\$6,635	E1	93.6	53.0	925	34.57		A178
	1800	208-230/460	364T	GT1040	364TTFCA6036	✓	\$6,555	E1	95.0	138/69.0	1000	36.61		A179
	1800	575	364T	GT1140	364TTFCA6040	✓	\$6,555	E1	95.0	55.0	1000	36.61		A179
	1200	208-230/460	404T	GT1041	404TTFCA6086	✓	\$8,876	E1	94.5	140/70.0	1200	42.72		A425
	1200	575	404T	GT1141	404TTFCA6080	✓	\$8,876	E1	94.5	56.0	1200	42.72		A425
75	3600	208-230/460	365TS	GT1042	365TSTFCA6001	✓	\$8,241	E1	94.1	164/82.0	1025	36.34		A178
	3600	575	365TS	GT1142	365TSTFCA6002	✓	\$8,241	E1	93.6	65.5	1025	36.34		A178
	1800	208-230/460	365T	GT1043	365TTFCA6036	✓	\$8,053	E1	95.4	170/85.0	1100	38.39		A179
	1800	575	365T	GT1143	365TTFCA6040	✓	\$8,053	E1	95.4	69.0	1100	38.39		A179
	1200	208-230/460	405T	GT1044	405TTFCA6086	✓	\$10,449	E1	94.5	174/87.0	1300	42.72		A425
	1200	575	405T	GT1144	405TTFCA6080	✓	\$10,449	E1	94.5	69.5	1300	42.72		A425
100	3600	208-230/460	405TS	GT1045	405TSTFCA6001	✓	\$9,998	E1	94.5	216/108	1250	39.76		A424
	3600	575	405TS	GT1145	405TSTFCA6005	✓	\$9,998	E1	94.1	87.5	1250	39.76		A424
	1800	208-230/460	405T	GT1046	405TTFCA6036	✓	\$9,843	E1	95.4	224/112	1375	42.72		A425
	1800	575	405T	GT1146	405TTFCA6040	✓	\$9,843	E1	95.4	89.5	1375	42.72		A425
	1200	208-230/460	444T	GT1047	444TTFCA6086	✓	\$15,408	E1	95.0	228/114	2000	50.79		A427
	1200	575	444T	GT1147	444TTFCA6080	✓	\$15,408	E1	95.0	91	2000	50.79		A427
125	3600	460	444TS	GT1048	444TSTFCA6001	✓	\$13,965	E1	95.0	136	1750	47.05		A426
	3600	575	444TS	GT1148	444TSTFCA6002	✓	\$13,965	E1	95.0	109	1750	47.05		A426
	1800	460	444T	GT1049	444TTFCA6036	✓	\$13,795	E1	95.4	140	1850	50.79		A427
	1800	575	444T	GT1149	444TTFCA6044	✓	\$13,795	E1	95.4	112	1850	50.79		A427
	1200	460	445T	GT1050	445TTFCA6086	✓	\$16,079	E1	95.0	142	2050	50.79		A427
	1200	575	445T	GT1150	445TTFCA6080	✓	\$16,079	E1	95.0	114	2050	50.79		A427

GENERAL PURPOSE THREE PHASE

Catalog numbers (Cat No.) highlighted in bold blue have efficiency levels that meet EISA requirements

Blue shaded areas are Cast Iron Frames

Continued on next page.

General Purpose, Three Phase Globetrotter® NEMA Premium® Efficiency

Totally Enclosed

Rigid Base

HP	RPM	VOLTS	FRAME	CAT. NO.	MODEL NO.	STOCK	LIST PRICE	MULT. SYMB.	NOM. EFF.	F.L. AMPS	APPROX WGT. LBS	"C" DIM.	FOOT NOTES	C FACE KITS
150	3600	460	445TS	GT1051	445TSTFC6001	✓	\$17,154	E1	95.0	162	2050	47.05		A426
	3600	575	445TS	GT1151	445TSTFC6005	✓	\$17,154	E1	95.0	130	2050	47.05		A426
	1800	460	445T	GT1052	445TTFC6036	✓	\$16,199	E1	95.8	165	2050	50.79		A427
	1800	575	445T	GT1152	445TTFC6037	✓	\$16,199	E1	95.8	132	2050	50.79		A427
	1200	460	447T	GT1053	447TTFC6087	✓	\$20,444	E1	95.8	170	2500	55.91		A429
	1200	575	447T	GT1153	447TTFC6080	✓	\$20,444	E1	95.8	136	2500	55.91		A429
200	3600	460	447TS	GT1054	447TSTFC16004	✓	\$20,031	E1	95.4	215	2300	52.17		A428
	3600	575	447TS	GT1154	447TSTFC6005	✓	\$20,031	E1	95.4	172	2300	52.17		A428
	1800	460	447T	GT1055	447TTFC6038	✓	\$19,701	E1	96.2	225	2350	55.91	A,V	A429
	1800	575	447T	GT1155	447TTFC6039	✓	\$19,701	E1	96.2	180	2350	55.91	V	A429
	1200	460	449T	GT1056	449TTFC6088	✓	\$21,773	E1	95.8	228	2900	55.91	V	A429
	1200	575	449T	GT1156	449TTFC6080	✓	\$21,773	E1	95.8	182	2900	55.91	V	A429

C-Face Footless

HP	RPM	VOLTS	FRAME	CAT. NO.	MODEL NO.	STOCK	LIST PRICE	MULT. SYMB.	NOM. EFF.	F.L. AMPS	WEIGHT	"C" DIM.	FOOT NOTES
1 1/2	1200	230/460	182TC	GT1305	182TTFB6079	✓	\$887	E1	87.5	4.8/2.4	82	15.75	
2	1200	208-230/460	184TC	GT1308	184TTFB6079	✓	\$994	E1	88.5	6.0/3.0	94	16.73	
3	3600	208-230/460	182TC	GT1309	182TTFB6004	✓	\$806	E1	86.5	7.6/3.8	83	15.75	A
	1800	208-230/460	182TC	GT1310	182TTFB6029	✓	\$797	E1	89.5	7.8/3.9	87	15.75	
5	1200	208-230/460	213TC	GT1311	213TTFBA6079	✓	\$1,179	E1	89.5	8.6/4.3	115	19.53	
	3600	208-230/460	184TC	GT1312	184TTFB6004	✓	\$894	E1	88.5	13.4/6.7	95	16.73	A
	1800	208-230/460	184TC	GT1313	184TTFB6029	✓	\$869	E1	89.5	12.4/6.2	110	16.73	
7 1/2	1200	208-230/460	215TC	GT1314	215TTFBA6079	✓	\$1,475	E1	89.5	14.0/7.0	135	21.02	
	3600	208-230/460	213TC	GT1315	213TTFBA6004	✓	\$1,258	E1	89.5	17.8/8.9	116	19.53	
	1800	230/460	213TC	GT1316	213TTFBA6029	✓	\$1,011	E1	91.7	18.6/9.3	143	19.53	
10	3600	208-230/460	215TC	GT1318	215TTFBA6004	✓	\$1,329	E1	90.2	22.8/11.4	137	21.02	
	1800	230/460	215TC	GT1319	215TTFBA6029	✓	\$1,295	E1	91.7	24.4/12.2	164	21.02	

C-Face Footed (Rigid Base)

HP	RPM	VOLTS	FRAME	CAT. NO.	MODEL NO.	STOCK	LIST PRICE	MULT. SYMB.	NOM. EFF.	F.L. AMPS	WEIGHT	"C" DIM.	FOOT NOTES
1	1800	208-230/460	143TC	GT1201	143TTFR6032	✓	\$478	E1	85.5	3.3/1.65	42	13.87	
	1800	575	143TC	GT1401	143TTFR16039	✓	\$478	E1	85.5	1.3	42	13.87	A
	1200	208-230/460	145TC	GT1202	145TTFR16079	✓	\$626	E1	82.5	3.8-3.8/1.9	49	14.87	
1 1/2	3600	208-230/460	143TC	GT1203	143TTFR6010	✓	\$510	E1	84.0	4.0/2.0	39	13.87	
	3600	575	143TC	GT1403	143TTFR16003	✓	\$510	E1	84.0	1.6	39	13.37	
	1800	208-230/460	145TC	GT1204	145TTFR6058	✓	\$485	E1	86.5	4.6/2.3	44	14.37	
	1800	575	145TC	GT1404	145TTFR16046	✓	\$485	E1	86.5	2.0	44	14.37	A
	1200	208-230/460	182TC	GT1205	182TTFB6078	✓	\$701	E1	87.5	4.8/2.4	91	15.75	
2	3600	208-230/460	145TC	GT1206	145TTFR6009	✓	\$559	E1	85.5	5.6-5.2/2.6	46	14.37	
	3600	575	145TC	GT1406	145TTFR16005	✓	\$559	E1	85.5	2.0	46	14.37	
	1800	208-230/460	145TC	GT1207	145TTFR6040	✓	\$520	E1	86.5	6.0/3.0	49	14.87	A
	1800	575	145TC	GT1407	145TTFR16047	✓	\$520	E1	86.5	2.4	49	14.87	A
	1200	230/460	184TC	GT1208	184TTFB6078	✓	\$803	E1	88.5	6.0/3.0	104	16.73	

Catalog numbers (Cat No.) highlighted in bold blue have efficiency levels that meet EISA requirements

Blue shaded areas are Cast Iron Frames

Continued on next page.

General Purpose, Three Phase Globetrotter® NEMA Premium® Efficiency Totally Enclosed

C-Face Footed (Rigid Base)

Suitable for use on VFD per guidelines on page 17.

HP	RPM	VOLTS	FRAME	CAT. NO.	MODEL NO.	STOCK	LIST PRICE	MULT. SYMB.	NOM. EFF.	F.L. AMPS	WEIGHT	"C" DIM.	FOOT NOTES
3	3600	208-230/460	182TC	GT1209	182TTFB6003	✓	\$740	E1	86.5	7.6/3.8	83	15.75	
	3600	575	182TC	GT1409	182TTFB6007	✓	\$740	E1	86.5	3.0	83	15.75	
	1800	208-230/460	182TC	GT1210	182TTFB6028	✓	\$697	E1	89.5	7.8/3.9	105	15.75	
	1800	575	182TC	GT1410	182TTFB6032	✓	\$697	E1	89.5	3.1	108	15.75	
	1200	208-230/460	213TC	GT1211	213TTFBA6078	✓	\$979	E1	89.5	8.6/4.3	164	19.53	
5	3600	208-230/460	184TC	GT1212	184TTFB6003	✓	\$858	E1	88.5	13.4/6.7	97	16.73	
	3600	575	184TC	GT1412	184TTFB6007	✓	\$858	E1	88.5	4.8	97	16.73	
	1800	208-230/460	184TC	GT1213	184TTFB6028	✓	\$775	E1	89.5	12.4/6.2	105	16.73	
	1800	575	184TC	GT1413	184TTFB6032	✓	\$775	E1	89.5	5.1	105	16.73	
	1200	208-230/460	215TC	GT1214	215TTFBA6078	✓	\$1,261	E1	89.5	14.0/7.0	174	21.02	
7 1/2	3600	208-230/460	213TC	GT1215	213TTFBA6003	✓	\$1,054	E1	89.5	17.8/8.9	152	19.53	A
	3600	575	213TC	GT1415	213TTFBA6007	✓	\$1,054	E1	89.5	7.1	152	19.53	
	1800	230/460	213TC	GT1216	213TTFBA6028	✓	\$1,005	E1	91.7	18.6/9.3	161	19.53	
	1800	575	213TC	GT1416	213TTFBA6032	✓	\$1,005	E1	91.7	8.6	161	19.53	
	1200	208-230/460	254TC	GT1217	254TTFCA6078	✓	\$1,945	E1	91.0	20.4/10.2	315	26.60	
10	3600	208-230/460	215TC	GT1218	215TTFBA6003	✓	\$1,178	E1	90.2	22.8/11.4	172	21.02	
	3600	575	215TC	GT1418	215TTFBA6007	✓	\$1,178	E1	90.2	9.4	172	21.02	
	1800	230/460	215TC	GT1219	215TTFBA6028	✓	\$1,143	E1	91.7	24.4/12.2	183	21.02	
	1800	575	215TC	GT1419	215TTFBA6032	✓	\$1,143	E1	91.7	10.7	183	21.02	
	1200	208-230/460	256TC	GT1220	256TTFCA6078	✓	\$2,333	E1	91.0	28.0/14.0	345	27.80	
15	3600	208-230/460	254TC	GT1221	254TTFCA6003	✓	\$1,949	E1	91.0	34.0/17.0	336	26.60	
	3600	575	254TC	GT1421	254TTFCA6007	✓	\$1,949	E1	91.0	14.2	336	26.60	
	1800	208-230/460	254TC	GT1222	254TTFCA6028	✓	\$1,877	E1	92.4	37.0/18.5	325	26.60	
	1800	575	254TC	GT1422	254TTFCA6032	✓	\$1,877	E1	92.4	15.8	325	26.60	
20	3600	208-230/460	256TC	GT1224	256TTFCA6003	✓	\$2,298	E1	91.0	46.0/23.0	375	27.80	
	1800	208-230/460	256TC	GT1225	256TTFCA6028	✓	\$2,245	E1	93.0	49.0/24.5	425	27.80	
25	3600	208-230/460	284TSC	GT1227	284TSTFCA6003	✓	\$2,900	E1	91.7	56.0/28.0	475	28.79	YD
	1800	208-230/460	284TC	GT1228	284TTFCA6028	✓	\$2,673	E1	93.6	61.0/30.5	500	30.16	YD
30	3600	208-230/460	286TSC	GT1230	286TSTFCA6003	✓	\$3,335	E1	91.7	68.0/34.0	500	39.97	YD
	1800	208-230/460	286TC	GT1231	286TTFCA6028	✓	\$3,211	E1	93.6	73.0/36.5	525	31.34	YD
40	3600	208-230/460	324TSC	GT1233	324TSTFCA6003	✓	\$4,435	E1	92.4	88.0/44.0	675	31.18	YD
	1800	208-230/460	324TC	GT1234	324TTFCA6028	✓	\$4,096	E1	94.1	94.0/47.0	750	32.68	YD
50	3600	208-230/460	326TSC	GT1236	326TSTFCA6003	✓	\$5,439	E1	93.0	109/54.5	725	32.36	YD
	1800	208-230/460	326TC	GT1237	326TTFCA6028	✓	\$5,028	E1	94.5	119/59.5	775	33.86	YD
60	3600	208-230/460	364TSC	GT1239	364TSTFCA6003	✓	\$7,212	E1	93.6	132/66.0	925	34.48	YD
	1800	208-230/460	364TC	GT1240	364TTFCA6038	✓	\$6,865	E1	95.0	138/69.0	1000	36.61	YD
75	3600	208-230/460	365TSC	GT1242	365TSTFCA6003	✓	\$8,438	E1	93.6	164/82.0	1025	36.26	YD
	1800	208-230/460	365TC	GT1243	365TTFCA6038	✓	\$8,272	E1	95.4	173/86.5	1100	38.39	YD
100	3600	208-230/460	405TSC	GT1245	405TSTFC6003	✓	\$10,914	E1	94.5	224/112	1250	39.76	YD
	1800	208-230/460	405TC	GT1246	405TTFCA6038	✓	\$9,933	E1	95.4	224/112	1375	42.76	YD

Catalog numbers (Cat No.) highlighted in bold blue have efficiency levels that meet EISA requirements

Blue shaded areas are Cast Iron Frames

GENERAL PURPOSE THREE PHASE

Severe Duty, Totally Enclosed Wet Environment / Car Wash Motor

C-Face Footless, Three Phase

Features:

- 303 Stainless steel shafts with contact lip seal & V-ring slinger
- Rolled Steel construction
- Gray epoxy paint
- Class F insulation
- 1.15 Service Factor (except as noted)
- Automatic thermal protection



Suitable for use on VFD per guidelines on page 17.

HP	RPM	VOLTS	FRAME	CAT. NO.	MODEL NO.	STOCK	LIST PRICE	MULT. SYMB.	NOM. EFF.	F.L. AMPS	WEIGHT	"C" DIM.	FOOT NOTES
1/2	1800	230/460	56C	K606	5K42GN4619	✓	\$472	F3	72.0	2.2/1.1	30	11.19	
3/4	1800	230/460	56C	K607	5K49MN4620	✓	\$518	F3	77.0	3.0/1.5	30	11.69	
1	1800	230/460	56C	K608	5K49MN4618	✓	\$542	F3	77.0	3.8/1.9	30	11.69	
1 1/2	1800	230/460	56C	K610	5K49RN4621	✓	\$598	F3	80.0	5.0/2.5	33	12.19	
2	1800	230/460	56C	K609	5K49TN4622	✓	\$637	F3	81.5	6.2/3.1	38	12.69	17

Blue Chip® Severe Duty / Cooling Tower: Single Speed

Rigid Base, Three Phase

Features:

- Blue Chip® quality, 100% cast iron construction for rigidity and reduced vibration
- Internal and external epoxy paint
- Class F insulation
- 1.15 Service Factor
- Rated 60/50 hertz, 190/380 or 380 volt at next lower horsepower
- Extended grease tubes, regreasable in service
- T-drains provided for effective drainage (Installed in both endshields)
- Suitable for shaft down mounting
- Shaft Slinger
- Forsheda seals on both ends
- Ball Bearings
- Actual test and vibration data supplied with each motor
- UL Recognized and CSA Certified
- Suitable for 10:1 VT and CT (as noted) on VFD
- Three year warranty



Suitable for use on VFD per guidelines on page 17.

HP	RPM	VOLTS	FRAME	CAT. NO.	MODEL NO.	STOCK	CT SPEED RANGE*	LIST PRICE	MULT. SYMB.	NOM. EFF.	F.L. AMPS	WEIGHT	"C" DIM.	FOOT NOTES
3	1800	230/460	182T	U867A	182TTFN6557		10:1	\$986	S3	90.2	8.0/4.0	145	15.87	
5	1800	230/460	184T	U868A	184TTFN6555	✓	10:1	\$1,078	S3	90.2	12.4/6.2	128	17.87	
7 1/2	1800	230/460	213T	U869A	213TTFN6550	✓	10:1	\$1,360	S3	91.7	19.2/9.6	273	18.22	
10	1800	230/460	215T	U870A	215TTFN6546	✓	10:1	\$1,558	S3	91.7	25/12.5	267	19.72	
15	1800	230/460	254T	U871A	254TTFNA16568	✓	10:1	\$2,010	S3	92.4	37.5/18.8	349	23.52	
20	1800	230/460	256T	U872A	256TTFNA16574	✓	10:1	\$2,363	S3	93.0	48.0/24.1	375	25.27	
25	1800	230/460	284T	U873A	284TTFNA16832	✓	10:1	\$2,801	S3	93.6	62.0/31.0	440	26.34	
30	1800	230/460	286T	U874A	286TTFNA16572	✓	10:1	\$3,278	S3	94.1	73.0/36.5	503	27.84	
40	1800	230/460	324T	U875A	324TTFN16837	✓	2:1	\$4,249	S3	94.1	95.0/47.5	567	30.37	
50	1800	230/460	326T	U876A	326TTFN16574	✓	2:1	\$5,351	S3	94.5	120/60.0	644	30.37	
60	1800	230/460	364T	U877A	364TTFN16558	✓	2:1	\$7,489	S3	95.0	138/69.0	1078	31.50	
75	1800	230/460	365T	U878A	365TTFN16827	✓	2:1	\$9,323	S3	95.4	172/86.0	1169	32.50	
100	1800	230/460	405T	U879A	405TTFN16834	✓	2:1	\$11,545	S3	95.4	226/113	1458	37.12	
125	1800	460	444T	U880A	444TTFN16549	✓	2:1	\$14,863	S3	95.4	145	1990	43.35	
150	1800	460	445T	U881A	445TTFN16866		2:1	\$17,698	S3	95.8	172	2343	43.35	
200	1800	460	445T	U882A	445TTFN16852		2:1	\$21,125	S3	96.2	226	2556	43.35	
250	1800	460	445T	U884	445TTFN4575		2:1	\$20,413	S3	95.0	285	2409	43.26	NE

Catalog numbers (Cat No.) highlighted in bold blue have efficiency levels that meet EISA requirements

Blue shaded areas are Cast Iron Frames

* Requires nameplate modification

Blue Chip® Severe Duty, Cooling Tower: Single-Speed TEAO, Rigid Base, Three Phase

Features:

- Meets or exceeds NEMA Premium® efficiencies
- Blue Chip® quality, 100% cast iron construction for rigidity and reduced vibration
- Internal and external epoxy paint
- MAX GUARD® Class F insulation system
- 1.15 Service Factor on sinewave, 1.0 Service Factor on IGBT power
- Rated 60/50 hertz, 190/380 or 380 volt at next lower horsepower
- Extended grease tubes, regreasable in service
- T-drains provided for effective drainage (Installed in both endshields)
- Suitable for all angle mounting
- Inpro/Seals® quality VBX® bearing isolators
- Ball Bearings
- Actual test and vibration data supplied with each motor
- UL Recognized and CSA Certified
- Suitable for 20:1 VT and 20:1 CT on VFD
- Three year warranty



Suitable for use on VFD per guidelines on page 17.

HP	RPM	VOLTS	FRAME	CAT. NO.	MODEL NO.	STOCK	CT SPEED RANGE	LIST PRICE	MULT. SYMB.	NOM. EFF.	F.L. AMPS	WEIGHT	"C" DIM.	FOOT NOTES
3	1800	230/460	182T	U1867	182TTTN	✓	20:1	\$1,228	S3	90.2	8.0/4.0	145	15.87	
5	1800	230/460	184T	U1868	184TTTN	✓	20:1	\$1,424	S3	90.2	12.4/6.2	128	17.87	
7 1/2	1800	230/460	213T	U1869	213TTTN	✓	20:1	\$1,745	S3	91.7	19.2/9.6	273	18.22	
10	1800	230/460	215T	U1870	215TTTN	✓	20:1	\$2,101	S3	91.7	25/12.5	267	19.72	
15	1800	230/460	254T	U1871	254TTT	✓	20:1	\$2,499	S3	92.4	37.5/18.8	349	23.52	
20	1800	230/460	256T	U1872	256TTT	✓	20:1	\$3,114	S3	93.0	48.0/24.1	375	25.27	
25	1800	230/460	284T	U1873	284TTT	✓	20:1	\$3,706	S3	93.6	62.0/31.0	440	26.34	
30	1800	230/460	286T	U1874	286TTT	✓	20:1	\$4,311	S3	94.1	73.0/36.5	503	27.84	
40	1800	230/460	324T	U1875	324TTT	✓	20:1	\$5,725	S3	94.1	95.0/47.5	567	30.37	
50	1800	230/460	326T	U1876	326TTT	✓	20:1	\$7,035	S3	94.5	120/60.0	644	30.37	
60	1800	230/460	364T	U1877	364TTT	✓	20:1	\$9,281	S3	95.0	138/69.0	1078	31.50	
75	1800	230/460	365T	U1878	365TTT	✓	20:1	\$11,766	S3	95.4	172/86.0	1169	32.50	
100	1800	230/460	405T	U1879	405TTT	✓	20:1	\$14,536	S3	95.4	226/113	1458	37.12	
125	1800	460	444T	U1880	444TTT	✓	20:1	\$19,136	S3	95.4	145	1990	43.35	
150	1800	460	445T	U1881	445TTT	✓	20:1	\$21,666	S3	95.8	172	2343	43.35	
200	1800	460	445T	U1882	445TTT	✓	20:1	\$26,412	S3	96.2	226	2556	43.35	
250	1800	460	445T	U1884	445TTTN	✓	20:1	\$32,020	S3	96.2	285	2409	43.26	

Catalog numbers (Cat No.) highlighted in bold blue have efficiency levels that meet EISA requirements

Blue shaded areas are Cast Iron Frames

Blue Chip® Severe Duty / Automotive Duty NEMA Premium® XRI®

Totally Enclosed, Rigid Base, Three Phase

Applications:

Chemical plants, paper mills, refineries, mines, food processing, foundries, and other severe duty environments where long life and ultra-high efficiency are desired. Guaranteed efficiencies offer an eXtra Return on your Investment when using these premium efficiency motors on high cycle or long run applications.

Features:

☛ **Meets or exceeds NEMA Premium® efficiencies, except where noted NEMA Premium® models are in compliance with EISA2007**

- Bearing Current Protection (BCP), as noted
- Blue Chip® quality, 100% cast iron construction for rigidity and reduced vibration
- Provisions to add stub shaft for an encoder (182T-449T, TEFC only)
- Internal and external epoxy paint
- MAX GUARD® Class F insulation system
- Constant Torque speed range is listed in CT SPEED RANGE column
- 1.15 Service Factor on sinewave, 1.0 Service Factor on IGBT power
- Bearing caps (254T and larger)
- Precision balanced to .08"/sec
- Extended grease tubes, regreasable in service
- Brass drain and breather

- Meets IEEE45 USCG Marine Duty, IP54 Construction
- Meets Ford EM1 Automotive Duty Specification
- **BCP (-P) models are not certified for Hazardous Duty™ Division 2 locations**
- Hazardous Duty™ Division 2 CSA certification nameplate
- Division 2 / Zone 2 Class I (gases), Groups A, B, C, D
- Meets temperature code T2B
- Actual test and vibration data supplied with each motor
- Ball bearings (except as noted)
- UL Recognized (through 449T) and CSA Certified and CE Marked
- Three year warranty



SEVERE DUTY

Models through 40 HP are capable of modification as follows (contact factory to confirm):

- 1.25 Service Factor (sinewave only)
- 50Hz at same HP, 1.0 Service Factor (sinewave only)
- Any nameplate changes are subject to modification charges (see MOD Central section)
- Contact Marathon Motors for optional nameplate markings on 50 HP and larger

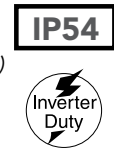

Suitable for use on VFD per guidelines on page 17.

HP	RPM	VOLTS	FRAME	CAT. NO.	MODEL NO.	STOCK	CT SPEED RANGE*	LIST PRICE	MULT. SYMB.	NOM. EFF.	F.L. AMPS	WEIGHT	"C" DIM.	FOOT NOTES	C FACE KITS
3/4	1200	460	143T	E648	143TTTN6576	√	1000:1	\$600	E9	80.0	1.4	53	10.43	75,76,N,NE	A603
	1200	460	143T	E373	143TTFN6576		20:1	\$660	E9	80.0	1.4	53	12.92	75,76,NE	A603
1	1800	460	143T	E649	143TTTN6526	√	1000:1	\$490	E9	85.5	1.5	55	10.43	75,76,N,NE	A603
	1800	460	143T	E374	143TTFN6526		20:1	\$539	E9	85.5	1.5	71	12.92	75,76	A603
	1800	230/460	143T	E461	143TTTN6563	√	1000:1	\$490	E9	85.5	3.1/1.5	55	12.95	75,76,N,NE	A603
	1800	230/460	143T	E375	143TTFN6563		20:1	\$539	E9	85.5	3.1/1.5	71	12.95	75,76	A603
	1800	575	143T	E666	143TTTN6530	√	1000:1	\$490	E9	85.5	1.2	55	10.43	75,76,N,NE	A603
	1800	575	143T	E376	143TTFN16539		20:1	\$539	E9	85.5	1.2	71	14.17	75,76	A603
	1200	460	145T	E650	145TTTN6576	√	1000:1	\$616	E9	80.0	1.65	60	11.43	75,76,N,NE	A655
	1200	230/460	145T	E462	145TTTN6584		1000:1	\$616	E9	80.0	3.3/1.65	60	11.43	75,76,N,NE	A655
1 1/2	3600	460	143T	E651	143TTTN6501	√	1000:1	\$613	E9	86.5	2.0	58	10.43	75,76,N,NE	A603
	3600	460	143T	E377	143TTFN6501		20:1	\$673	E9	85.5	2.0	64	14.17	75,76	A603
	3600	230/460	143T	E463	143TTTN6502		1000:1	\$613	E9	86.5	4.0/2.0	58	10.43	75,76,N,NE	A603
	3600	230/460	143T	E378	143TTFN6502		20:1	\$673	E9	85.5	4.0/2.0	64	14.17	75,76	A603
	3600	575	143T	E851	143TTTN6505		1000:1	\$613	E9	86.5	1.6	58	10.43	75,76,N,NE	A603
	3600	575	143T	E379	143TTFN6505		20:1	\$673	E9	85.5	1.6	64	14.17	75,76	A603
	1800	460	145T	E652	145TTTN6526	√	1000:1	\$531	E9	84.0	2.2	65	11.43	75,76,N,NE	A655
	1800	230/460	145T	E464	145TTTN6834	√	1000:1	\$531	E9	84.0	4.4/2.2	65	11.43	75,76,N,NE	A655
	1800	575	145T	E667	145TTTN6529		1000:1	\$531	E9	84.0	1.8	65	11.43	75,76,N,NE	A655
	1200	460	182T	E632	182TTTS6576	√	1000:1	\$788	E9	87.5	2.2	100	12.71	75,76,N,NE	A644
	1200	460	182T	E380	182TTFS6576		20:1	\$867	E9	87.5	2.2	110	15.19	75	A644
	1200	230/460	182T	E465	182TTTS6578		1000:1	\$788	E9	87.5	4.4/2.2	100	12.71	75,N,NE	A644
2	3600	460	145T	E653	145TTTN6501	√	1000:1	\$642	E9	85.5	2.5	68	11.43	75,76,N,NE	A655
	3600	460	145T	E382	145TTFN6501		20:1	\$707	E9	85.5	2.0	80	14.17	75,76	A655
	3600	230/460	145T	E466	145TTTN6521		1000:1	\$642	E9	85.5	5.0/2.5	68	11.43	75,76,N,NE	A655
	3600	230/460	145T	E383	145TTFN6521		20:1	\$707	E9	85.5	4.0/2.0	80	14.17	75,76	A655
	3600	575	145T	E852	145TTTN6505		1000:1	\$642	E9	85.5	2.0	68	11.43	75,76,N,NE	A655

Catalog numbers (Cat No.) highlighted in bold blue have efficiency levels that meet EISA requirements

Blue shaded areas are Cast Iron Frames

* Requires nameplate modification

Continued on next page.

Blue Chip® Severe Duty / Automotive Duty

NEMA Premium® XRI®

Totally Enclosed, Rigid Base, Three Phase

SEVERE DUTY

HP	RPM	VOLTS	FRAME	CAT. NO.	MODEL NO.	STOCK	CT SPEED RANGE*	LIST PRICE	MULT. SYMB.	NOM. EFF.	F.L. AMPS	WEIGHT	"C" DIM.	FOOT NOTES	C FACE KITS	
2	1800	460	145T	E654	145TTTN6527	✓	1000:1	\$584	E9	85.5	3.0	68	11.43	75,76,N,NE	A655	
	1800	230/460	145T	E467	145TTTN6835	✓	1000:1	\$584	E9	85.5	6.0/3.0	68	11.43	75,76,N,NE	A655	
	1800	230/460	145T	E386	145TTFN6835		20:1	\$642	E9	86.5	5.6/2.8	68	14.17	75,76	A655	
	1800	575	145T	E668	145TTTN6530		1000:1	\$584	E9	85.5	2.4	68	11.43	75,76,N,NE	A655	
	1200	460	184T	E633	184TTTS6576	✓	1000:1	\$974	E9	88.5	3.0	112	13.71	75,N,NE	A644	
	1200	460	184T	E388	184TTFS6576		20:1	\$1,071	E9	88.5	2.9	110	16.19	75	A644	
	1200	230/460	184T	E468	184TTTS6582	✓	1000:1	\$974	E9	88.5	6.0/3.0	112	13.71	75,N,NE	A644	
	3	3600	460	182T	E601	182TTTS6501	✓	1000:1	\$882	E9	87.5	3.8	98	12.71	75,N,NE	A644
3600		230/460	182T	E390	182TTFS6501		20:1	\$971	E9	87.5	3.8	105	15.19	75	A644	
3600		575	182T	E853	182TTTS6505		1000:1	\$882	E9	87.5	3.0	105	12.71	75,N,NE	A644	
3600		575	182T	E392	182TTFS6505		20:1	\$971	E9	87.5	3.0	105	21.57	75	A644	
1800		460	182T	E616	182TTTS6526	✓	1000:1	\$791	E9	90.2	4.0	102	12.71	75,N,NE	A644	
1800		230/460	182T	E470	182TTTS6538	✓	1000:1	\$791	E9	90.2	8.0/4.0	102	12.71	75,N,NE	A644	
1800		575	182T	E669	182TTTS6530	✓	1000:1	\$791	E9	90.2	3.2	102	12.71	75,N,NE	A644	
1200		460	213T	E634	213TTFS6576	✓	20:1	\$1,199	E9	89.5	4.4	176	18.22	75	A206	
1200		230/460	213T	E471	213TTFS6594	✓	20:1	\$1,199	E9	89.5	8.8/4.4	176	18.22	75	A206	
5		3600	460	184T	E602	184TTFS6501	✓	2:1	\$980	E9	89.5	5.9	142	16.19	75	A644
		3600	230/460	184T	E472	184TTFS6810	✓	2:1	\$980	E9	89.5	11.8/5.9	142	16.19	75	A644
		3600	575	184T	E655	184TTFS6505	✓	20:1	\$980	E9	89.5	4.7	142	16.19	75	A644
	1800	460	184T	E617	184TTFS6526	✓	20:1	\$917	E9	90.2	6.2	130	16.19	75	A644	
	1800	230/460	184T	E473	184TTFS6844	✓	20:1	\$917	E9	90.2	12.4/6.2	130	16.19	75	A644	
	1800	575	184T	E670	184TTFS6530	✓	20:1	\$917	E9	90.2	5.0	130	16.19	75	A644	
	1200	460	215T	E635	215TTFS6576	✓	20:1	\$1,473	E9	89.5	6.9	202	19.72	75	A206	
	1200	230/460	215T	E474	215TTFS6881	✓	20:1	\$1,473	E9	89.5	13.8/6.9	202	19.72	75	A206	
	1200	575	215T	E683	215TTFS6580		20:1	\$1,473	E9	89.5	5.5	202	19.72	75	A206	
	7 1/2	3600	460	213T	E603	213TTTS6501	✓	1000:1	\$1,184	E9	91.7	8.9	200	17.19	75,N,NE	A206
		3600	460	213T	E396	213TTFS6501		2:1	\$1,303	E9	89.5	8.9	175	19.72	75	A206
		3600	230/460	213T	E475	213TTTS6502	✓	1000:1	\$1,184	E9	91.7	17.8/8.9	200	17.19	75,N,NE	A206
3600		575	213T	E656	213TTTS6505	✓	1000:1	\$1,184	E9	91.7	7.1	200	17.19	75,N,NE	A206	
1800		460	213T	E618	213TTFS6526	✓	20:1	\$1,124	E9	91.7	9.6	200	19.72	75	A206	
1800		230/460	213T	E476	213TTFS6531	✓	20:1	\$1,124	E9	91.7	19.2/9.6	200	19.72	75	A206	
1800		575	213T	E671	213TTFS6530	✓	20:1	\$1,124	E9	91.7	7.7	200	19.72	75	A206	
1200		460	254T	E636	254TTFNA6576	✓	20:1	\$1,909	E9	91.0	9.9	326	23.52	75	A284	
1200		230/460	254T	E477	254TTFNA6590	✓	20:1	\$1,909	E9	91.0	19.8/9.9	326	23.52	75	A284	
1200		575	254T	E684	254TTFNA6578		20:1	\$1,909	E9	91.0	7.9	326	23.52	75	A284	
10		3600	460	215T	E604	215TTFS6501	✓	2:1	\$1,382	E9	91.7	11.8	218	19.72	75	A206
		3600	230/460	215T	E478	215TTFS6807	✓	2:1	\$1,382	E9	91.7	23.6/11.8	218	19.72	75	A206
	3600	575	215T	E657	215TTFS6505		2:1	\$1,382	E9	91.7	9.5	218	19.72	75	A206	
	1800	460	215T	E619	215TTFS6526	✓	20:1	\$1,353	E9	91.7	12.5	225	19.72	75	A206	
	1800	230/460	215T	E479	215TTFS6527	✓	20:1	\$1,353	E9	91.7	25.0/12.5	225	19.72	75	A206	
	1800	575	215T	E672	215TTFS6530	✓	20:1	\$1,353	E9	91.7	10.0	225	19.72	75	A206	
	1200	460	256T	E637	256TTFNA6576	✓	20:1	\$2,333	E9	91.0	13.1	405	25.27	75	A284	
	1200	230/460	256T	E480	256TTFNA6596	✓	20:1	\$2,333	E9	91.0	26.2/13.1	405	25.27	75	A284	
	1200	575	256T	E685	256TTFNA6578		20:1	\$2,333	E9	91.0	10.5	405	25.27	75	A284	
	15	3600	460	254T	E605	254TTFNA6501	✓	2:1	\$1,852	E9	91.7	17.5	345	23.52	75	A284
		3600	230/460	254T	E481	254TTFNA6515	✓	2:1	\$1,852	E9	91.7	35.0/17.5	345	23.52	75	A284
		3600	575	254T	E658	254TTFNA6503		2:1	\$1,852	E9	91.7	14.2	345	23.52	75	A284
1800		460	254T	E620	254TTFNA6526	✓	20:1	\$1,738	E9	92.4	18.8	350	23.52	75	A284	
1800		460	254T	E620-P	254TTFNA16838	✓	20:1	\$1,912	E9	92.4	18.8	350	23.52	75,P	A284	
1800		230/460	254T	E482	254TTFNA6529	✓	20:1	\$1,738	E9	92.4	37.6/18.8	350	23.52	75	A284	
1800		575	254T	E673	254TTFNA6528	✓	20:1	\$1,738	E9	92.4	15.0	350	23.52	75	A284	
1200		460	284T	E638	284TTFNA6576	✓	20:1	\$3,096	E9	91.7	20.4	479	26.34		A618	
1200		230/460	284T	E483	284TTFNA6876	✓	20:1	\$3,096	E9	91.7	40.8/20.4	479	26.34		A618	
1200		575	284T	E694	284TTFNA6580	✓	20:1	\$3,096	E9	91.7	16.3	479	26.34		A618	

Catalog numbers (Cat No.) highlighted in bold blue have efficiency levels that meet EISA requirements

Blue shaded areas are Cast Iron Frames

* Requires nameplate modification

Continued on next page.

Blue Chip® Severe Duty / Automotive Duty NEMA Premium® XRI®

Totally Enclosed, Rigid Base, Three Phase

HP	RPM	VOLTS	FRAME	CAT. NO.	MODEL NO.	STOCK	CT SPEED RANGE*	LIST PRICE	MULT. SYMB.	NOM. EFF.	F.L. AMPS	WEIGHT	"C" DIM.	FOOT NOTES	C FACE KITS	
20	3600	460	256T	E606	256TTFNA6501	✓	2:1	\$2,294	E9	92.4	23.4	375	25.27	75	A284	
	3600	230/460	256T	E484	256TTFNA6523		2:1	\$2,294	E9	92.4	47.0/23.4	375	25.27	75	A284	
	3600	575	256T	E659	256TTFNA6503	✓	2:1	\$2,294	E9	92.4	18.7	375	25.27	75	A284	
	1800	460	256T	E621	256TTFNA6526	✓	20:1	\$2,166	E9	93.0	24.1	425	25.27	75	A284	
	1800	460	256T	E621-P	256TTFNA16855	✓	20:1	\$2,383	E9	93.0	24.1	425	25.27	75,P	A284	
	1800	230/460	256T	E485	256TTFNA6529	✓	20:1	\$2,166	E9	93.0	48.2/24.1	425	25.27	75	A284	
	1800	575	256T	E674	256TTFNA6528	✓	20:1	\$2,166	E9	93.0	19.3	425	25.27	75	A284	
	1200	460	286T	E639	286TTFNA6576	✓	20:1	\$3,771	E9	91.7	26.8	550	27.84		A618	
	1200	230/460	286T	E486	286TTFNA6876		20:1	\$3,771	E9	91.7	53.5/26.8	550	27.84		A618	
	1200	575	286T	E695	286TTFNA6580		20:1	\$3,771	E9	91.7	21.4	550	27.84		A618	
	25	3600	460	284TS	E607	284TSTFNA6501	✓	2:1	\$2,826	E9	93.6	28.1	481	24.97		A618
		3600	575	284TS	E660	284TSTFNA6502		2:1	\$2,826	E9	93.6	22.5	481	24.97		A618
1800		460	284T	E622	284TTFNA6526	✓	20:1	\$2,579	E9	93.6	31.0	478	26.34		A618	
1800		460	284T	E622-P	284TTFNA16851	✓	20:1	\$2,837	E9	93.6	31.0	478	26.34	P	A618	
1800		230/460	284T	E488	284TTFNA6837	✓	20:1	\$2,579	E9	93.6	62.0/31.0	478	26.34		A618	
1800		575	284T	E675	284TTFNA6527	✓	20:1	\$2,579	E9	93.6	24.8	478	26.34		A618	
1200		460	324T	E640	324TTF6576	✓	20:1	\$4,571	E9	93.0	32.5	675	28.87		A214	
1200		575	324T	E696	324TTF6577		20:1	\$4,571	E9	93.0	26.0	675	28.87		A214	
30		3600	460	286TS	E608	286TSTFNA6501	✓	2:1	\$3,300	E9	93.6	34.1	500	26.47		A618
		3600	230/460	286TS	E490	286TSTFNA6804	✓	2:1	\$3,300	E9	93.6	67.5/34.0	500	26.47		A618
		1800	460	286T	E623	286TTFNA6526	✓	20:1	\$2,999	E9	94.1	36.5	525	27.84		A618
		1800	460	286T	E623-P	286TTFNA16847	✓	20:1	\$3,299	E9	94.1	36.5	525	27.84	P	A618
	1800	230/460	286T	E491	286TTFNA6570	✓	20:1	\$2,999	E9	94.1	73.0/36.5	525	27.84		A618	
	1800	575	286T	E676	286TTFNA6527	✓	20:1	\$2,999	E9	94.1	29.2	525	27.84		A618	
	1200	460	326T	E641	326TTF6576	✓	20:1	\$5,266	E9	93.0	38.5	725	30.37		A214	
	1200	575	326T	E400	326TTF6580		20:1	\$5,266	E9	93.0	31.0	725	30.37		A214	
	40	3600	460	324TS	E609	324TSTFS6501	✓	2:1	\$4,353	E9	93.6	47.0	656	27.37		A214
		3600	575	324TS	E662	324TSTFS6505		2:1	\$4,353	E9	93.6	37.5	656	27.37		A214
		1800	460	324T	E624	324TTF6526	✓	20:1@	\$3,983	E9	94.1	47.5	700	30.37		A214
		1800	460	324T	E624-P	324TTF6526	✓	20:1@	\$4,381	E9	94.1	47.5	700	30.37	P	A214
1800		575	324T	E677	324TTF6527	✓	20:1@	\$3,983	E9	94.1	38.0	700	30.37		A214	
1200		460	364T	E642A	364TTF6584	✓	20:1@	\$7,670	E9	94.1	50.0	882	31.50		A395	
1200		575	364T	E401A	364TTF6585		20:1@	\$7,670	E9	94.1	40.0	882	31.50		A395	
50		3600	460	326TS	E610	326TSTFS6501	✓	2:1	\$5,631	E9	93.6	58.0	725	28.87		A214
		3600	575	326TS	E663	326TSTFS6502		2:1	\$5,631	E9	93.6	46.5	725	28.87		A214
		1800	460	326T	E625	326TTF6526	✓	20:1@	\$4,892	E9	94.5	60.0	775	31.87		A214
		1800	460	326T	E625-P	326TTF6526	✓	20:1@	\$5,381	E9	94.5	60.0	775	31.87	P	A214
		1800	460	326TS	E453	326TSTFS6536		20:1@	\$4,892	E9	94.5	60.0	775	28.87		A214
	1800	575	326T	E678	326TTF6527	✓	20:1@	\$4,892	E9	94.5	48.0	775	30.37		A214	
	1200	460	365T	E643A	365TTF6591	✓	20:1@	\$8,623	E9	94.1	61.5	946	32.50		A395	
	1200	575	365T	E402A	365TTF6592		20:1@	\$8,623	E9	94.1	49.0	946	32.50		A395	
	60	3600	460	364TS	E611	364TSTFS6501	✓	2:1	\$7,407	E9	94.5	67.0	954	29.38		A396
		3600	575	364TS	E664	364TSTFS6505		2:1	\$7,407	E9	94.5	53.5	954	29.38		A396
		1800	460	364T	E626	364TTF6536	✓	20:1@	\$7,018	E9	95.0	69.0	980	31.50		A395
		1800	460	364TS	E454	364TSTFS6526		20:1@	\$7,018	E9	95.0	69.0	980	29.38		A396
1800		575	364T	E679	364TTF6537	✓	20:1@	\$7,018	E9	95.0	55.0	980	31.50		A395	
1200		460	404T	E644	404TTF6586	✓	20:1@	\$9,602	E9	94.5	72.0	1156	35.62		A223	
1200		575	404T	E403	404TTF6592		20:1@	\$9,602	E9	94.5	57.5	1156	35.62		A223	
75		3600	460	365TS	E612	365TSTFS6501	✓	2:1	\$9,302	E9	94.5	84.0	1002	30.38		A396
		3600	575	365TS	E665	365TSTFS6502	✓	2:1	\$9,302	E9	94.5	67.0	1002	30.38		A396
		1800	460	365T	E627	365TTF6536	✓	20:1@	\$8,896	E9	95.4	86.0	1100	32.50		A395
		1800	460	365TS	E455	365TSTFS6526	✓	20:1@	\$8,896	E9	95.4	86.0	1100	30.38		A396
		1800	575	365T	E680	365TTF6537	✓	20:1@	\$8,896	E9	95.4	69.0	1100	32.50		A395
	1200	460	405T	E645	405TTF6586	✓	20:1@	\$11,304	E9	94.5	90.0	1280	37.12		A223	
	1200	575	405T	E404	405TTF6587		20:1@	\$11,304	E9	94.5	71.5	1280	37.12		A223	

Catalog numbers (Cat No.) highlighted in bold blue have efficiency levels that meet EISA requirements

Blue shaded areas are Cast Iron Frames

* Requires nameplate modification
@ Requires larger fan

Continued on next page.

Blue Chip® Severe Duty / Automotive Duty NEMA Premium® XRI®

Totally Enclosed, Rigid Base, Three Phase

SEVERE DUTY

HP	RPM	VOLTS	FRAME	CAT. NO.	MODEL NO.	STOCK	CT SPEED RANGE*	LIST PRICE	MULT. SYMB.	NOM. EFF.	F.L. AMPS	WEIGHT	"C" DIM.	FOOT NOTES	C FACE KITS	
100	3600	460	405TS	E613	405TSTFS6501	✓	2:1	\$12,465	E9	95.0	108	1295	34.12		A226	
	3600	575	405TS	E493	405TSTFS6502		2:1	\$12,465	E9	95.0	87.0	1295	34.12		A226	
	1800	460	405T	E628	405TTFS6536	✓	20:1@	\$10,991	E9	95.4	113	1330	37.12		A223	
	1800	460	405TS	E456	405TSTFS6526	✓	20:1@	\$10,991	E9	95.4	113	1330	34.12		A226	
	1800	575	405T	E681	405TTFS6538	✓	20:1@	\$10,991	E9	95.4	90.5	1330	37.12		A223	
	1200	460	444T	E327	444TTFN16577		20:1@	\$16,975	E9	95.0	124	1970	41.34		A620	
	1200	460	444T	E646A	444TTFN16581	✓	20:1@	\$16,975	E9	95.0	124	1806	43.35		A620	
	1200	575	444T	E405A	444TTFS16582		20:1@	\$16,975	E9	95.0	94.5	1690	41.25		A229	
125	3600	460	444TS	E614	444TSTFS6501	✓	2:1	\$16,295	E9	95.4	136	1725	37.50		A232	
	3600	575	444TS	E494	444TSTFS6505		2:1	\$16,295	E9	95.4	109	1725	37.50		A232	
	1800	460	444T	E629	444TTFS6536	✓	20:1@	\$14,469	E9	95.4	141	1725	41.25		A229	
	1800	460	444TS	E457	444TSTFS6526	✓	20:1@	\$14,469	E9	95.4	141	1725	37.50		A232	
	1800	575	444T	E697	444TTFS6540		20:1@	\$14,469	E9	95.4	113	1725	41.25		A229	
	1200	460	445T	E647	445TTFN6586	✓	20:1@	\$18,975	E9	95.0	155	2000	43.26		A620	
	1200	575	445T	E406	445TTFN6590		20:1@	\$18,975	E9	95.0	124	2000	43.26		A620	
	150	3600	460	445TS	E615	445TSTFN6501	✓	2:1	\$19,574	E9	95.8	165	2187	39.44		A621
3600		575	445TS	E495	445TSTFN6502		2:1	\$19,574	E9	95.8	132	2187	39.44		A621	
1800		460	445T	E630	445TTFN6536	✓	20:1@	\$16,822	E9	95.8	172	2070	43.26		A620	
1800		460	445TS	E458	445TSTFN6526	✓	20:1@	\$16,822	E9	95.8	172	2070	39.44		A621	
1800		575	445T	E682	445TTFN6537		20:1@	\$16,822	E9	95.8	138	2070	43.26		A620	
1200		460	445T	E448	445TTFN6587	✓	20:1@	\$21,229	E9	95.8	180	2500	43.26	H, RB	N/A	
1200		575	445T	E407	445TTFN6591		20:1@	\$21,229	E9	95.8	145	2500	43.26	RB	N/A	
200		3600	460	445TS	E449	445TSTFN6505	✓	2:1	\$24,762	E9	95.8	222	2300	39.44	H	A621
	3600	575	445TS	E496	445TSTFN6506		2:1	\$24,762	E9	95.8	178	2300	39.44		A621	
	1800	460	445T	E631	445TTFN6538	✓	20:1@	\$20,459	E9	96.2	226	2437	43.26	RB	N/A	
	1800	460	445TS	E459	445TSTFN6528	✓	20:1@	\$20,459	E9	96.2	226	2437	39.44	H	A621	
	1800	460	447/9T	E770	449TTFS6530	✓	20:1@	\$23,528	E9	96.5	225	2700	51.69	H	A623	
	1800	460	447/9T	E854	449TTFS6540	✓	20:1@	\$23,528	E9	96.5	225	2700	51.69	H, RB, d	N/A	
	1800	575	447/9T	E856	449TTFS6564		20:1@	\$23,528	E9	96.5	180	2700	51.69	H, RB	N/A	
	1200	460	447/9T	E773	449TTFS6578	✓	20:1@	\$25,988	E9	95.8	240	2927	51.69	H	A623	
	1200	460	447/9T	E687	449TTFS6588	✓	20:1@	\$25,988	E9	95.8	240	2927	51.69	H, RB	N/A	
	1200	575	447/9T	E408	449TTFS6582		20:1@	\$25,988	E9	95.8	192	2927	51.69	H, RB	N/A	
	250	3600	460	447/9TS	E699	449TSTFS6503	✓	2:1	\$31,230	E9	95.8	275	2700	47.88	H, NE	A624
		1800	460	445T	E450	445TTFN6540		20:1@	\$25,668	E9	95.8	285	2450	43.26	H, NE, RB	N/A
1800		460	447/9T	E771	449TTFS6528	✓	20:1@	\$29,517	E9	96.5	285	2830	51.69	H, NE	A623	
1800		460	447/9T	E690	449TTFS6538	✓	20:1@	\$29,517	E9	96.5	285	2830	51.69	H, NE, RB	N/A	
1200		460	L447/9T	E774	449TTFS6577		20:1@	\$29,874	E9	95.8	300	3415	51.69	H, NE	A623	
1200		460	L447/9T	E688	449TTFS6587		20:1@	\$29,874	E9	95.8	300	3415	51.69	H, NE, RB	N/A	
300		3600	460	447/9TS	E698	449TSTFS6502	✓	2:1	\$40,479	E9	96.2	330	2700	47.88	H, NE	A624
		1800	460	447/9T	E691	449TTFS6537	✓	20:1@	\$32,767	E9	96.5	339	3211	51.69	H, NE, RB	N/A
	1800	460	447/9T	E772	449TTFS6527	✓	20:1@	\$32,767	E9	96.5	339	3211	51.69	H, NE	A623	
	1800	575	447/9T	E345	449TTFS16534		20:1@	\$32,767	E9	96.5	271	3211	51.69	H, NE, RB	N/A	
	350	3600	460	447/9TS	E769	449TSTFS6501	✓	2:1	\$46,420	E9	95.8	380	3064	47.88	H, NE	A624
1800		460	447/9T	E692	449TTFS6536	✓	20:1@	\$38,274	E9	96.2	395	3350	51.69	H, NE, RB	N/A	
400	3600	460	5011S	E369	---		N/A	\$55,099	S6	95.8	432	5500	67.19	NE, 90	N/A	
	1800	460	L447/9T	E776	449TTFS16553		2:1	\$39,295	E9	96.2	448	3800	56.71	H, NE, 79	N/A	
	1200	460	5011LS	E362	---		N/A	\$68,918	S6	95.8	468	5500	67.19	NE, 77, 79, 90	N/A	
450	1800	460	L447/9T	E777	---		N/A	\$40,177	E9	96.5	515	3800	56.71	H, NE, 79	N/A	
	1200	460	5013LS	E363	5013LSTFS6595		N/A	\$91,917	S6	96.2	525	7200	67.19	A, NE, 77, 79, 90	N/A	
500	1800	460	5011LS	E364	5011LSTFS16031		N/A	\$63,352	S6	96.2	555	5500	67.19	NE, 77, 79, 90	N/A	
	1200	460	5013LS	E365	---		N/A	\$93,219	S6	96.2	580	7200	76.19	NE, 78, 79, 90	N/A	
600	1800	460	5011LS	E366	5011LSTFS16033		N/A	\$75,063	S6	96.2	655	5500	67.19	A, NE, 77, 79, 90	N/A	

Catalog numbers (Cat No.) highlighted in bold blue have efficiency levels that meet EISA requirements

Blue shaded areas are Cast Iron Frames

* Requires nameplate modification
@ Requires larger fan

Blue Chip® Severe Duty / Automotive Duty NEMA Premium® XRI® IEEE-841 Totally Enclosed, Rigid Base, Three Phase



Applications:

For extreme applications in the process industries such as chemical plants, pulp and paper mills, refineries, above-ground mines, food processing, foundries, and other severe duty environments where long life and ultra-high efficiency are required. Guaranteed efficiencies offer an eXtra Return on your Investment when using these premium efficiency motors on high cycle or long run time applications.

Features:

- Meets or exceeds NEMA Premium® efficiencies, except where noted
- NEMA Premium® models are in compliance with EISA2007
- Meets IEEE-841 standard for severe duty applications
- Bearing Current Protection (BCP), as noted
- Blue Chip® quality, 100% cast iron construction for rigidity and reduced vibration
- Inpro/Seal® VBX® bearing isolators on drive end shaft extension TENV and on both ends of TEFC
- Provisions to add stub shaft for an encoder (182T-449T, TEFC only)
- Internal and external epoxy paint
- MAX GUARD® Class F insulation system
- Constant Torque speed range is listed in CT SPEED RANGE column
- 1.15 Service Factor on sinewave, 1.0 Service Factor on IGBT power
- Bearing caps (254T and larger)
- Precision balanced to .08"/sec
- Extended grease tubes, regreasable in service
- Brass drain and breather
- Meets General Motors GM 7E-TA Automotive Duty Specification
- Meets IEEE45 USCG Marine Duty, API RPI4F for offshore platforms, IP56
- Meets NEMA MG1 - 1.26.6 Waterproof specification
- **BCP (-P) models are not certified for Hazardous Duty™ Division 2 locations**
- Hazardous Duty™ Division 2 CSA certification nameplate
- Division 2 / Zone 2 Class I (gases), Groups A, B, C, D
- Meets temperature code T2B
- Actual test and vibration data supplied with each motor
- Ball bearings (except as noted)
- UL Recognized (through 449T) and CSA Certified and CE Marked
- Five year warranty

Models through 40 HP are capable of modification as follows (contact factory to confirm):

- 1.25 Service Factor (sinewave only)
- 50HZ at same HP, 1.0 Service Factor (sinewave only)
- Any nameplate changes are subject to modification charges (see MOD Central Section)
- Contact Marathon Motors for optional nameplate markings on 50 HP and larger



Suitable for use on VFD per guidelines on page 17.

HP	RPM	VOLTS	FRAME	CAT. NO.	MODEL NO.	STOCK	CT SPEED RANGE*	LIST PRICE	MULT. SYMB.	NOM. EFF.	F.L. AMPS	WEIGHT	"C" DIM.	FOOT NOTES	C FACE KITS
1	1800	460	143T	W501	143THTN9026	✓	1000:1	\$661	E9	85.5	1.5	55	10.43	75,76,N,NE	A181
	1800	575	143T	W502	143THTN19033		1000:1	\$661	E9	85.5	1.2	55	10.43	75,76,N,NE	A181
	1200	460	145T	W503	145THTN9076		1000:1	\$832	E9	80.0	1.65	60	11.43	75,76,N,NE	A262
	1200	575	145T	W638	145THTN19079		1000:1	\$832	E9	80.0	1.3	60	11.43	75,76,N,NE	A262
	900	460	182T	W504	182THFS19101		20:1	\$1,461	E9	74.0	2.2	81	15.19	75,NE	A182
1 1/2	3600	460	143T	W505	143THTN9001		1000:1	\$827	E9	86.5	2.0	58	10.43	75,76,N,NE	A181
	3600	575	143T	W506	143THTN9005		1000:1	\$827	E9	86.5	1.6	58	10.43	75,76,N,NE	A181
	1800	460	145T	W507	145THTN9026	✓	1000:1	\$716	E9	84.0	2.2	65	11.43	75,76,N,NE	A262
	1800	575	145T	W508	145THTN19045		1000:1	\$716	E9	84.0	1.75	65	11.43	75,76,N,NE	A262
	1200	460	182T	W509	182THTS9076		1000:1	\$1,065	E9	87.5	2.2	100	12.71	75,N,NE	A182
2	3600	460	145T	W511	145THTN9001		1000:1	\$867	E9	85.5	2.5	68	11.43	75,76,N,NE	A262
	3600	575	145T	W512	145THTN19002		1000:1	\$867	E9	85.5	2.0	68	11.43	75,76,N,NE	A262
	1800	460	145T	W513	145THTN9027	✓	1000:1	\$787	E9	85.5	3.0	68	11.43	75,76,N,NE	A262
	1800	575	145T	W514	145THTN19033		1000:1	\$787	E9	85.5	2.4	68	11.43	75,76,N,NE	A262
	1200	460	184T	W515	184THTS9076		1000:1	\$1,315	E9	88.5	3.0	112	13.71	75,N,NE	A182

Catalog numbers (Cat No.) highlighted in bold blue have efficiency levels that meet EISA requirements

Blue shaded areas are Cast Iron Frames

* Requires nameplate modification

Continued on next page.

Blue Chip® Severe Duty / Automotive Duty

NEMA Premium® XRI® IEEE-841

Totally Enclosed, Rigid Base, Three Phase

SEVERE DUTY

HP	RPM	VOLTS	FRAME	CAT. NO.	MODEL NO.	STOCK	CT SPEED RANGE*	LIST PRICE	MULT. SYMB.	NOM. EFF.	F.L AMPS	WEIGHT	"C" DIM.	FOOT NOTES	C FACE KITS	
3	3600	460	182T	W517	182THTS9001		1000:1	\$1,191	E9	87.5	3.8	105	12.71	75,N,NE	A182	
	1800	460	182T	W519	182THTS9026	✓	1000:1	\$1,068	E9	90.2	4.0	100	12.71	75,N,NE	A182	
	1800	575	182T	W520	182THTS19033		1000:1	\$1,068	E9	90.2	3.2	100	12.71	75,N,NE	A182	
	1200	460	213T	W521	213THFS9076	✓	20:1	\$1,620	E9	89.5	4.4	176	18.22	75	A183	
	900	460	215T	W522	215THFS9101		20:1	\$2,426	E9	86.5	5.0	180	19.72	75,NE	A183	
5	3600	460	184T	W523	184THFS9001	✓	2:1	\$1,323	E9	89.5	5.9	142	16.19	75	A182	
	3600	575	184T	W524	184THFS19006		2:1	\$1,323	E9	89.5	4.7	142	16.19	75	A182	
	1800	460	184T	W525	184THFS9026	✓	20:1	\$1,238	E9	90.2	6.2	130	16.19	75	A182	
	1800	575	184T	W526	184THFS9030	✓	20:1	\$1,238	E9	90.2	5.0	130	16.19	75	A182	
	1200	460	215T	W527	215THFS9076	✓	20:1	\$1,988	E9	89.5	6.9	202	19.72	75	A183	
	1200	575	215T	W528	215THFS19077		20:1	\$1,988	E9	89.5	5.5	202	19.72	75	A183	
	900	460	254T	W529	254THFNA9101		10:1	\$3,162	E9	88.5	7.5	375	23.52	75,NE	A184	
	7 1/2	3600	460	213T	W530	213THTS9001	✓	2:1	\$1,598	E9	91.7	8.9	200	17.18	75,N	A183
7 1/2	3600	575	213T	W531	213THTS19005		2:1	\$1,598	E9	91.7	7.1	200	17.18	75,N	A183	
	1800	460	213T	W532	213THFS9026	✓	20:1	\$1,517	E9	91.7	9.6	200	19.73	75	A183	
	1800	575	213T	W533	213THFS9030	✓	20:1	\$1,517	E9	91.7	7.7	200	19.72	75	A183	
	1200	460	254T	W534	254THFNA9076	✓	20:1	\$2,387	E9	91.0	9.9	326	23.52	75	A184	
	900	460	256T	W536	256THFNA9101		20:1	\$3,921	E9	88.5	11.0	425	25.27	75,NE	A184	
	10	3600	460	215T	W537	215THFS9001	✓	2:1	\$1,866	E9	91.7	11.9	218	19.72	75	A183
		3600	575	215T	W538	215THFS19006		2:1	\$1,866	E9	91.7	9.5	218	19.72	75	A183
		1800	460	215T	W539	215THFS9026	✓	20:1	\$1,827	E9	91.7	12.5	225	19.72	75	A183
1800		575	215T	W540	215THFS19033	✓	20:1	\$1,827	E9	91.7	10.0	225	19.73	75	A183	
1200		460	256T	W541	256THFNA9076	✓	20:1	\$2,915	E9	91.0	13.1	405	25.27	75	A184	
1200		575	256T	W542	256THFNA19081		20:1	\$2,915	E9	91.0	10.5	405	25.27	75	A184	
900		460	284T	W543	284THFNA19102		20:1	\$4,767	E9	90.2	16.0	550	27.88	NE	A186	
15		3600	460	254T	W544	254THFNA9001	✓	20:1	\$2,314	E9	91.7	17.5	345	23.52		A184
	1800	460	254T	W546	254THFNA9026	✓	20:1	\$2,173	E9	92.4	18.8	350	23.52		A184	
	1800	460	254T	W546-P	254THFNA19065	✓	20:1	\$2,499	E9	92.4	18.8	350	23.52	P	A184	
	1800	575	254T	W547	254THFNA9030	✓	20:1	\$2,173	E9	92.4	15.1	350	23.52		A184	
	1200	460	284T	W548	284THFNA9076	✓	20:1	\$3,870	E9	91.7	20.4	479	27.88		A186	
	1200	575	284T	W549	284THFNA19084		20:1	\$3,870	E9	91.7	16.3	479	26.34		A186	
	900	460	286T	W550	286THFNA19101	✓	20:1	\$5,980	E9	90.2	22.0	575	27.84	NE	A186	
	20	3600	460	256T	W551	256THFNA9001	✓	2:1	\$2,868	E9	92.4	23.4	375	25.27	75	A184
1800		460	256T	W553	256THFNA9026	✓	20:1	\$2,708	E9	93.0	24.1	425	25.27	75	A184	
1800		460	256T	W553-P	256THFNA19056	✓	20:1	\$3,114	E9	93.0	24.1	425	25.27	75,P	A184	
1800		575	256T	W554	256THFNA19033	✓	20:1	\$2,708	E9	93.0	19.3	425	25.27	75	A184	
1200		460	286T	W555	286THFNA9076	✓	20:1	\$4,714	E9	91.7	26.8	550	27.84		A186	
1200		575	286T	W556	286THFNA19077		20:1	\$4,714	E9	91.7	21.4	550	27.84		A186	
25		3600	460	284TS	W558	284TSHFNA9001	✓	2:1	\$3,533	E9	93.6	28.1	481	24.97		A186
	3600	575	284TS	W559	284TSHFNA9005		2:1	\$3,533	E9	93.6	22.4	481	24.97		A186	
	1800	460	284T	W560	284THFNA9026	✓	20:1	\$3,223	E9	93.6	31.0	478	26.44		A186	
	1800	460	284T	W560-P	284THFNA19048	✓	20:1	\$3,706	E9	93.6	31.0	478	26.44	P	A186	
	1800	575	284T	W561	284THFNA19033	✓	20:1	\$3,223	E9	93.6	24.8	478	26.34		A186	
	1200	460	324T	W562	324THFS9076	✓	20:1	\$5,715	E9	93.0	32.5	675	28.87		A187	
	1200	575	324T	W563	324THFS9080		20:1	\$5,715	E9	93.0	26.0	675	28.87		A187	
	30	3600	460	286TS	W565	286TSHFNA9001	✓	2:1	\$4,126	E9	93.6	33.8	500	26.44		A186
1800		460	286T	W567	286THFNA9026	✓	20:1	\$3,749	E9	94.1	36.5	525	27.84		A186	
1800		460	286T	W567-P	286THFNA19066	✓	20:1	\$4,311	E9	94.1	36.5	525	27.84	P	A186	
1800		575	286T	W568	286THFNA19033		20:1	\$3,749	E9	94.1	29.2	525	27.84		A186	
1200		460	326T	W569	326THFS9076	✓	20:1@	\$6,582	E9	93.0	38.5	725	30.37		A187	
1200		575	326T	W643	326THFS19078		20:1@	\$6,582	E9	93.0	31.0	725	30.37		A187	

Catalog numbers (Cat No.) highlighted in bold blue have efficiency levels that meet EISA requirements

Blue shaded areas are Cast Iron Frames

* Requires nameplate modification
@ Requires larger fan

Continued on next page.

Blue Chip® Severe Duty / Automotive Duty NEMA Premium® XRI® IEEE-841 Totally Enclosed, Rigid Base, Three Phase

HP	RPM	VOLTS	FRAME	CAT. NO.	MODEL NO.	STOCK	CT SPEED RANGE*	LIST PRICE	MULT. SYMB.	NOM. EFF.	F.L. AMPS	WEIGHT	"C" DIM.	FOOT NOTES	C FACE KITS
40	3600	460	324TS	W571	324TSHFS9001	✓	2:1	\$5,441	E9	93.6	47.0	656	27.37		A187
	1800	460	324T	W573	324THFS9026	✓	20:1@	\$4,978	E9	94.1	47.5	700	28.87		A187
	1800	460	324T	W573-P	324THFS19058	✓	20:1@	\$5,725	E9	94.1	47.5	700	28.87	P	A187
	1800	575	324T	W574	324THFS19033		20:1@	\$4,978	E9	94.1	38.0	700	30.37		A187
	1200	460	364T	W575A	364THFS19087	✓	20:1@	\$8,207	E9	94.1	50.0	950	31.50		A188
	1200	575	364T	W639	364THFS19077		20:1@	\$8,207	E9	94.1	40.0	950	31.50		A188
	900	460	365T	W576	365THFS19101		20:1@	\$11,701	E9	91.7	53.0	975	32.50	NE	A188
50	3600	460	326TS	W577	326TSHFS9001	✓	2:1	\$7,038	E9	93.6	58.0	725	28.87		A187
	3600	575	326TS	W578	326TSHFS9005		2:1	\$7,038	E9	93.6	46.5	725	28.87		A187
	1800	460	326T	W580	326THFS9026	✓	2:1	\$6,115	E9	94.5	60.0	775	30.37		A187
	1800	460	326T	W580-P	326THFS19071	✓	20:1@	\$7,032	E9	94.5	60.0	775	30.37	P	A187
	1800	460	326TS	W579	326TSHFS9036		2:1	\$6,115	E9	94.5	60.0	775	28.87		A187
	1800	575	326T	W581	326THFS19033		2:1	\$6,115	E9	94.5	48.0	775	30.37		A187
	1200	460	365T	W582A	365THFS19086	✓	20:1@	\$10,066	E9	94.5	61.5	942	32.50		A188
	1200	575	365T	W640	365THFS19077		20:1@	\$10,166	E9	94.5	49.0	983	31.50		A188
	900	460	404T	W583	404THFS9101		20:1@	\$13,166	E9	93.6	66.0	1264	35.62	NE	A190
60	3600	460	364TS	W584	364TSHFS9001	✓	2:1	\$8,519	E9	94.5	67.0	925	29.38		A189
	1800	460	364T	W587	364THFS9036	✓	20:1@	\$8,070	E9	95.0	69.0	1000	31.50		A188
	1800	460	364T	W587-P	364THFS19061	✓	20:1@	\$8,716	E9	95.0	69.0	1000	31.50	P	A188
	1800	460	364TS	W586	364TSHFS9026		20:1@	\$8,070	E9	95.0	69.0	1000	29.38		A189
	1800	575	364T	W588	364THFS19033		20:1@	\$8,070	E9	95.0	55.0	1000	31.50		A188
	1200	460	404T	W589	404THFS9086		20:1@	\$11,043	E9	94.5	72.0	1156	35.62		A190
	900	460	405T	W590	405THFS19101		20:1@	\$14,773	E9	93.6	80.0	1350	37.12	NE	A190
75	3600	460	365TS	W591	365TSHFS9001	✓	2:1	\$10,697	E9	94.5	84.0	1002	30.38		A189
	3600	575	365TS	W592	365TSHFS19002		2:1	\$10,697	E9	94.5	67.0	1002	30.38		A189
	1800	460	365T	W594	365THFS9036	✓	20:1@	\$10,231	E9	95.4	86.0	1100	32.50		A188
	1800	460	365T	W594-P	365THFS19065	✓	20:1@	\$11,147	E9	95.4	86.0	1100	32.50	P	A188
	1800	460	365TS	W593A	365TSHFS19034		20:1@	\$10,231	E9	95.4	86.0	1100	30.38		A189
	1800	575	365T	W595	365THFS9044		20:1@	\$10,231	E9	95.4	69.0	1100	32.50		A188
	1200	460	405T	W596	405THFS9086		20:1@	\$12,998	E9	95.0	90.0	1280	37.12		A190
	900	460	444T	W597	444THFS9101		20:1@	\$19,643	E9	93.6	100	1734	41.25	NE	A192
	100	3600	460	405TS	W598	405TSHFS9001	✓	2:1	\$14,334	E9	95.0	108	1295	34.12	
1800		460	405T	W600	405THFS9036	✓	20:1@	\$12,640	E9	95.4	113	1330	37.12		A190
1800		460	405T	W600-P	405THFS19327	✓	20:1@	\$13,651	E9	95.4	113	1330	37.12	P	A190
1800		460	405TS	W599	405TSHFS9026		20:1@	\$12,640	E9	95.4	113	1330	34.12		A191
1800		575	405T	W601	405THFS9040	✓	20:1@	\$12,640	E9	95.4	90.0	1330	37.12	d	A190
1200		460	444T	W636	444THFN19081		20:1@	\$19,168	E9	95.0	124	2100	41.25		A194
900		460	445T	W603	445THFN9106		20:1@	\$24,072	E9	94.1	142	2350	43.19	NE	A194
125	3600	460	444TS	W604A	444TSHFN19002		2:1	\$18,740	E9	95.0	142	1682	39.64		A193
	1800	460	444T	W606	444THFS9036	✓	20:1@	\$16,640	E9	95.4	141	1725	41.25		A192
	1800	460	444T	W606-P	444THFN19044	✓	20:1@	\$17,971	E9	95.4	141	1725	41.25	P	A194
	1800	575	444T	W607	444THFS9040	✓	20:1@	\$16,640	E9	95.4	113	1725	41.25		A192
	1200	460	445T	W608	445THFN9086		20:1@	\$21,820	E9	95.0	155	2000	43.19		A194
	900	460	445T	W609	445THFN9102		20:1@	\$24,724	E9	94.5	172	2515	43.19	NE	A194
150	3600	460	445TS	W610	445TSHFN9001		2:1	\$22,511	E9	95.8	165	2187	39.37		A195
	1800	575	445TS	W611	445TSHFN9026		20:1@	\$19,345	E9	95.8	172	2070	39.37		A195
	1800	460	445T	W612	445THFN9036	✓	20:1@	\$19,345	E9	95.8	172	2070	43.19		A194
	1800	460	445T	W612-P	445THFN19071	✓	20:1@	\$20,892	E9	95.8	172	2070	43.19	P	A194
	1800	575	445T	W641	445THFN19033		20:1@	\$19,345	E9	95.8	138	2070	43.19	RB	A194
	1800	575	445T	W613	445THFN9037		20:1@	\$19,345	E9	95.8	138	2070	43.19		A194
	1200	460	445T	W614	445THFN9087		20:1@	\$24,415	E9	95.8	181	2500	43.19	H, RB	A194
	900	460	L447/9T	W615	449THFS9101		20:1@	\$31,445	E9	95.4	205	3150	51.88	NE	N/A

Catalog numbers (Cat No.) highlighted in bold blue have efficiency levels that meet EISA requirements

Blue shaded areas are Cast Iron Frames

* Requires nameplate modification

@ Requires larger fan

Continued on next page.

Blue Chip® Severe Duty / Automotive Duty NEMA Premium® XRI® IEEE-841

Totally Enclosed, Rigid Base, Three Phase

HP	RPM	VOLTS	FRAME	CAT. NO.	MODEL NO.	STOCK	CT SPEED RANGE*	LIST PRICE	MULT. SYMB.	NOM. EFF.	F.L. AMPS	WEIGHT	"C" DIM.	FOOT NOTES	C FACE KITS
200	3600	460	445TS	W616	445TSHFN9005		2:1	\$28,477	E9	95.8	223	2300	39.37	H,SL	A195
	1800	460	445T	W618	445THFN9038		20:1@	\$23,528	E9	96.2	226	2437	43.19	RB	A194
	1800	460	445T	W618-P	445THFN19070	√	20:1@	\$25,410	E9	96.2	226	2437	43.19	P,RB	A194
	1800	460	445TS	W617	445TSHFN9028		20:1@	\$23,528	E9	96.2	226	2700	39.37		A195
	1800	460	447/9T	W619	449THFS9030		20:1@	\$27,056	E9	96.5	225	2700	51.69		N/A
	1800	575	445T	W642	445THFN19034	√	20:1@	\$27,056	E9	96.2	181	2437	43.19		A194
	1200	460	447/9T	W621	449THFS19092		20:1@	\$29,886	E9	95.8	225	2927	51.84		N/A
	1200	460	447/9T	W622	449THFS9088		20:1@	\$29,886	E9	95.8	240	2927	51.69	RB	N/A
	1200	575	447/449T	W630	449THFS19079		20:1@	\$29,886	E9	95.8	192	2927	51.69	RB	N/A
250	3600	460	447/9TS	W624	449TSHFS9003		2:1	\$35,914	E9	96.5	274	2700	47.94		N/A
	1800	460	447/9T	W626	449THFS9028		20:1@	\$33,946	E9	96.5	285	2830	51.69		N/A
	1800	460	447/9T	W626-P	449THFS19342	√	20:1@	\$36,662	E9	96.5	285	2830	51.69	P	N/A
300	1800	460	447/9T	W632	449THFS9027		20:1@	\$34,625	E9	96.5	339	3211	51.84		N/A
350	3600	460	447/9TS	W634	449TSHFS9001		2:1	\$53,384	E9	96.2	382	3064	47.94	SL	N/A
	1800	460	L447/9T	W635	449THFS9036		2:1	\$44,015	E9	96.2	395	3350	51.84	RB,SL	N/A

Catalog numbers (Cat No.) highlighted in bold blue have efficiency levels that meet EISA requirements

Blue shaded areas are Cast Iron Frames

* Requires nameplate modification
@ Requires larger fan

Hazardous Duty™ Division 1 Explosion Proof Class I and II, Groups D, F & G

Blue Chip® Severe Duty, NEMA Premium Efficiency, Three Phase

Features:

- 10:1 Variable torque, see Inverter Duty column for constant torque
- CR200 Corona Resistant, 200°C rated magnet wire
- 1.15 Service Factor
- Normally closed thermostats (must be connected to control circuit)
- Meets temperature code T3B
- All cast iron construction • External surface treated with epoxy paint
- Nameplated 60/50 hertz, 190/380 Volts, at next lower horsepower as noted
- UL Listed
- CSA Certified File No. LR47504
- Three year warranty



EXPLOSION PROOF

C-Face Footed (Rigid Base)

Suitable for use on VFD per guidelines on page 17.

HP	RPM	VOLTS	FRAME	CAT. NO.	MODEL NO.	STOCK	CT SPEED RANGE	LIST PRICE	MULT. SYMB.	NOM. EFF.	F.L. AMPS	WEIGHT	"C" DIM.	FOOT NOTES
1	1800	208-230/460	143TC	C361A	143TTGN6551	√	10:1	\$886	E7	85.5	3.0-3.0/1.5	72	15.23	80
1 1/2	1800	208-230/460	145TC	C362A	145TTGN6536	√	10:1	\$938	E7	86.5	4.7-4.6/2.3	88	15.23	80
2	1800	208-230/460	145TC	C363A	145TTGN6549	√	10:1	\$986	E7	86.5	6.2-6.0/3.0	90	15.23	80
3	1800	208-230/460	182TC	C364A	182TTGN6569	√	10:1	\$1,146	E7	89.5	8.4-8.0/4.0	154	16.62	
		575	182TC	C368A	182TTGN6536	√	10:1	\$1,146	E7	89.5	3.2	158	16.62	
5	1800	208-230/460	184TC	C365A	184TTGN6575	√	10:1	\$1,249	E7	89.5	13.8-12.4/6.2	168	18.62	
		575	184TC	C369A	184TTGN6537	√	10:1	\$1,249	E7	89.5	5.0	167	18.62	
7 1/2	1800	208-230/460	213TC	C366A	213TTGN6528	√	10:1	\$1,698	E7	91.7	20.8-19.2/9.6	255	20.45	
		575	213TC	C370A	213TTGN6536	√	10:1	\$1,698	E7	91.7	7.7	275	20.45	
10	1800	208-230/460	215TC	C367A	215TTGN6528	√	2:1	\$1,953	E7	91.7	27.0-25.0/12.5	228	23.45	
		575	215TC	C371A	215TTGN16534		2:1	\$1,953	E7	91.7	10.0	201	23.45	

Catalog numbers (Cat No.) highlighted in bold blue have efficiency levels that meet EISA requirements

Blue shaded areas are Cast Iron Frames

Hazardous Duty™ Division 1 Explosion Proof Class I and II, Groups C, D, E (as noted), F & G

Steel Frame, Standard and NEMA Premium Efficiencies, Three Phase

Features:

- 1.0 Service Factor (except as noted)
- Meets temperature code T3B
- Explosion proof conduit box included, shipped loose
- UL Listed File No. E12044
- CSA Certified File No. LR47504
- K717 is rated for Class I Group D, Class II Groups F&G only
- Automatic Overload (except as noted)



EXPLOSION PROOF

Rigid Base

Suitable for use on VFD per guidelines on page 17.

HP	RPM	VOLTS	FRAME	GROUP E	CAT. NO.	MODEL NO.	STOCK	LIST PRICE	MULT. SYMB.	NOM. EFF.	F.L. AMPS	WEIGHT	"C" DIM.	FOOT NOTES	
1/4	1800	230/460	48	N	K717	5K32GNB249	✓	\$578	F1	62.5	1.2/0.6	19	9.68		
	1800	208-230/460	56	N	G646	56T17E5308	✓	\$545	F1	71.0	1.1-1.1/55	25	11.97	N	
	1800	575	56	N	G664	56T17E5314	✓	\$545	F1	71.0	0.43	25	11.97	N	
1/3	1800	208-230/460	56	N	G647	56T17E5309	✓	\$580	F1	74.0	1.3-1.2/60	25	11.97	N	
	1800	575	56	N	G665	56T17E5315		\$580	F1	74.0	0.5	25	11.97	N	
	1200	230/460	56	N	K2101	5K49FN6381	✓	\$783	F1	62.0	2.2/1.1	29	13.44		
1/2	3600	208-230/460	56	N	G648	56T34G5303		\$533	F1	66.5	2.1-2.4/1.2	30	13.44		
	1800	208-230/460	56	N	G649	56T17G5312	✓	\$613	F1	68.0	2.3-2.4/1.2	28	13.94		
	1800	200	56	N	K2102	5K49JN4582		\$701	F1	68.0	2.75	29	13.94		
	1800	575	56	N	G666	56T17G5321	✓	\$613	F1	68.0	1.0	28	13.94		
	1200	230/460	56	N	K2104	5K49HN6385	✓	\$825	F1	68.0	2.7/1.35	34	13.44		
3/4	3600	208-230/460	56	N	G660	56T34G5304		\$585	F1	74.0	3.0-3.2/1.6	30	13.44		
	1800	208-230/460	56	N	G661	56T17G5313	✓	\$647	F1	75.5	2.9-3.0/1.5	30	13.94		
	1800	200	56	N	K2105	5K49JN4574		\$747	F1	75.5	3.45	31	13.94		
	1800	575	56	N	G667	56T17G5322	✓	\$647	F1	75.5	1.2	29	13.94		
	1200	208-230/460	143T	N	K2107	5K49MN8349	✓	\$883	F1	74.0	3.2-3.2/1.6	42	14.00		
	1200	208-230/460	56	N	K2116	5K49MN6382	✓	\$878	F1	74.0	3.2-3.2/1.6	42	13.94		
1	3600	208-230/460	56	N	G662	56T34G5305	✓	\$621	F1	74.0	3.9-3.6/1.8	28	13.44		
	1800	208-230/460	56	N	G663	56T17G5314	✓	\$653	F1	77.0	3.5-3.6/1.8	31	13.94		
	1800	208-230/460	143T	Y	I502	143TTGR16026	✓	\$1,016	E7	85.5	3.3-3.3/1.65	48	16.00	TS	
	1800	575	56	N	G668	56T17G5323	✓	\$653	F1	77.0	1.45	31	13.94		
	1800	575	143T	Y	I503	143TTGR16030		\$1,016	E7	85.5	1.3	48	16.00	A,TS	
	1200	230/460	56H	N	K2110	5K49TN6383	✓	\$921	F1	77.0	3.4/1.7	47	15.50		
	1200	208-230/460	145T	Y	I504	145TTGR16076	✓	\$1,230	E7	82.5	3.8-3.8/1.9	58	16.50	TS	
	1200	575	145T	Y	I505	145TTGR16080		\$1,230	E7	82.5	1.5	58	16.50	TS	
	1 1/2	3600	208-230/460	143T	Y	I506	143TTGR16001	✓	\$941	E7	84.0	4.0/2.0	38	14.50	TS
	3600	575	143T	Y	I507	143TTGR16005	✓	\$941	E7	84.0	1.6	38	14.50	TS	
2	1800	208-230/460	56H	N	K2111	5K49NN4580	✓	\$823	F1	80.0	4.8-4.8/2.4	42	14.08		
	1800	208-230/460	145T	Y	I508	145TTGR16038	✓	\$963	E7	86.5	4.7-4.6/2.3	42	16.00	TS	
	1800	575	145T	Y	I509	145TTGR16030	✓	\$963	E7	86.5	1.85	42	16.00	A,TS	
	3600	208-230/460	145T	Y	I512	145TTGR16002	✓	\$1,411	E7	85.5	5.6-5.0/2.5	47	16.50	TS	
	3600	575	145T	Y	I513	145TTGR16004	✓	\$1,411	E7	85.5	2.0	47	16.50	TS	
2	1800	208-230/460	145T	Y	I514	145TTGR16040	✓	\$1,176	E7	86.5	6.0-5.6/2.8	55	16.50	A,TS	
	1800	575	145T	Y	I515	145TTGR16039	✓	\$1,176	E7	86.5	2.4	55	16.50	A,TS	

Catalog numbers (Cat No.) highlighted in bold blue have efficiency levels that meet EISA requirements

Hazardous Duty™ Division 1 Explosion Proof Class I and II, Groups C, D, F & G

Severe Duty, Standard and EPart Efficiencies, Three Phase

Features:

- Frame Construction
- Thermal Protection
- Class/Group
- Temperature Code
- Conduit Box
- Service Factor
- UL File
- CSA File

56 Frame

- Rolled Steel
- Auto Overload
- Class I, Groups C & D,
- Class II, Groups F & G
- T3B
- Shipped Loose
- 1.0 (unless otherwise noted)
- E12044
- LR47504

143-256TC

- Cast Iron "Blue Chip"
- T-Stats
- Class I, Group D
- Class II, Groups F & G
- T3B
- Installed
- 1.0 (unless otherwise noted)
- E12044
- LR47504



EXPLOSION PROOF

C-Face Footless

Suitable for use on VFD per guidelines on page 17.

HP	RPM	VOLTS	FRAME	CAT. NO.	MODEL NO.	STOCK	CT SPEED RANGE*	LIST PRICE	MULT. SYMB.	NOM. EFF.	F.L. AMPS	WEIGHT	"C" DIM.	FOOT NOTES
1/4	1800	208-230/460	56C	G827	56T17E5310	✓	-----	\$512	F1	71.0	1.1-1.1/0.55	25	11.97	CD,N
	1800	575	56C	G842	56T17E5312		-----	\$512	F1	71.0	0.43	25	11.97	CD,N
1/3	1800	208-230/460	56C	G828	56T17E5311	✓	-----	\$541	F1	74.5	1.3-1.2/0.6	25	11.97	CD,N
	1800	575	56C	G843	56T17E5313	✓	-----	\$541	F1	74.5	0.50	25	11.97	CD,N
1/2	1800	208-230/460	56C	G829	56T17G5315	✓	-----	\$570	F1	68.0	2.3-2.4/1.2	28	13.94	CD
	1800	575	56C	G844	56T17G5318		-----	\$570	F1	68.0	1.0	32	13.94	CD
3/4	1800	208-230/460	56C	G840	56T17G5316	✓	-----	\$601	F1	75.5	2.9-3.0/1.5	29	13.94	CD
	1800	575	56C	G845	56T17G5319	✓	-----	\$601	F1	75.5	1.2	29	13.94	CD
1	1800	208-230/460	56C	G841	56T17G5317	✓	-----	\$608	F1	77.0	3.5-3.6/1.8	30	13.94	CD
	1800	575	56C	G846	56T17G5320	✓	-----	\$608	F1	77.0	1.45	32	13.94	CD
1 1/2	1800	208-230/460	143TC	C320A	143TTGN4062	✓	10:1	\$748	E7	82.5	3.4-3.6/1.8	55	15.18	18,68
	3600	208-230/460	143TC	C301A	143TTGN4020		10:1	\$777	E7	82.5	4.6-4.4/2.2	54	15.18	18,68
2	1800	208-230/460	56C	K2115	5K49NN4581		-----	\$868	F1	80.0	4.8-4.8/2.4	38	14.44	18,CD
	1800	208-230/460	145TC	C321A	145TTGN4337	✓	10:1	\$791	E7	84.0	4.6-4.4/2.2	60	15.18	18,68
3	3600	208-230/460	145TC	C302A	145TTGN4022		2:1	\$844	E7	84.0	5.6-5.4/2.7	59	13.98	18,68
	1800	208-230/460	145TC	C322A	145TTGN4338	✓	10:1	\$834	E7	84.0	6.0-5.6/2.8	69	15.18	18,68
5	3600	208-230/460	182TC	C303A	182TTGN4315	✓	10:1	\$928	E7	85.5	8.4-7.4/3.7	119	18.62	68
	1800	230/460	182TC	C323A	182TTGN4068	✓	2:1	\$992	E7	87.5	8.8-8.0/4.0	112	18.62	68
7 1/2	3600	208-230/460	184TC	C304A	184TTGN4313	✓	2:1	\$1,165	E7	87.5	12.4-11.8/5.9	133	18.62	68
	1800	230/460	184TC	C324A	184TTGN4072	✓	2:1	\$1,078	E7	87.5	14.7-13/6.5	132	18.62	68
10	3600	230/460	213TC	C305	213TTGS14015	✓	2:1	\$1,543	E7	88.5	19.0/9.5	241	22.25	68
	1800	208-230/460	213TC	C325A	213TTGN4067	✓	2:1	\$1,474	E7	89.5	22.0-20.0/10.0	194	23.45	68
15	3600	230/460	215TC	C306	215TTGS14020	✓	2:1	\$1,703	E7	90.2	24.0/12.0	271	22.25	68
	1800	208-230/460	215TC	C326A	215TTGN4065	✓	2:1	\$1,688	E7	89.5	27.2-25.0/12.5	216	23.45	68
20	3600	230/460	254TC	C307A	254TTGP14013	✓	2:1	\$2,210	E7	90.2	35/17.5	331	24.19	68
	1800	230/460	254TC	C327A	254TTGN14042	✓	2:1	\$2,176	E7	91.0	39/19.5	370	25.77	68
25	3600	230/460	256TC	C308A	256TTGN14011		2:1	\$2,654	E7	90.2	47.0/23.5	340	25.77	68
	1800	208-230/460	256TC	C328A	256TTGN14044	✓	2:1	\$2,721	E7	91.0	50.0/25.0	315	25.94	68

Catalog numbers (Cat No.) highlighted in bold blue have efficiency levels that meet EISA requirements

Blue shaded areas are Cast Iron Frames

* Requires nameplate modification

Hazardous Duty™ Division 1 Explosion Proof Class I and II, Groups C (as noted), D, F & G Blue Chip® Severe Duty, EAct Efficiency, Three Phase



Features:

- 1.15 Service Factor on sinewave
- 10:1 Variable torque, constant torque speed range as indicated @1.0 SF
- Class F insulation
- CR200 Corona Resistant, 200°C rated magnet wire
- Ball Bearings (except as noted)
- All cast iron construction
- Normally closed thermostats (must be connected to control circuit)
- Meets temperature code T3B
- Shaft slinger
- External surface treated with epoxy
- See Modification section for addition of C-Face Kits (254T-445T)
- Meets IEEE45 USCG Marine Duty, IP 54 construction
- Contact Marathon Motors for F2 mounting
- UL Listed File No. E12044
- CSA Certified File No. LR47504,
- Two year warranty

EXPLOSION PROOF

Rigid Base

Suitable for use on VFD per guidelines on page 17.

HP	RPM	VOLTS	FRAME	GROUP C	CAT. NO.	MODEL NO.	STOCK	CT SPEED RANGE	LIST PRICE	MULT. SYMB.	NOM. EFF.	F.L. AMPS	WEIGHT	"C" DIM.	FOOT NOTES
1	1800	575	143T	N	U020	143TTGN4030		10:1	\$691	E7	82.5	1.2	62	13.48	25,80
1 1/2	1800	575	145T	N	U021	145TTGN4035		10:1	\$737	E7	84.0	1.8	74	14.73	25,80
2	1800	575	145T	N	U022	145TTGN4040		10:1	\$780	E7	85.5	2.4	78	14.73	25,80
3	1800	575	182T	N	U023	182TTGS4030		10:1	\$890	E7	87.5	3.4	128	16.19	25
5	1800	575	184T	N	U024	184TTGS4030		10:1	\$976	E7	86.5	5.2	142	17.44	25
7 1/2	1800	575	213T	N	U025	213TTGS4030		10:1	\$1,321	E7	89.5	8.0	221	19.66	25
10	1800	575	215T	N	U026	215TTGS4030		2:1	\$1,540	E7	89.5	10.0	225	20.91	25
15	1800	575	254T	Y	U027	254TTGN4030		10:1	\$1,974	E7	91.0	15.6	365	23.52	
20	1800	575	256T	Y	U028	256TTGN4030		2:1	\$2,362	E7	91.0	20.0	379	25.27	
25	1800	575	284T	Y	U029	284TTGP4030		2:1	\$3,005	E7	92.4	24.8	325	26.26	
30	1800	575	286T	Y	U030	286TTGP4030		2:1	\$3,484	E7	92.4	29.6	496	27.76	87
40	1800	575	324T	Y	U031	324TTGP4030		2:1	\$4,639	E7	93.0	40.0	520	28.97	17,87
50	1800	575	326T	Y	U032	326TTGP4030		2:1	\$5,647	E7	93.0	49.0	520	30.47	17,87
60	1800	575	364T	Y	U033	364TTGS4040		2:1	\$8,204	E7	93.6	57.5	1055	31.5	87
75	1800	575	365T	Y	U034	365TTGS4040		2:1	\$10,094	E7	94.1	71.0	1094	32.5	87
100	1800	575	405T	Y	U035	405TTGS4040		2:1	\$12,412	E7	94.5	91.0	1365	37.12	87
125	1800	575	444T	Y	U036	444TTGS4042		2:1	\$16,030	E7	94.5	113.0	1808	41.25	87
150	1800	575	445T	Y	U037	445TTGN4030		10:1	\$19,798	E7	95.0	138.0	2236	43.19	
200	1800	575	445T	Y	U038	445TTGN4045		2:1	\$22,400	E7	95.0	180.0	2384	43.19	RB,87

Catalog numbers (Cat No.) highlighted in bold blue have efficiency levels that meet EISA requirements

Blue shaded areas are Cast Iron Frames

Hazardous Duty™ Division 1 Explosion Proof, NEMA Premium® XRI®, Class I and II, Groups C, D, F & G Blue Chip® Severe Duty, Three Phase

Features:

- ⚙️ Meets NEMA Premium® efficiencies
- Bearing Current Protection (BCP), as noted
- 10:1 Variable torque, see Inverter Duty column for constant torque
- MAX GUARD® Class F insulation
- Blue Chip® quality, 100% cast iron construction for rigidity and reduced vibration
- Internal and external surfaces treated with epoxy paint
- 1.15 Service Factor on sinewave or 1.0 Service Factor on IGBT power
- Precision balanced to .08"/sec.
- Extended grease tubes
- Normally closed thermostats (must be connected to control circuit)
- Meets temperature code T3B
- Shaft slinger
- Nameplated 60/50 Hz, 190/380 Volts, at next lower HP, as noted
- See MOD CENTRAL for:
 - C-Face Kit Modifications
 - F2 mounting
- Ball Bearings (except as noted)
- UL Listed File No. E12044
- CSA Certified File No. LR47504
- Three year warranty



EXPLOSION PROOF

Rigid Base

Suitable for use on VFD per guidelines on page 17.

HP	RPM	VOLTS	FRAME	GROUP C	CAT. NO.	MODEL NO.	STOCK	CT SPEED RANGE	LIST PRICE	MULT. SYMB.	NOM. EFF.	F.L. AMPS	WEIGHT	"C" DIM.	FOOT NOTES	
3/4	1200	208-230/460	143T	N	H350	143TTGN7076	✓	10:1	\$721	E7	74.0	3.1-3.2/1.6	55	12.48	25,68,80,91	
	1	1800	208-230/460	143T	N	U001A	143TTGN6526	✓	10:1	\$804	E7	85.5	3.0-3.0/1.5	68	13.48	25,68,80,91
		1800	575	143T	N	U020A	143TTGN6530	✓	10:1	\$804	E7	85.5	1.3	68	14.73	25,80
	1800	208-230/460	143T	Y	U986A	143TTGN6532	✓	10:1	\$969	E7	85.5	3.0-3.0/1.5	68	13.48	25,68,80,91	
1 1/2	1200	208-230/460	145T	N	U039A	145TTGN6576	✓	10:1	\$969	E7	82.5	4.0-3.6/1.8	76	14.73	25,68,80,91	
	3600	208-230/460	143T	N	U058A	143TTGN6501	✓	10:1	\$861	E7	84.0	4.4-4.0/2.0	70	13.48	25,68,80,91	
		1800	208-230/460	143T	N	U002A	145TTGN6526	✓	10:1	\$858	E7	86.5	4.7-4.6/2.3	83	14.73	25,68,80,91
	1800	575	145T	N	U021A	145TTGN6537	✓	10:1	\$858	E7	86.5	1.8	85	14.73	25,80	
	1800	208-230/460	145T	Y	U987A	145TTGN16532	✓	10:1	\$1,031	E7	86.5	4.7-4.6/2.3	81	14.73	25,80,91	
	1200	208-230/460	182T	N	U040A	182TTGN6576	✓	10:1	\$1,010	E7	87.5	4.8-4.4/2.2	147	15.87	25,68,91	
	2	3600	208-230/460	145T	N	U059A	145TTGN6501	✓	10:1	\$1,010	E7	85.5	5.6-5.2/2.6	70	13.48	25,68,80,91
		1800	208-230/460	145T	N	U003A	145TTGN6527	✓	10:1	\$908	E7	86.5	6.2-6.0/3.0	86	14.73	25,68,80,91
3	1800	575	145T	N	U022A	145TTGN6540	✓	10:1	\$908	E7	86.5	2.4	86	14.73	25,80	
	1800	208-230/460	145T	Y	U988A	145TTGN6550	✓	10:1	\$1,093	E7	86.5	6.2-6.0/3.0	83	14.73	25,80,91	
	1200	208-230/460	184T	Y	U041A	184TTGN6576	✓	10:1	\$1,143	E7	88.5	6.4-6.0/3.0	154	17.87	25,68,91	
	3600	208-230/460	182T	N	U060A	182TTGN6501	✓	10:1	\$1,045	E7	87.5	8.4-7.6/3.8	141	15.87	25,68,91	
		1800	208-230/460	182T	N	U004A	182TTGN6526	✓	10:1	\$1,035	E7	89.5	8.4-8.0/4.0	143	15.87	25,68,91
	1800	575	182T	N	U023A	182TTGN6530	✓	10:1	\$1,035	E7	89.5	3.2	141	15.87	25	
5	1800	208-230/460	182T	Y	U989-P	182TTGN6541	✓	10:1	\$1,394	E7	89.5	8.4-8.0/4.0	161	15.87	25,68,91,P	
	1200	208-230/460	213T	N	U042A	213TTGN6576	✓	10:1	\$1,464	E7	89.5	8.8/4.4	244	19.63	25,68	
	3600	208-230/460	184T	N	U061A	184TTGN6501	✓	10:1	\$1,270	E7	88.5	13.0-12.0/6.0	161	17.87	25,68,91	
		1800	208-230/460	184T	Y	U005A	184TTGN6526	✓	10:1	\$1,135	E7	89.5	13.8-12.4/6.2	155	17.87	25,68,91
1800	575	184T	N	U024A	184TTGN6530	✓	10:1	\$1,135	E7	89.5	5.0	156	17.87	25		
	1800	208-230/460	184T	Y	U990-P	184TTGN6544	✓	10:1	\$1,530	E7	89.5	13.8-12.4/6.2	150	17.87	25,68,91,P	
1200	230/460	215T	N	U043A	215TTGN6576	✓	10:1	\$1,876	E7	89.5	13.8/6.9	206	22.63	25,68		

Catalog numbers (Cat No.) highlighted in bold blue have efficiency levels that meet EISA requirements

Blue shaded areas are Cast Iron Frames

Continued on next page.

Hazardous Duty™ Division 1 Explosion Proof, NEMA Premium® XRI®, Class I and II, Groups C, D, F & G Blue Chip® Severe Duty, Three Phase

Rigid Base

HP	RPM	VOLTS	FRAME	GROUP C	CAT. NO.	MODEL NO.	STOCK	CT SPEED RANGE	LIST PRICE	MULT. SYMB.	NOM. EFF.	F.L. AMPS	WEIGHT	"C" DIM.	FOOT NOTES
75	3600	230/460	365TS	Y	E575	365TSTGS16503	✓	10:1@	\$11,060	E7	94.1	169/84.5	1097	30.38	87
	1800	230/460	365T	Y	E576A	365TTGS16540	✓	2:1	\$11,007	E7	95.4	174/87.0	1124	32.50	A,68
	1800	575	365T	Y	U034A	365TTGS16542	✓	2:1	\$11,007	E7	95.4	69.0	1094	32.50	A
	1800	208-230/460	365TS	Y	U081A	365TSTGS16532		2:1	\$11,007	E7	95.4	174/87	1087	30.38	A,68
	1200	230/460	405T	Y	E577	405TTGS6589	✓	10:1@	\$13,283	E7	94.5	180/90.0	1388	37.12	87
100	3600	230/460	405TS	Y	E578	405TSTGS6503		10:1	\$14,962	E7	94.5	216/108	1349	34.12	87
	1800	230/460	405T	Y	E594	405TTGS6548	✓	2:1	\$13,577	E7	95.4	226/113	1479	37.12	68
	1800	575	405T	Y	U035A	405TTGS16539	✓	2:1	\$13,577	E7	95.4	90.5	1365	37.12	87
	1800	208-230/460	405TS	Y	U082A	405TSTGS16531		2:1	\$13,577	E7	95.4	226/113	1333	34.12	87
	1200	230/460	444T	Y	E580A	444TTGN16580	✓	10:1@	\$18,980	E7	95.0	248/124	1813	41.35	68,87
125	3600	460	444TS	Y	U073A	444TSTGN16502		2:1	\$24,057	E7	94.5	139	1824	36.70	68
	1800	460	444T	Y	E582A	444TTGN16532	✓	10:1@	\$19,926	E7	95.4	143	1845	41.35	68
	1800	575	444T	Y	U036A	444TTGN16533	✓	10:1@	\$19,926	E7	95.4	114	1808	41.35	
	1800	460	444TS	Y	U083A	444TSTGN16531		10:1@	\$19,926	E7	95.4	143	1835	37.60	
	1200	460	445T	Y	E583	445TTGN6597		---	\$21,820	E7	95.0	155	2200	43.25	
150	3600	460	445TS	Y	E584	445TSTGN16505		---	\$28,159	E7	95.0	168	1941	39.60	
	1800	460	445T	Y	E585	445TTGN6542	✓	2:1	\$20,729	E7	95.4	172	2173	43.35	68
	1800	575	445T	Y	U037A	445TTGN16544	✓	2:1	\$20,729	E7	95.4	138	2236	43.35	
	1800	460	445TS	Y	U084A	445TSTGN16531		2:1	\$20,729	E7	95.4	172	2163	39.60	68
	1200	460	445T	Y	U090A	445TTGN16588	✓	---	\$23,454	E7	95.8	181	2384	43.35	RB,68
200	3600	460	445TS	Y	U075A	445TSTGN16506		---	\$34,359	E7	95.4	226	2395	39.6	
	1800	460	445T	Y	E588	445TTGN6538	✓	10:1@	\$23,500	E7	96.2	224	2500	43.19	68
	1800	575	445T	Y	U038A	445TTGN16543	✓	10:1@	\$23,500	E7	96.2	179	2384	43.35	RB
	1200	460	449T	Y	U091A	449TTGS16585		10:1	\$33,349	E7	95.8	240	2878	51.85	RB,68
250	3600	460	449TS	Y	E595	449TSTGS14003		---	\$34,888	E7	96.5	275	2867	47.94	NE,17,68,87
	1800	460	449T	Y	E591	449TTGS16537	✓	10:1	\$28,830	E7	96.5	285	3012	51.85	RB
	1800	460	449T	Y	H502	449TTGS7068		2:1	\$26,974	E7	95.0	290	2779	51.85	RB,17,68,87
300	1800	460	449T	Y	H503	449TTGS7037		2:1	\$30,039	E7	96.5	338	3032	51.85	RB,17,68,87
350	1800	460	449T	Y	H504	449TTGS7036	✓	---	\$33,688	E7	96.2	400	3280	51.85	RB,17

EXPLOSION PROOF

Catalog numbers (Cat No.) highlighted in bold blue have efficiency levels that meet EISA requirements

Blue shaded areas are Cast Iron Frames

@ Requires larger fan

"R164 Rework" Table:

R-164 Rework for 10:1 Constant Torque: Fan Change* & Re-Nameplate

FRAME	LIST PRICE
143-215	\$230
254-286	\$263
324-326	\$296
364-365	\$296
404-449	\$329

Multiplier Symbol S4

* Fan change to allow 10:1 constant torque may reduce motor full load efficiency below EPAAct levels.

Operation of motor on non-sinusoidal wave form (VFD) exempts motor from EPAAct mandated efficiency levels.

Medium Voltage Motors

Marathon Motors's Medium Voltage motors are available through 6000 horsepower, and through 13.2 kV (13,200 volts). Enclosures include Dripproof (ODP), WP1, WPII, Totally Enclosed Fan Cooled (TEFC), Totally Enclosed Air-to-Air Cooled (TEAAC) and Totally Enclosed Water-to-Air Cooled (TEWAC). Contact Marathon Motors for a quotation on any ratings or configurations not listed below.



Medium Voltage ODP/TEFC

Range:
TEFC: 125-2500HP, 90-1850kW
ODP: 125-5000HP, 90-3700kW
Voltage: 2,300-13,800V
Pole: 2-, 4-, 6-, pole
Hertz: 50 or 60 Hertz
Frame: 449-5013 NEMA, 355-560 IEC
Protection: IP22 through IP56
Insulation: Class H&F VPI
Fabricated Steel or Cast Iron Construction
Performance: NEMA / IEC
Bearings: Anti-Friction
Service Factor: 1.15
Inverter: Yes
Warranty: 12/18 mo. & 12/24 mo. UL / CSA

ANEMA ODP/WP1

Range: 250-6000HP, 185-4600kW
Voltage: 2300-13800V
Pole: 2-, 4-, 6-, pole
Hertz: 50 or 60 Hertz
Frame: 5000-5800 NEMA, 355-900 IEC
Protection: IP23
Insulation: Class F VPI
Construction: Fabricated
Performance: NEMA / IEC
Bearings: Anti-Friction, sleeve available
Service Factor: 1.15
Inverter: Yes
Warranty: 12/24 mo. UL / CSA

ANEMA WPII

Range: 250-6000HP, 185-4600kW
Voltage: 2300-13800V
Pole: 2-, 4-, 6- pole
Hertz: 50 or 60 Hertz
Frame: 5000-5800 NEMA, 355-900 IEC
Protection: IPW23
Insulation: Class F VPI
Construction: Fabricated
Performance: NEMA / IEC
Bearings: Anti-Friction, sleeve available
Service Factor: 1.15
Inverter: Yes
Warranty: 12/24 mo. UL / CSA

ANEMA TEAAC/TEWAC

Range: 300-6000HP, 225-4600kW
Voltage: 2300-13800V
Pole: 2-, 4-, 6- pole
Hertz: 50 or 60 Hertz
Frame: 355-900 IEC
Protection: IP44
Insulation: Class F VPI
Construction: Fabricated
Performance: IEC
Bearings: Anti-Friction, sleeve available
Service Factor: 1.15
Inverter: Yes
Warranty: 12/24 mo. UL / CSA

MEDIUM VOLTAGE

Features:

	Dripproof, 449-510 frame	Totally Enclosed, 449 frame	Totally Enclosed, 5000 frame
NEMA Premium efficiencies as noted (Table 12-13)	X	X	X
Cast iron construction B-10 life on direct-coupled loads	X	X	X
Open Conrad radial ball bearings rated for 100,000 hour B-10 life on direct-coupled loads	X	X	X
Roller bearing for belted loads	OPT	OPT	OPT
Oversized, fabricated steel conduit box	X		
Oversized, cast iron conduit box		X	X
1.15 Service Factor as available (consult factory)	OPT	OPT	OPT
Class H insulation and form wound coils	X	X	X
Epoxy, 100% solids, Vacuum Pressure Impregnation (VPI) resin	X	X	X
Grease fittings with extended grease tubes		X	X
Internal and external epoxy finish		X	X
Front and rear cast iron bearing caps		X	X
Actual test and vibration data included with each order		X	X
CSA Certified for Div. 2/Zone 2, Group A, B, C, D and Group IIA, IIB, IIC		X	X
Temp Code T3 @ 1.0 Service Factor		X	
Temp Code T2C @ 1.0 Service Factor			X
Temp Code T2B @ 1.15 Service Factor		X	X
IEEE-841 features		OPT	OPT
Provisions for jacking bolts in all four feet			X
Rotating shaft seals, Inpro® Smart Rings on each end			X
Provisions for dowel pins in drive end feet			X
Ground provisions on foot and in the conduit box			X
Dedicated 5009 frame for vertical applications			X
Frames drilled with four sets of footholes, 5009, 5010, 5011, 5012			X

Medium Voltage Motors

Multiplier Symbol S4

HP	RPM	DRIPPROOF				TOTALLY ENCLOSED			
		NEMA PREMIUM	FRAME	CAT. NO.	LIST PRICE	NEMA PREMIUM	FRAME	CAT. NO.	LIST PRICE
100	900	---	---	---	---	N/A	447/9T	Y255	\$44,021
125	1800	---	---	---	---	N/A	L447/9T	Y256	\$36,841
	1200	---	---	---	---	N/A	447/9T	Y257	\$46,638
	900	N/A	449T	Y948	\$31,755	N/A	5011LS	Y913	\$50,854
150	3600	---	---	---	---	N/A	447/9TS	Y903	\$40,169
	1800	---	---	---	---	N/A	L447/9T	Y900	\$38,365
	1200	---	---	---	---	N/A	447/9T	Y904	\$48,291
	900	N/A	508U	Y949	\$36,639	N/A	5011LS	Y914	\$55,271
200	3600	---	---	---	---	N/A	L447/9TS	Y905	\$42,734
	1800	N/A	449T	Y950	\$30,612	N/A	L447/9T	Y901	\$40,799
	1200	N/A	449T	Y958	\$33,408	N/A	L447/9T	Y906	\$48,853
	1200	---	---	---	---	N/A	5011LS	Y920	\$49,763
	900	N/A	508U	Y250	\$42,366	N/A	5011LS	Y915	\$58,343
250	3600	N/A	449TS	Y954	\$36,953	N/A	5011S	Y258	\$53,013
	1800	N/A	449T	Y951	\$32,220	Y	L447/9T	Y902	\$44,352
	1200	N/A	508U	Y955	\$35,172	Y	L447/9T	Y907	\$54,020
	1200	---	---	---	---	Y	5011LX	Y921	\$55,424
	900	N/A	510U	Y251	\$46,048	N/A	5011LS	Y916	\$60,035
300	3600	N/A	449TS	Y956	\$38,415	N/A	5011S	Y259	\$54,624
	1800	---	---	---	---	Y	L447/9T	Y908	\$49,927
	1800	N/A	508U	Y952	\$35,163	Y	5011LS	Y922	\$52,040
	1200	N/A	508U	Y942	\$38,140	Y	5011LS	Y923	\$58,781
	900	N/A	510U	Y252	\$59,657	N/A	5013LS	Y917	\$69,192
350	3600	N/A	449TS	Y957	\$39,892	N/A	5011S	Y260	\$55,430
	1800	N/A	508U	Y953	\$36,435	Y	5011LS	Y924	\$52,770
	1200	N/A	508U	Y943	\$41,168	Y	5011LS	Y925	\$61,156
	1200	---	---	---	---	Y	5011LX	Y935	\$64,542
	900	---	---	---	---	N/A	5013LS	Y918	\$77,531
400	3600	N/A	508U	Y910	\$43,857	N/A	5011S	Y261	\$61,100
	1800	Y	508U	Y940	\$37,684	Y	5011LS	Y926	\$56,443
	1800	---	---	---	---	Y	5011LX	Y936	\$59,800
	1200	Y	510U	Y944	\$51,191	Y	5011LS	Y927	\$67,101
	900	---	---	---	---	N/A	5013LS	Y912	\$93,376
450	3600	---	---	---	---	N/A	5011S	Y263	\$63,146
	1800	Y	508US	Y911	\$44,726	Y	5011LS	Y928	\$60,119
	1800	Y	510U	Y941	\$40,660	Y	5011LX	Y937	\$63,474
	1200	Y	510U	Y945	\$60,053	Y	5013LS	Y929	\$72,852
	900	---	---	---	---	N/A	5013LS	Y262	\$96,676
500	1800	Y	510U	Y946	\$49,470	Y	5011LS	Y930	\$66,129
	1800	---	---	---	---	Y	5011LX	Y938	\$69,486
	1200	Y	510U	Y947	\$73,192	Y	5013LS	Y931	\$77,748
600	1800	N/A	510U	Y253	\$60,366	N/A	5011LS	Y932	\$86,835
	1800	---	---	---	---	N/A	5011LX	Y939	\$90,191
700	1800	N/A	510U	Y254	\$63,514	N/A	5013LS	Y933	\$92,869
800	1800	---	---	---	---	N/A	5013LS	Y934	\$99,622

MEDIUM VOLTAGE

Inverter (Vector) Duty: microMAX™

1000:1 Constant Torque (TENV), 20:1 Constant Torque (TEFC)

Totally Enclosed, Three Phase

Applications:

Designed for direct replacement of PMDC or any other variable speed application where up to a 1000:1 constant torque speed range is required. Typical uses include: machine tools, conveyors, packaging machines, batching machines, and printing equipment.



Features:

- Designed to replace PMDC motors (when used with a VFD)
- Constant horsepower to twice base speed (RPM)
- Class H insulation with CR200 magnet wire
- Removable base for C-Face footless mounting, as noted
- Continuous duty at 40°C ambient
- "Quick Connect" terminal board, as noted
- Top mounted conduit box as found on PMDC motors
- Eliminates brush and commutator maintenance
- UL Recognized, CSA Certified, and CE Mark
- Three year warranty

C-Face Footless

Suitable for use on VFD per guidelines on page 17.

HP	RPM	VOLTS	FRAME	CAT. NO.	MODEL NO.	STOCK	LIST PRICE	MULT. SYMB.	F.L. AMPS	WEIGHT	"C" DIM.	FOOT NOTES
1/8	1800	230	56C	Y606	056H17T2022	✓	\$235	E3	0.7	15	9.16	N,Q
1/4	1800	230	56C	Y501	056H17T2012	✓	\$254	E3	1.0	16	9.91	N,Q
1/3	1800	230	56C	Y503	056H17T2014	✓	\$274	E3	1.2	17	9.91	N,Q
1/2	1800	230	56C	Y505	056H17T2016		\$322	E3	1.8	24	9.91	N,Q
	1800	230/460	56C	Y374	056H17T2018	✓	\$322	E3	1.8/0.9	24	9.91	N
	1800	575	56C	Y375	056H17T2020		\$322	E3	0.7	24	9.91	N,Q
3/4	1800	230	56C	Y507	056H17F2012		\$398	E3	2.8	21	11.19	
	1800	230/460	56C	Y376	056H17F2018	✓	\$398	E3	2.8/1.4	21	11.19	
	1800	575	56C	Y377	056H17F2016		\$398	E3	1.1	21	11.19	
1	1800	230	56C	Y521	056H17F2014		\$448	E3	3.2	27	12.44	
	1800	230/460	56C	Y378	056H17F2022	✓	\$448	E3	3.2/1.6	27	12.44	
	1800	575	56C	Y379	056H17F2020		\$448	E3	1.3	27	12.44	

C-Face Footed (Rigid Base)

HP	RPM	VOLTS	FRAME	CAT. NO.	MODEL NO.	STOCK	LIST PRICE	MULT. SYMB.	F.L. AMPS	WEIGHT	"C" DIM.	FOOT NOTES
1/8	1800	230	56C	Y605	056H17T2021	✓	\$235	E3	0.7	18	9.16	N,Q
1/4	1800	230	56C	Y500	056H17T2011	✓	\$254	E3	1.0	17	9.91	N,Q
1/3	1800	230	56C	Y502	056H17T2013	✓	\$274	E3	1.2	17	9.91	N,Q
1/2	1800	230	56C	Y504	056H17T2015	✓	\$322	E3	1.8	22	9.91	N,Q
	1800	230/460	56C	Y360	056H17T2017	✓	\$322	E3	1.8/0.9	22	9.91	N
	1800	575	56C	Y361	056H17T2019		\$322	E3	0.7	29	9.91	N,Q
3/4	1800	230	56C	Y506	056H17F2011	✓	\$398	E3	2.8	24	11.19	
	1800	230/460	56C	Y362	056H17F2017	✓	\$398	E3	2.8/1.4	24	11.19	
	1800	575	56C	Y363	056H17F2015		\$398	E3	1.1	24	11.19	
1	1800	230	56C	Y508	056H17F2013		\$448	E3	3.2	28	12.44	
	1800	230/460	56C	Y364	056H17F2021	✓	\$448	E3	3.2/1.6	28	12.44	
	1800	575	56C	Y365	056H17F2019	✓	\$448	E3	1.3	28	12.44	
1 1/2	1800	230	145TC	Y522	145THFR5328	✓	\$557	E3	4.8	48	13.48	N,6
	1800	230/460	145TC	Y366	145THFR5329	✓	\$557	E3	4.8/2.4	48	13.48	N,6
	1800	575	145TC	Y367	145THFR5330		\$557	E3	1.9	48	13.48	N,6
2	1800	230	145TC	Y523	145THFR5326		\$739	E3	5.8	53	14.87	6
	1800	230/460	145TC	Y368	145THFR5329	✓	\$739	E3	5.8/2.9	53	14.87	6
	1800	575	145TC	Y369	145THFR5330	✓	\$739	E3	2.3	53	14.87	6

Continued on next page.

Inverter (Vector) Duty: microMAX™

1000:1 Constant Torque (TENV), 20:1 Constant Torque (TEFC)

Totally Enclosed, Three Phase

C-Face Footed (Rigid Base)

HP	RPM	VOLTS	FRAME	CAT. NO.	MODEL NO.	STOCK	LIST PRICE	MULT. SYMB.	F.L. AMPS	WEIGHT	"C" DIM.	FOOT NOTES
3	1800	230/460	182/145TC	Y370	182THFR5329	✓	\$871	E3	8.4/4.2	52	14.87	86,88
	1800	230/460	182TC	Y1999	182THFW7729	✓	\$909	E3	8.4/4.2	76	13.97	6,13
	1800	575	182/145TC	Y371	182THFR5330		\$871	E3	3.4	52	14.87	86,88
5	1800	575	182TC	Y270A	182THFW7730		\$909	E3	2.9	86	14.97	6,13
	1800	230/460	184TC	Y1372	184THFW7726	✓	\$1,034	E3	13.0/6.5	92	13.97	6,13
	1800	575	184TC	Y373A	184THFW7736	✓	\$1,034	E3	5.2	95	13.97	6,13
7 1/2	1800	230/460	213TC	Y994	213THFW7726	✓	\$1,322	E3	21.4/10.7	98	20.97	6
	1800	575	213TC	Y995	213THFW7736		\$1,322	E3	8.5	98	20.97	6
10	1800	230/460	215TC	Y996	215THFW7726	✓	\$1,691	E3	27.6/13.8	125	22.22	6
	1800	575	215TC	Y997	215THFW7736		\$1,691	E3	11.1	125	22.22	

Inverter (Vector) Duty: Max + (with Encoder)

1000:1 Constant Torque, Totally Enclosed, Three Phase

Applications:

The **MAX+** incorporates low rotor inertia for fast starts, stops, and reversals. Coupled with an encoder make this useful in applications traditionally served only by servo systems. The **MAX+** is also suitable for all applications where up to a 1000:1 Constant Torque speed range or positioning is required.

Features:

- Integrated Dynapar HS20 1024 ppr encoder
- Class F insulation with CR200 corona resistant magnet wire
- Constant Torque operation from 0 to base speed on Vector Drive
- Constant Horsepower operation up to twice base RPM
- Continuous duty at 40°C ambient
- Optimized for operation with IGBT inverter
- Removable base for C-Face footless mounting, as noted
- Ball bearings
- Field reversible to F2 (except as noted)
- UL Recognized, CSA Certified, and CE Mark
- Three year warranty



Opposite drive end shown

C-Face Footed (Rigid Base)

Suitable for use on VFD per guidelines on page 17.

HP	RPM	VOLTS	FRAME	ENCODER PPR	CAT. NO.	MODEL NO.	STOCK	LIST PRICE	MULT. SYMB.	F.L. AMPS	WEIGHT	"C" DIM.	FOOT NOTES
1/2	1800	230/460	56C	1024	Y280	056H17T15526	✓	\$992	E3	1.6/8	29	13.48	S,6,13
3/4	1800	230/460	56C	1024	Y281	056H17T15528	✓	\$1,038	E3	2.4/1.2	35	13.48	S,6,13
1	1800	230/460	56C	1024	Y282	056H17T15527	✓	\$1,099	E3	3/1.5	41	14.98	S,6,13
	1800	230/460	143TC	1024	Y283	143THTR15535	✓	\$1,183	E3	3/1.5	42	15.04	
1 1/2	1800	230/460	145TC	1024	Y284	145THTR15540	✓	\$1,308	E3	4/2	50	16.04	S,6,13
2	1800	230/460	145TC	1024	Y285	145THTN17034	✓	\$1,755	E3	6/3	75	14.68	
3	1800	230/460	182TC	1024	Y286	182HTL17041	✓	\$1,972	E3	8.4/4.2	95	17.39	d,AL
	1800	230/460	182TC	1024	Y286A	182HTY17041	✓	\$1,972	E3	8.2/4.1	95	16.19	AL
5	1800	230/460	184TC	1024	Y287	184HTL17038	✓	\$2,147	E3	14.0/7.0	112	18.94	d,AL
	1800	230/460	184TC	1024	Y287A	1184HTY17038	✓	\$2,147	E3	12.8/6.4	112	17.69	AL

Blue shaded areas are Cast Iron Frames

Inverter (Vector) Duty: Black Max® 1000:1 Constant Torque, TENV, Three Phase

Applications:

Designed for inverter or vector applications where up to a 1000:1 Constant Torque speed range is required. Typical uses include: material handling, machine tools, conveyors, crane and hoist, metal processing, test stands, pumps compressors, textile processing, and other industrial machinery installed in dusty or dirty environments.

Features:

- MAX GUARD® Class F insulation system
- Constant Torque operation from 0 to base speed on Vector Drive
- Constant Horsepower operation up to twice base RPM
- Continuous duty at 40°C ambient
- Optimized for operation with IGBT inverter (NEMA Design A)
- Normally closed thermostats (one per phase, Class F)
- Removable rigid base, as noted
- Ball Bearings
- Field reversible to F2 (except as noted)
- Encoder and brake provisions included on opposite drive end (maximum 10 lb-ft brake, see Modifications and/or Accessory Kits sections)
- UL Recognized, CSA Certified, and CE Mark
- Three year warranty



C-Face Footed (Rigid Base)

Suitable for use on VFD per guidelines on page 17.

HP	RPM	VOLTS	FRAME	OVER LOAD	CAT. NO.	MODEL NO.	STOCK	LIST PRICE	MULT. SYMB.	F.L. AMPS	WEIGHT	"C" DIM.	FOOT NOTES
1/4	1800	230/460	56C	TSTAT	Y592	056H17T2001	✓	\$373	E3	1.2/0.6	19	11.88	S,13
1/2	1800	230/460	56C	TSTAT	Y534	056H17T5301	✓	\$467	E3	1.6/0.8	35	13.48	S,6,13
	1800	575	56C	TSTAT	Y555	056H17T5311	✓	\$467	E3	0.6	35	13.48	S,6,13
1	1800	230/460	56C	TSTAT	Y535	056H17T5302	✓	\$557	E3	3.0/1.5	39	14.98	S,6,13
	1800	575	56C	TSTAT	Y556	056H17T5312	✓	\$557	E3	1.2	39	14.98	S,6,13
	1800	230/460	143TC	TSTAT	Y536	143THTR5326	✓	\$572	E3	3.0/1.5	48	15.04	S,6,13
	1200	230/460	145TC	TSTAT	Y537	145THTR5376	✓	\$663	E3	3.8/1.9	49	16.04	S,6,13
1 1/2	1800	230/460	145TC	TSTAT	Y538	145THTR5326	✓	\$695	E3	4.8/2.4	50	16.04	S,6,13
2	1800	230/460	145TC	TSTAT	Y612	145THTR16032	✓	\$895	E3	6.0/3.0	65	16.04	S,6,13
	1800	230/460	145TC	TSTAT	Y551	145THTN6046	✓	\$960	E3	6.0/3.0	73	14.68	
	1800	575	145TC	TSTAT	Y611	145THTR16031	✓	\$895	E3	2.4	65	16.04	S,6,13
	1800	575	145TC	TSTAT	Y557	145THTN6060	✓	\$960	E3	2.4	73	14.68	
	1200	230/460	184TC	TSTAT	Y540	184THTL7776	✓	\$1,373	E3	6.6/3.3	88	16.94	AL
3	1800	230/460	182TC	TSTAT	Y541	182THTL7726	✓	\$1,190	E3	8.4/4.2	95	17.39	d,AL
	1800	230/460	182TC	TSTAT	Y541A	182THTY7726	✓	\$1,190	E3	8.2/4.1	95	16.19	AL
	1800	575	182TC	TSTAT	Y558	182THTL7736	✓	\$1,190	E3	3.4	95	17.39	d,AL
	1800	575	182TC	TSTAT	Y558A	182THTY7736	✓	\$1,190	E3	3.4	95	16.19	AL
	1200	230/460	213TC	TSTAT	Y542	213THTL7776	✓	\$1,691	E3	9.4/4.7	105	19.94	AL
5	1800	230/460	184TC	TSTAT	Y543	184THTL7726	✓	\$1,421	E3	14.0/7.0	110	18.94	d,AL
	1800	230/460	184TC	TSTAT	Y543A	184THTY7726	✓	\$1,421	E3	13.4/6.7	110	17.69	AL
	1800	575	184TC	TSTAT	Y559	184THTL7736	✓	\$1,421	E3	5.6	110	18.94	d,AL
	1800	575	184TC	TSTAT	Y559A	184THTY7736	✓	\$1,421	E3	5.4	110	17.69	AL
	1200	230/460	215TC	TSTAT	Y544	215THTL7776	✓	\$2,057	E3	15.4/7.7	146	20.54	AL
7 1/2	1800	230/460	213TC	TSTAT	Y545	213THTL7726	✓	\$1,865	E3	21.0/10.5	146	20.54	AL
	1800	575	213TC	TSTAT	Y560	213THTL7736	✓	\$1,865	E3	8.4	146	20.54	AL
	1200	230/460	254TC	TSTAT	Y546	254THTL5776	✓	\$2,767	E3	22.0/11.0	223	25.37	AL,I
10	1800	230/460	215TC	TSTAT	Y547	215THTL7726	✓	\$2,231	E3	27.0/13.5	219	23.04	AL
	1800	575	215TC	TSTAT	Y561	215THTL7736	✓	\$2,231	E3	10.8	219	23.04	AL
	1200	230/460	256TC	TSTAT	Y548	256THTL5776	✓	\$3,132	E3	28.0/14.0	229	26.87	AL,I
15	1800	230/460	254TC	TSTAT	Y549	254THTL5726	✓	\$2,655	E3	40.0/20.0	260	26.87	AL,I
	1800	575	254TC	TSTAT	Y562	254THTL5736	✓	\$2,655	E3	16.0	260	26.87	AL,I

Contact Marathon for other base speeds and options not shown in this catalog.

Blue shaded areas are Cast Iron Frames

Continued on next page.

Inverter (Vector) Duty: Black Max® 1000:1 Constant Torque, TENV, Three Phase

C-Face Footed (Rigid Base)

HP	RPM	VOLTS	FRAME	OVER LOAD	CAT. NO.	MODEL NO.	STOCK	LIST PRICE	MULT. SYMB.	F.L. AMPS	WEIGHT	"C" DIM.	FOOT NOTES
20	1800	230/460	256TC	TSTAT	Y552	256THTNA7026	✓	\$3,876	E3	52.0/26.0	300	27.13	
	1800	575	256TC	TSTAT	Y563	256THTNA7036	✓	\$3,876	E3	20.8	300	27.13	
25	1800	230/460	284TC	TSTAT	Y553	284THTNA7026	✓	\$4,216	E3	62.0/31.0	379	27.08	I
	1800	575	284TC	TSTAT	Y567	284THTNA7036		\$4,216	E3	24.8	379	27.08	I
30	1800	230/460	286TC	TSTAT	Y393	286THTNA7026	✓	\$4,754	E3	74.0/37.0	575	28.58	I
	1800	575	286TC	TSTAT	Y394	286THTNA7036		\$4,754	E3	29.6	575	28.58	I

Contact Marathon for other base speeds and options not shown in this catalog.

Blue shaded areas are Cast Iron Frames

Inverter (Vector) Duty: Black Max® Hazardous Duty™ 1000:1 Constant Torque, Explosion Proof, Three Phase Class I and II (gases and dust), Groups C, D, F & G, TENV

Applications:

For use in material handling, machine tools, conveyors, crane & hoist, and other variable speed applications requiring up to 1000:1 constant torque speed range, to be installed in hazardous environments as defined by the motor's explosion proof class and group rating. Refer to the General Information sections contained in this catalog for information on explosion proof classifications. Consult the National Electrical Code and your local regulations for the proper selection of motors in hazardous locations.

Features:

- MAX GUARD® Class F insulation system
- Constant torque operation from 0 to base speed on vector drive
- Constant HP operation to twice base RPM
- Continuous duty at 40°C ambient
- Optimized for operation with IGBT inverter (NEMA Design A)
- Normally closed thermostats (one per phase, Class F)
- Ball Bearings
- Top mount (F3) conduit box included, shipped loose
- No Encoder Provisions provided
- Meets temperature code T3B
- UL listed, under file #E12044
- CSA certified, under file numbers LR47504 and LR21839
- Three year warranty



INVERTER DUTY "MAX" Family of Motors

C-Face Footed (Rigid Base)

Suitable for use on VFD per guidelines on page 17.

HP	RPM	VOLTS	FRAME	OVER LOAD	CAT. NO.	MODEL NO.	STOCK	LIST PRICE	MULT. SYMB.	F.L. AMPS	WEIGHT	"C" DIM.	FOOT NOTES
1/4	1800	230/460	56C	TSTAT	Y600	056H17E5301	✓	\$556	E3	1.1/0.55	26	11.97	
1/3	1800	230/460	56C	TSTAT	Y601	056H17E5302	✓	\$652	E3	1.2/0.6	26	11.97	
1/2	1800	230/460	56C	TSTAT	Y602	056H17E5303	✓	\$703	E3	1.6/0.8	31	12.47	
3/4	1800	230/460	56C	TSTAT	Y603	056H17E5304	✓	\$778	E3	2.4/1.2	38	13.47	
1	1800	230/460	56C	TSTAT	Y604	056H17E5305	✓	\$852	E3	3.0/1.5	43	13.97	

Contact Marathon for other base speeds and options not shown in this catalog.

Inverter (Vector) Duty: Blue Max® 2000

2000:1 Constant Torque, Totally Enclosed, Three Phase

Applications:

Designed for inverter or vector applications where up to a 2000:1 constant torque speed range is required. Typical uses include: material handling, machine tools, conveyors, crane and hoist, metal processing, test stands, pumps, compressors, textile processing, and other industrial machinery installed in dusty or dirty environments where cast iron construction is required.

Features:

- MAX GUARD® Class H insulation system
- Constant torque operation from 0 to base speed on vector drive, including TEFC (On Volts/Hertz drives, TEFC motors are limited to 20:1 constant torque)
- Constant HP operation to twice base speed (143-256 frame);
1.5 times base (all others)
- Optimized for operation with IGBT inverter
- C-Face foot mount through 100 HP, as noted
- Normally closed thermostats (one per phase, class F)
- Continuous duty at 40°C ambient
- 1.0 Service Factor ("B" rise on TEBC motors)
- Blue Chip quality, cast iron frame and brackets
- Patented "fracket" design (TEBC enclosure)
- Ball Bearings (roller bearing available 360 Frame & larger)
- Field reversible to F2
- Encoder provisions included on opposite drive end
(see Modification and/or Accessory Kits sections)
- UL Recognized, CSA Certified, and CE Mark
- Three year warranty



Rigid Base and C-Face Footed (Rigid Base)

Suitable for use on VFD per guidelines on page 17.

HP	RPM	VOLTS	ENCL	FRAME	CAT. NO.	MODEL NO.	STOCK	LIST PRICE	MULT. SYMB.	F.L. AMPS	WEIGHT	"C" DIM.	FOOT NOTES
1	1800	230/460	TENV	143TC	Y525	143THTN8028	✓	\$1,003	E3	3.0/1.5	61	13.68	B
1 1/2	1800	230/460	TENV	145TC	Y590	145THTN8037	✓	\$1,008	E3	4.6/2.3	65	14.68	
2	1800	230/460	TENV	145TC	Y526	145THTN8029	✓	\$1,086	E3	6.0/3.0	71	14.68	
3	1800	230/460	TENV	182TC	Y527	182THTS8028	✓	\$1,364	E3	8.0/4.0	113	16.68	
5	1800	230/460	TENV	184TC	Y564	184THTS8028	✓	\$1,525	E3	13.4/6.7	147	17.68	
7 1/2	1800	230/460	TEFC	213TC	Y595	213THFS8028	✓	\$1,784	E3	19.4/9.7	192	21.03	
	1800	230/460	TENV	213TC	Y565	213THTS8038	✓	\$2,055	E3	21.0/10.5	85	20.56	
10	1800	230/460	TEFC	215TC	Y596	215THFS8029	✓	\$2,132	E3	25.4/12.7	212	22.53	
	1800	230/460	TENV	215TC	Y566	215THTS8038	✓	\$2,437	E3	26.0/13.0	272	22.74	
15	1800	230/460	TEFC	254TC	Y597	254THFNA8038	✓	\$2,568	E3	37.0/18.5	350	26.34	
	1800	230/460	TENV	254TC	Y509	254THTNA8058	✓	\$2,917	E3	40.4/20.2	334	23.38	
	1200	230/460	TEBC	284TC	Y395	284THFPA8086		\$5,723	E3	40.0/20.0	500	37.48	BP
20	1800	230/460	TEFC	256TC	Y598	256THFNA8038	✓	\$2,841	E3	52.0/26.0	377	28.09	
	1800	230/460	TENV	256TC	Y510	256THTNA8038	✓	\$4,038	E3	52.0/26.0	425	27.13	
	1200	230/460	TEBC	286TC	Y582	286THFPA8086		\$7,399	E3	52.4/26.2	660	38.98	BP
25	1800	230/460	TEFC	284T	Y569	284THFPA8028	✓	\$3,548	E3	63.0/31.5	393	28.58	
	1800	230/460	TEBC	284TC	Y511	284THFPA8038	✓	\$4,959	E3	63.0/31.5	470	37.48	BP
	1200	230/460	TEBC	324TC	Y583	324THFPA8086		\$8,703	E3	67.0/33.5	633	40.41	B,BP
30	1800	230/460	TEFC	286T	Y570	286THFNA8028	✓	\$4,056	E3	77.0/38.5	371	29.91	
	1800	230/460	TEBC	286TC	Y512	286THFPA8038	✓	\$5,467	E3	74.0/37.0	507	38.98	BP
	1200	230/460	TEBC	326TC	Y584	326THFPA8086		\$9,574	E3	80.4/40.2	550	41.91	B,BP
40	1800	230/460	TEFC	324T	Y571	324THFPA8028	✓	\$5,252	E3	100/50.0	545	30.71	
	1800	230/460	TEBC	324TC	Y513	324THFPA8038	✓	\$6,549	E3	100/50.0	531	40.41	BP
	1200	230/460	TEBC	364TC	Y585	364THFS8391		\$11,549	E3	107/53.5	1011	42.67	BP
50	1800	230/460	TEFC	326T	Y572	326THFS8028	✓	\$6,497	E3	121/60.5	765	32.44	
	1800	230/460	TEBC	326TC	Y514	326THFPA8038	✓	\$7,508	E3	120/60.0	686	41.91	BP
	1200	230/460	TEBC	365TC	Y586	365THFS8380		\$13,845	E3	130/65.0	1081	43.78	BP
60	1800	230/460	TEFC	364T	Y573	364THFS8036	✓	\$8,375	E3	147/73.5	987	33.70	
	1800	230/460	TEBC	364TC	Y515	364THFS8046	✓	\$9,191	E3	147/73.5	1062	42.67	BP
	1200	230/460	TEBC	404TC	Y587	404THFS8092		\$15,358	E3	142/71.0	1339	48.22	BP
75	1800	230/460	TEFC	365T	Y574	365THFS8036	✓	\$9,487	E3	184/92.0	1061	34.69	
	1800	230/460	TEBC	365TC	Y516	365THFS8046	✓	\$10,987	E3	180/90.0	1129	43.67	BP
	1200	230/460	TEBC	405TC	Y588	405THFS8378	✓	\$18,713	E3	180/90.0	1387	49.72	B,BP

Blue shaded areas are Cast Iron Frames

Continued on next page.

INVERTER DUTY "MAX" Family of Motors

Inverter (Vector) Duty: Blue Max® 2000 2000:1 Constant Torque, Totally Enclosed, Three Phase

Rigid Base and C-Face Footed (Rigid Base)

HP	RPM	VOLTS	ENCL	FRAME	CAT. NO.	MODEL NO.	STOCK	LIST PRICE	MULT. SYMB.	F.L. AMPS	WEIGHT	"C" DIM.	FOOT NOTES
100	1800	230/460	TEFC	405T	Y575	405THFS8036	✓	\$12,838	E3	230/115	1308	39.32	
	1800	230/460	TEBC	405TC	Y517	405THFS8046	✓	\$15,337	E3	230/115	1529	49.72	BP
	1200	230/460	TEBC	444TC	Y589	444THFN8384	✓	\$21,478	E3	250/125	2117	52.72	BP
125	1800	460	TEFC	444T	Y576	444THFN8036	✓	\$16,896	E3	143	2053	43.27	
	1800	460	TEBC	444T	Y518	444THFN8046	✓	\$19,545	E3	138	2010	52.72	B,BP
150	1800	460	TEFC	445T	Y577	445THFN8036	✓	\$19,507	E3	170	2247	45.27	
	1800	460	TEBC	445T	Y519	445THFN8046	✓	\$22,155	E3	170	2310	54.72	BP
200	1800	460	TEFC	445T	Y578	445THFN8040	✓	\$23,547	E3	230	2388	45.27	
	1800	460	TEBC	445T	Y520	445THFN8050	✓	\$26,195	E3	230	2430	54.72	BP
250	1800	460	TEFC	449T	Y579	449THFS8036	✓	\$29,330	E3	280	2900	53.89	CT
	1800	460	TEBC	449T	Y531	449THFS8046	✓	\$32,811	E3	295	2991	63.21	BP
300	1800	460	TEFC	449T	Y580	449THFS8037	✓	\$33,396	E3	330	3077	53.89	CT
	1800	460	TEBC	449T	Y532	449THFS8047	✓	\$36,876	E3	327	2950	63.21	BP
350	1800	460	TEBC	449T	Y533	449THFS8048	✓	\$40,358	E3	385	3099	63.21	BP

Inverter (Vector) Duty: Blue Max® 2000 Hazardous Duty™ (with Encoder) 2000:1 Constant Torque, Explosion Proof, Three Phase Class I and II (gases and dust), Groups C (as noted), D, F & G, TENV

Applications:

Designed for industrial applications with Vector Drives where up to a 2000:1 constant torque speed range and/or precise speed or torque regulation is required, including positioning equipment. Used in dirty, dusty or caustic environments where cast iron construction is required, and installed in hazardous environments as defined by the motor's explosion proof class and group rating. Consult the National Electrical Code and your local regulations for the proper selection of motors in hazardous locations.

Features:

- BEI H38 explosion proof encoder 1024 ppr, Class I Groups C & D, Class II Groups E, F, G included
- MAX GUARD® Class F insulation system
- Constant torque operation from 0 to base speed on vector drive
- Constant HP operation up to twice base speed
- Continuous duty at 40°C ambient
- Optimized for operation with IGBT inverter (NEMA Design A)
- Normally closed thermostats (one per phase, Class F)
- Ball Bearings
- Cast iron frame and brackets
- F1 standard, NOT field reversible to F2
- UL Listed File No. E12044, MC228275
- CSA Certified File No. LR47504, MC236833
- Meets temperature code T3B
- Three year warranty



INVERTER DUTY "MAX" Family of Motors

C-Face Footed (Rigid Base)

Suitable for use on VFD per guidelines on page 17.

HP	RPM	VOLTS	ENCL	FRAME	CAT. NO.	MODEL NO.	STOCK	LIST PRICE	MULT. SYMB.	F.L. AMPS	WEIGHT	"C" DIM.	FOOT NOTES
1	1800	230/460	143TC	TSTAT	Y978	143THEN8034	✓	\$5,810	E3	3.0/1.5	86	21.44	CD
2	1800	230/460	145TC	TSTAT	Y979	145THEN8034	✓	\$5,932	E3	5.8/2.9	90	21.44	CD
3	1800	230/460	182TC	TSTAT	Y980	182THES8048	✓	\$6,123	E3	8.2/4.1	117	24.82	CD
5	1800	230/460	213TC	TSTAT	Y981	213THES8053	✓	\$6,442	E3	13.0/6.5	240	27.42	
7 1/2	1800	230/460	254TC	TSTAT	Y982	254THEN8058	✓	\$7,326	E3	22/11	344	30.20	CD
10	1800	230/460	254TC	TSTAT	Y983	254THEN8059	✓	\$7,675	E3	27.0/13.5	376	30.20	CD
15	1800	230/460	256TC	TSTAT	Y984	256THEN17031	✓	\$8,024	E3	36.0/18.0	432	31.95	CD
20	1800	230/460	284TC	TSTAT	Y985	284THEN8032	✓	\$8,857	E3	53/26.5	555	33.16	CD

Blue shaded areas are Cast Iron Frames

Inverter (Vector) Duty: Blue Max® 2000 Brakemotors 2000:1 Constant Torque, TENV, Three Phase

Applications:

Designed for vector applications where up to a 2000:1 constant torque speed range is required. For use on Conveyors, Machine tools, Cranes, Hoists, and other industrial machinery requiring quick stop and/or holding torque.

Features:

- MAX GUARD® Class F insulation system
- Constant torque operation from 0 to base speed on vector drive
- Constant HP operation to twice base speed
- Optimized for operation with IGBT inverter (NEMA Design A)
- Normally closed thermostats (one per phase, Class F)
- Ball Bearings
- Continuous duty at 40°C ambient
- Will accept encoder through Mod Central (see mod 24 for encoder mounting)
- Stearns brakes, 56 series through 15 Lb-Ft, 87 series, 25 Lb-Ft and larger
- Includes 140% rated spring-set self-adjusting NEMA 2 disk brake (Brake coil voltage matches motor)
- Universal mounting up to 15 Lb-Ft, (see comment below and Mod Central for vertical mounting)
- Horizontal mounting (see comment below and Mod Central for vertical mounting)
- UL Recognized, CSA Certified, and CE Mark
- Three year warranty (brake disks are exempt)



C-Face Footed (Rigid Base)

Suitable for use on VFD per guidelines on page 17.

HP	RPM	VOLTS	FRAME	CAT. NO.	MODEL NO.	STOCK	LIST PRICE	MULT. SYMB.	F.L. AMPS	WEIGHT	"C" DIM.	TORQUE RATING (Lb/Ft)
1	1800	230/460	143TC	Y986	143THTN8036	✓	\$1,813	E3	3.0/1.5	72	17.00	6
2	1800	230/460	145TC	Y987	145THTN8043	✓	\$2,019	E3	6.0/3.0	83	18.00	10
3	1800	230/460	182TC	Y988	182THTS8048	✓	\$2,644	E3	8.2/4.1	118	19.67	15
5	1800	230/460	184TC	Y989	184THTS8056	✓	\$3,187	E3	13.4/6.7	161	25.58	25
7 1/2	1800	230/460	213TC	Y990	213THTS8071	✓	\$3,994	E3	21.0/10.5	256	27.58	35
10	1800	230/460	215TC	Y991	215THTS8071	✓	\$4,746	E3	26.0/13.0	302	28.83	50
15	1800	230/460	254TC	Y992	254THTNA8071	✓	\$6,031	E3	40.5/20.2	384	31.53	75
20	1800	230/460	256TC	Y993	256THTNA8071	✓	\$7,994	E3	52.0/26.0	427	33.28	105

Blue shaded areas are Cast Iron Frames

1024 ppr Encoders through MOD Central

Multiplier Symbol E3

BRAND	MODEL	CAT. NO.	KIT NUMBER	STOCK	LIST (KIT ONLY)	LIST (INSTALLED)	FITS BRAKEMOTOR CAT. NO.	WEIGHT
Avtron	AV56	A748	KIT M561024BRK-140	✓	\$2,283	\$2,619	Y986, Y987	4
		A749	KIT M561024BRK-182	✓	\$2,283	\$2,619	Y988	4
	AV85	A750	KIT M851024BRK-184	✓	\$3,080	\$3,416	Y989	5
		A751	KIT M851024BRK-210	✓	\$3,080	\$3,416	Y990, Y991	8
NorthStar	ST56	A752	KIT M851024BRK-250	✓	\$3,080	\$3,416	Y992, Y993	8
		A786	KIT LKSR-CFACE	✓	\$2,510	\$2,846	Y986, Y987	4
	ST85	A789	KIT SL561024-182NV	✓	\$2,510	\$2,846	Y988	4
		A790	KIT SL851024-184NV	✓	\$3,080	\$3,416	Y989	8
		A791	KIT SL851024-210NV	✓	\$3,080	\$3,416	Y990, Y991	8
		A792	KIT SL851024-250NV	✓	\$3,080	\$3,416	Y992, Y993	8

Vertical Modification Kit (Stearns 87,000 series)

Includes required hardware to accommodate vertical above (shaft down) or vertical below (shaft up) mounting.

TORQUE RATING (Lb/Ft)	MOUNTING		CAT. NO.	STOCK	MODEL NO.	LIST (KITS ONLY)	LIST INSTALLED	WEIGHT
	SHAFT UP	SHAFT DOWN						
25,35	Not req'd	Required	A157	✓	KIT VRT87BRK	\$420	\$552	3
50,75,105	Required	Required						

SyMax™ Permanent Magnet AC Motors

TENV and TEFC Three Phase



Commercial, Rolled Steel frame (NEMA 56 frame models)

Features:

- Meets or exceeds NEMA Premium® (IE3)
- Class F MAX GUARD® insulation system
- Operational to 20:1 Constant Torque open-loop (1000:1 closed-loop)
- IP43 ingress protection (IP54 or IP55 available)
- Totally Enclosed, Non-Ventilated
- Sealed ball bearing
- High power density, low weight design
- Provisions for optional "BCP" (Bearing Current Protection)
- Three year warranty
- Requires Drive for Operation



Industrial, Cast Iron frame (NEMA 182-286T frame models)

Features:

- Ultra Efficient™ Premium-Plus exceeds NEMA Premium® (IE4)
- Class H MAX GUARD® insulation system
- Cast iron construction for rigidity and reduced vibration
- IP54 ingress protection (IP55 or IP56 available)
- Premium Severe Duty, TEFC
- Normally closed thermostats (one per phase, Class F)
- High power density, low weight design
- UL, CSA and CE
- Optional terminal block shown
- Provisions for optional "BCP" (Bearing Current Protection)
- Three year warranty
- Requires Drive for Operation

HP	RPM	VOLTS	NEMA FRAME	TORQUE (LB-FT)	CAT. NO.	MODEL NO.	STOCK	LIST PRICE	MULT. SYMB.	NOM. EFF.	F.L. AMPS	WEIGHT	"C" DIM.	FOOT NOTES
1/2	1800	230/460	56C	1.5	SY001	056PNRA10100	✓	\$671	PM1	83.5	1.86/0.93	13	7.68	N
1	1800	230/460	56C	2.9	SY003	056PNRA10101	✓	\$780	PM1	85.3	3.55/1.78	18	8.68	N
1 1/2	1800	230/460	56C	4.4	SY004	056PNRA10102	✓	\$950	PM1	86.1	5.48/2.74	23	9.68	N
2	1800	230/460	56C	5.8	SY005	056PNRA10103	✓	\$1,275	PM1	86.5	6.32/3.16	28	10.68	N
3	1800	460	182TC	8.8	SY006	182TPFSA10094	✓	\$2,056	PM1	91.7	3.8	99	16.63	
5	1800	460	184TC	14.6	SY007	184TPFSA10095	✓	\$2,281	PM1	91.7	6.4	108	16.63	
7.5	1800	460	213TC	21.9	SY008	213TPFSA10096	✓	\$2,648	PM1	93.0	9.4	152	20.16	
10	1800	460	215TC	29.2	SY009	215TPFSA10097	✓	\$3,136	PM1	93.6	11.8	166	20.16	
15	1800	460	254TC	43.8	SY010	254TPFSA10088	✓	\$3,798	PM1	94.5	18.5	204	25.77	
20	1800	460	256TC	58.3	SY011	256TPFSA10087	✓	\$4,346	PM1	95.0	22.9	253	25.77	
25	1800	460	284TC	72.9	SY012	284TPFSA10112	✓	\$5,288	PM1	95.0	28.1	396	26.21	
30	1800	460	286TC	87.5	SY013	286TPFSA10090	✓	\$6,001	PM1	95.4	33.7	416	27.71	

Catalog numbers (Cat No.) highlighted in bold blue have efficiency levels that meet EISA requirements

Blue shaded areas are Cast Iron Frames

INVERTER DUTY "MAX" Family of Motors

DC Permanent Magnet SCR Rated, Totally Enclosed C-Face Footed (Removable Base)

Features:

- Class F insulation
- NEMA C-Face with removable rigid base
- Oversized brushes for extra long life
- Permanently lubricated sealed ball bearings
- Linear speed/torque characteristics over entire speed range
- High starting torque, high peak current capability
- Usable on PWM type DC adjustable speed drives at higher HP rating
- Easy brush access with unique brush holder design
- UL Recognized and CSA Certified



HP	RPM	DC VOLTS	FRAME	ENCL.	CAT. NO.	MODEL NO.	STOCK	LIST PRICE	MULT. SYMB.	C.T. SPEED RANGE	F.L. AMPS	PWM HP RATING	WEIGHT	"C" DIM.	FOOT NOTES
1/4	1750	90	56C	TEFC	Z602	056E17F1001	✓	\$498	D1	2:1	2.5	0.40	22	10.81	
	1750	180	56C	TEFC	Z603	056E17F1002	✓	\$498	D1	2:1	1.4	0.50	22	11.31	
1/3	1750	90	56C	TEFC	Z604	056E17F1003	✓	\$528	D1	2:1	3.5	0.50	24	11.31	
	1750	180	56C	TEFC	Z605	056E17F1004	✓	\$528	D1	2:1	1.7	0.50	22	11.31	d
1/2	1750	90	56C	TEFC	Z606	056E17F1005	✓	\$588	D1	2:1	5.0	0.70	26	11.81	
	1750	180	56C	TEFC	Z607	056E17F1006	✓	\$588	D1	2:1	2.5	0.56	25	11.81	
3/4	1750	90	56C	TEFC	Z610	056E17F1007	✓	\$714	D1	2:1	7.6	1.00	34	13.81	
	1750	180	56C	TEFC	Z611	056E17F1008	✓	\$714	D1	2:1	3.8	1.00	34	13.81	
1	1750	90	56C	TEFC	Z612	056E17F2005	✓	\$872	D1	2:1	10.0	1.25	45	14.81	
	1750	180	56C	TEFC	Z613	056E17F2006	✓	\$872	D1	2:1	5.0	1.25	41	14.81	
1 1/2	1750	180	56C	TEFC	Z614	056E17F2007	✓	\$1,090	D1	2:1	7.6	1.75	52	16.81	
	1750	180	145TC	TEFC	Z615	145TEFR5326	✓	\$1,656	D1	2:1	7.5	1.50	74	18.34	
2	1750	180	145TC	TEFC	Z616	145TEFR5327	✓	\$1,975	D1	2:1	9.5	2.00	86	19.34	
	1750	180	182/145TC	TEFC	Z617	182TEFR5326	✓	\$1,975	D1	2:1	9.5	2.00	83	19.34	84



SCR PMDC motors on PWM power supplies

Pulse width modulated DC controls have a voltage output similar to pure direct current which has a form factor of 1.05. SCR thyristor drives have a form factor of 1.40. Marathon Motors's non-Explosion Proof PMDC, SCR-rated motors can also be used with PWM controls, and due to the lower form factor and the resultant lower heating in the motor, their rating can be increased as indicated above. Operation on PWM controls will also result in quieter operation and longer brush life.

Washdown, DC Permanent Magnet SCR Rated, Totally Enclosed C-Face Footed (Removable Base)

Features:

- Class F insulation
- NEMA C-Face with removable rigid base
- Oversized brushes for extra long life
- Doubled sealed, oversized ball bearings
- Corrosion resistant 303 stainless steel shaft
- "V" ring Forsheda seals
- High temperature, moisture resistant lubricant
- Exterior and interior components protected with enamel & polyester compounds
- Aluminum conduit box, threaded and gasketed
- Drains at 3:00, 6:00, 9:00 and 12:00 locations
- Sealed machine fits
- Stainless steel nameplate
- USDA approved white epoxy paint
- UL Recognized and CSA Certified



HP	RPM	DC VOLTS	FRAME	ENCL.	CAT. NO.	MODEL NO.	STOCK	LIST PRICE	MULT. SYMB.	C.T. SPEED RANGE	F.L. AMPS	PWM HP RATING	WEIGHT	"C" DIM.	FOOT NOTES
1/4	1750	90	56C	TENV	Z630	056E17V2001	✓	\$639	D1	20:1	2.7	0.30	24	10.69	
1/3	1750	90	56C	TENV	Z631	056E17V2002		\$676	D1	20:1	3.5	0.56	30	11.69	
1/2	1750	90	56C	TENV	Z634	056E17V2003	✓	\$757	D1	20:1	4.9	0.75	37	13.69	
		180	56C	TENV	Z635	056E17V2004	✓	\$757	D1	20:1	2.4	0.70	41	13.69	d
3/4	1750	90	56C	TENV	Z636	056E17V2005	✓	\$918	D1	20:1	7.0	1.25	51	14.67	
		180	56C	TENV	Z637	056E17V2006		\$918	D1	20:1	3.5	1.25	50	14.17	
1	1750	90	56C	TEFC	Z638	056E17W2001	✓	\$1,120	D1	2:1	10.0	1.25	45	14.81	
		180	56C	TEFC	Z639	056E17W2002	✓	\$1,120	D1	2:1	5.0	1.25	41	14.81	
1 1/2	1750	180	56C	TEFC	Z641	056E17W2003		\$1,430	D1	2:1	7.6	1.75	51	16.81	

Low Voltage, DC Permanent Magnet TENV and TEFC C-Face Footed (Removable Base)

Features:

- Permanently lubricated sealed ball bearings
- NEMA C-Face with removable base
- Class H insulation
- Easy brush access with unique brush holder design
- Oversized brushes for extra long life
- High starting torque
- U.L. Recognized and CSA Certified

Applications

Low voltage permanent magnet DC motors are suitable for installations having batteries or generator supplied low voltage DC.



HP	RPM	DC VOLTS	FRAME	ENCL.	CAT. NO.	MODEL NO.	STOCK	LIST PRICE	MULT. SYMB.	F.L. AMPS	WEIGHT	"C" DIM.	FOOT NOTES
1/4	1750	12	56C	TENV	Z660	056E17T2001	✓	\$535	D1	21.0	22	10.27	85
1/3	1750	12	56C	TENV	Z662	056E17T2002	✓	\$589	D1	27.0	24	10.77	d,85
		24	56C	TENV	Z663	056E17T2003	✓	\$563	D1	13.5	23	10.77	85
1/2	1750	12	56C	TENV	Z664	056E17T2004	✓	\$612	D1	39.0	30	11.77	85
		24	56C	TENV	Z665	056E17T2005		\$585	D1	20.0	28	11.77	85
3/4	1750	12	56C	TEFC	Z666	056E17F2008	✓	\$676	D1	58.0	35	13.81	
		24	56C	TEFC	Z667	056E17F2009	✓	\$611	D1	29.0	32	12.81	85
1	1750	12	56C	TEFC	Z668	056E17F2010	✓	\$805	D1	80.0	39	13.81	
		24	56C	TEFC	Z669	056E17F2011	✓	\$742	D1	39.0	34	13.81	85
1 1/2	1750	24	56C	TEFC	Z670	056E17F2014	✓	\$897	D1	60	53	17.38	85
		24	56C	TEFC	Z671	056E17F2015	✓	\$1,086	D1	70	68	16.74	85

Globetrotter® IEC (Metric) Frame, Three Phase

Totally Enclosed, B3 Mounting, Rigid Base

Applications:

For use on fans, pumps, compressors, conveyors, and other equipment requiring IEC dimensions and electrical standards. The Globetrotter is not only designed to International standards but meets NEMA performance and efficiency standards making it suitable for requirements worldwide.

Features:

- Meets IE3 European and NEMA Premium® efficiencies
- Aluminum (63-90 frame) or Cast Iron (100-315 frame) frame construction
- Nameplated 60/50 hertz at same HP, above 90 frame is 60/50 Hz at next lower HP
- MAX GUARD® Class F Insulation, Class B rise @ rated KW
- IP55 weatherproof enclosure
- Rotatable/Removable Base (63-90 frame)
- Wye Start-Delta Run on 160 Frame and larger
- 10:1 Variable Torque, Constant Torque speed range as noted
- Top Mounted/Oversized gasketed terminal box
- Meets IEEE45, IEC60092 & USCG CFR46 Marine Duty (63-90 frame "Below Deck")



- 1.15 Service Factor on 60 Hz sine wave, 1.0 SF or VFD
- IEC Design "N" with NEMA "B" Torques
- Terminal Blocks, Stud Type, Zero Creepage
- Kits or MOD Central for B3/B14 mounting, see Accessories section
- Meets IEC 34 electrical standards
- Meets IEC 72 dimensions and tolerances
- CE Marked
- 1 Year Warranty

CONSULT
MARATHON MOTORS
FOR SPECIAL IEC
MOTORS

Multiplier Symbol F4

Suitable for use on VFD per guidelines on page 17.

HP/ kW	RPM 60/50 HZ	60 HZ VOLTS	50 HZ VOLTS	IEC FRAME	CAT. NO.	MODEL NO.	STOCK	C.T. SPEED RANGE*	LIST PRICE	NOM. EFF.	60 HZ F.L. AMPS	WEIGHT	IEC "L" DIM. (mm)	FOOT NOTES	B5/FF FLANGE
1/4-.18	3600/3000	230/460	200/400	63	R300	63T34FH5301	√	20:1	\$187	72.0	0.8/0.4	11	217		A569
	3600/3000	575	480	63	R400	63T34FH5303	√	20:1	\$187	72.0	0.3	11	217		A569
	1800/1500	230/460	200/400	63	R301	63T17FH5326	√	20:1	\$195	68.0	1.0/0.5	12	217		A569
	1800/1500	575	480	63	R401	63T17FH5327	√	20:1	\$195	68.0	0.4	12	217		A569
	1200/1000	230/460	200/400	71	R302	71T11FH5376	√	20:1	\$332	64.0	1.2/0.6	13	240		A570
1/3-.25	3600/3000	230/460	200/400	63	R303	63T34FH5302	√	20:1	\$219	72.0	1.1/55	12	217		A569
	3600/3000	575	480	63	R403	63T34FH5304	√	20:1	\$219	72.0	0.4	12	217		A569
	1800/1500	230/460	200/400	71	R304	71T17FH5326	√	20:1	\$228	68.0	1.4/7	14	240		A570
	1800/1500	575	480	71	R404	71T17FH5330	√	20:1	\$228	68.0	0.6	14	240		A570
	1200/1000	230/460	200/400	80	R305	80T11FH5376	√	20:1	\$357	70.0	1.3/65	20	282		A571
1/2-.37	3600/3000	230/460	200/400	71	R306	71T34FH5301	√	20:1	\$233	74.0	1.6/8	14	240		A570
	3600/3000	575	480	71	R406	71T34FH5303	√	20:1	\$233	74.0	0.7	14	240		A570
	1800/1500	230/460	200/400	71	R307	71T17FH5327	√	20:1	\$237	74.0	1.8/9	15	240		A570
	1800/1500	575	480	71	R407	71T17FH5331	√	20:1	\$237	74.0	0.7	16	240		A570
	1200/1000	230/460	200/400	80	R308	80T11FH5377	√	20:1	\$372	72.0	1.9/95	22	282		A571
3/4-.55	3600/3000	230/460	200/400	71	R309	71T34FH5302	√	20:1	\$245	74.0	2.4/1.2	16	240		A570
	3600/3000	575	480	71	R409	71T34FH5304	√	20:1	\$245	74.0	0.9	16	240		A570
	1800/1500	230/460	200/400	80	R310	80T17FH5326	√	20:1	\$258	74.0	2.5/1.25	21	282		A571
	1800/1500	575	480	80	R410	80T17FH5330	√	20:1	\$258	74.0	1.0	22	282		A571
	1200/1000	230/460	200/400	80	R311	80T11FH5378	√	20:1	\$400	72.0	2.7/1.35	25	282		A571
1-.75	3600/3000	230/460	200/400	80	R312	80T34FH5301	√	20:1	\$278	75.5	2.8/1.4	24	282		A571
	3600/3000	575	480	80	R412	80T34FH5305	√	20:1	\$278	75.5	1.1	24	282		A571
	1800/1500	230/460	200/400	80	R313	80T17FH5327	√	20:1	\$282	80.0	3.2/1.6	29	282		A571
	1800/1500	575	480	80	R413	80T17FH5331	√	20:1	\$282	80.0	1.4	28	282		A571
	1200/1000	230/460	200/400	90S	R314A	90ST11FH6376	√	20:1	\$486	82.5	3.3/1.7	39	326		A572
1 1/2-1.1	3600/3000	230/460	200/400	80	R315	80T34FH5302	√	20:1	\$287	84.0	4.0/2.0	30	282		A571
	3600/3000	575	480	80	R415	80T34FH5303	√	20:1	\$287	84.0	1.6	29	282		A571
	1800/1500	230/460	200/400	90S	R316A	90ST17FH6326	√	20:1	\$369	86.5	4.6/2.3	40	326		A572
	1800/1500	575	480	90S	R416A	90ST17FH6327	√	20:1	\$369	86.5	1.8	43	326		A572
	1200/1000	230/460	200/400	100L	R317	100LTFC6586	√	2:1	\$576	87.5	5.5/10	82	380		A554A
2-1.5	3600/3000	230/460	200/400	90S	R318A	90ST34FH6301	√	20:1	\$384	85.5	5.2/2.6	37	326		A572
	3600/3000	575	480	90S	R418A	90ST34FH6302	√	20:1	\$384	85.5	2.1	37	326		A572
	1800/1500	230/460	200/400	90L	R319A	90LT17FH6326	√	20:1	\$396	86.5	5.8/2.9	44	326		A572
	1800/1500	575	480	90L	R419A	90LT17FH6327	√	20:1	\$396	86.5	2.4	44	326		A572
	1200/1000	230/460	200/400	100L	R320A	100LTFC6576	√	2:1	\$619	88.5	7.6/3.8	99	415		A554A
1200/1000	575	480	100L	R420A	100LTFC6577	√	2:1	\$619	87.5	2.1	98	415		A554A	

Catalog numbers (Cat No.) highlighted in bold blue have efficiency levels that meet EISA requirements

Blue shaded areas are Cast Iron Frames

* Requires nameplate modification

Continued on next page.

Globetrotter® IEC (Metric) Frame, Three Phase Totally Enclosed, B3 Mounting, Rigid Base

Multiplier Symbol F4

IEC MOTORS

HP/ kW	RPM 60/50 HZ	60 HZ VOLTS	50 HZ VOLTS	IEC FRAME	CAT. NO.	MODEL NO.	STOCK	C.T. SPEED RANGE*	LIST PRICE	NOM. EFF.	60 HZ F.L. AMPS	WEIGHT	IEC "L" DIM. (mm)	FOOT NOTES	B5/FF FLANGE	
3-2.2	3600/3000	230/460	200/400	90L	R321A	90LT34FH6301	✓	20:1	\$553	86.5	7.2/3.6	42	326		A572	
	3600/3000	575	480	90L	R421A	90LT34FH6302	✓	20:1	\$553	86.5	2.9	42	326		A572	
4-3	1800/1500	230/460	200/400	100L	R322A	100LTFC6526	✓	20:1	\$600	89.5	9.0/4.5	84	415		A554A	
	1800/1500	575	480	100L	R422A	100LTFC6527	✓	20:1	\$600	89.5	3.6	84	415		A554A	
	1200/1000	230/460	200/400	112M	R323A	112MTFC6576	✓	20:1	\$874	89.5	9.0/4.5	100	468		A554A	
	3600/3000	230/460	200/400	100L	R351A	100LTFC6501	✓	20:1	\$640	87.5	9.2/4.6	71	415		A554A	
5 1/2-4	3600/3000	575	480	100L	R451A	100LTFC6502	✓	20:1	\$640	87.5	3.7	71	415		A554A	
	1800/1500	230/460	200/400	100L	R352A	100LTFC6536	✓	20:1	\$651	89.5	11.0/5.5	84	415		A554A	
	1800/1500	575	480	100L	R452A	100LTFC6537	✓	20:1	\$651	89.5	4.4	84	415		A554A	
	1200/1000	230/460	200/400	132S	R353A	132STFC6586	✓	2:1	\$1,058	89.5	13.0/6.5	154	464		A556A	
7 1/2-5.5	3600/3000	230/460	200/400	112M	R324A	112MTFC6511	✓	20:1	\$824	87.5	12.8/6.4	104	410		A555B	
	3600/3000	575	480	112M	R424A	112MTFC6512	✓	20:1	\$824	87.5	5.1	104	410		A555B	
	1800/1500	230/460	200/400	112M	R325A	112MTFC6536	✓	20:1	\$794	89.5	14.0/7.0	104	410		A555B	
	1800/1500	575	480	112M	R425A	112MTFC6537	✓	20:1	\$794	89.5	5.6	104	410		A555B	
10-7.5	1200/1000	230/460	200/400	132M	R326A	132MTFC6586	✓	2:1	\$1,221	89.5	17/8.5	176	502		A556A	
	3600/3000	230/460	200/400	132S	R327A	132STFC6501	✓	20:1	\$1,033	90.2	17.6/8.8	152	464		A550	
	3600/3000	575	480	132S	R427A	132STFC6503	✓	20:1	\$1,033	90.2	7.0	152	464		A550	
	1800/1500	230/460	200/400	132S	R328A	132STFC6526	✓	20:1	\$998	91.7	19.6/9.8	150	464		A556A	
15-11	1800/1500	575	480	132S	R428A	132STFC6527	✓	20:1	\$998	91.7	7.8	105	464		A556A	
	1200/1000	230/460	200/400	132M	R329A	132MTFC6587	✓	2:1	\$1,469	91.0	23.4/11.7	180	502		A556A	
	3600/3000	230/460	200/400	132S	R330A	132STFC6502	✓	20:1	\$1,105	90.2	23.2/11.6	163	464		A550	
	3600/3000	575	480	132S	R430A	132STFC6504	✓	20:1	\$1,105	90.2	9.3	163	464		A550	
20-15	1800/1500	230/460	200/400	132M	R331A	132MTFC6536	✓	2:1	\$1,225	91.7	26.0/13.0	174	502		A556A	
	1800/1500	575	480	132M	R431A	132MTFC6537	✓	2:1	\$1,225	91.7	10.4	174	502		A556A	
	1200/1000	230/460	200/400	160M	R332A	160MTFC6586	✓	2:1	\$1,905	91.0	28.0/14.0	251	615	YD	A557	
	3600/3000	230/460	200/400	160M	R333A	160MTFC6511	✓	2:1	\$1,790	91.7	35.2/17.6	260	600	YD	A551	
25-18.5	1800/1500	230/460	200/400	160M	R334A	160MTFC6536	✓	10:1	\$1,756	92.4	37.8/18.9	264	600	YD	A557	
	1200/1000	230/460	200/400	160L	R335A	160LTFC6588	✓	2:1	\$2,445	91.7	38.8/19.4	330	675	YD	A557	
	3600/3000	230/460	200/400	160M	R336A	160MTFC6512	✓	10:1	\$2,100	91.7	46.8/23.4	269	600	YD	A551	
	1800/1500	230/460	200/400	160L	R337A	160LTFC6538	✓	2:1	\$2,214	93.0	47.0/23.5	311	600	YD	A557	
30-22	1200/1000	230/460	200/400	180L	R338A	180LTFC6588	✓	2:1	\$3,429	91.7	54.0/27.0	385	718	YD	A558	
	25-18.5	3600/3000	230/460	200/400	160L	R339A	160LTFC6513	✓	2:1	\$2,556	91.7	57.6/28.8	319	645	YD	A551
	1800/1500	230/460	200/400	180M	R340A	180MTFC6536	✓	20:1	\$2,814	93.6	59.2/29.6	381	680	YD	A558	
	1200/1000	230/460	200/400	200L	R341A	200LTFC6588	✓	2:1	\$4,300	93.0	63.0/31.5	467	775	YD	A559	
40-30	30-22	3600/3000	230/460	200/400	180M	R342A	180MTFC6511	✓	2:1	\$3,038	92.4	68.8/34.4	355	680	YD	A552
	1800/1500	230/460	200/400	180L	R343A	180LTFC6538	✓	20:1	\$3,163	93.6	69.2/34.6	427	718	YD	A558	
	1200/1000	230/460	200/400	200L	R344A	200LTFC6589	✓	2:1	\$4,871	93.0	76/38	467	750	YD	A559	
	40-30	3600/3000	230/460	200/400	200L	R345A	200LTFC6511	✓	20:1	\$4,325	92.4	89.6/44.8	522	750	YD	A553
50-37	1800/1500	230/460	200/400	200L	R346A	200LTFC6538	✓	2:1	\$4,656	94.1	95/47.5	531	750	YD	A559	
	1200/1000	230/460	200/400	225M	R347A	225MTFC6586	✓	2:1	\$7,319	94.1	100/50	633	837	YD	A580	
	50-37	3600/3000	230/460	200/400	200L	R348A	200LTFC6513	✓	10:1	\$5,673	93.0	111/55.7	546	750	YD	A553
	1800/1500	230/460	200/400	225S	R349A	225STFC6526	✓	10:1	\$6,460	94.5	117/58.8	632	812	YD	A580	
60-45	1200/1000	230/460	200/400	250M	R350A	250MTFC6586	✓	2:1	\$10,259	94.1	125/62.5	655	1350	YD	A594	
	60-45	3600/3000	230/460	200/400	225M	R500	225MTFC6501	✓	10:1	\$8,794	94.1	134/67.0	590	837	YD	A580
	1800/1500	230/460	200/400	225M	R501	225MTFC6526	✓	10:1	\$9,708	95.0	138/69.0	1005	837	YD	A580	
	1200/1000	230/460	200/400	280S	R502	280STFC6586	✓	2:1	\$12,954	95.0	152/76.0	975	975	YD	A596	
75-55	75-55	3600/3000	230/460	200/400	250M	R503	250MTFC6501	✓	2:1	\$12,069	93.6	170/85.0	937	1350	YD	A594
	1800/1500	230/460	200/400	250M	R504	250MTFC6526	✓	2:1	\$11,361	95.4	174/87.0	1030	922	YD	A594	
	1200/1000	230/460	200/400	280M	R505	280MTFC6588	✓	2:1	\$14,278	94.5	190/95.0	1100	1026	YD	A596	
	100-75	3600/3000	230/460	200/400	280S	R506	280STFC6501	✓	2:1	\$14,435	94.1	222/111	1016	975	YD	A596
100-75	1800/1500	230/460	200/400	280S	R507	280STFC6526	✓	2:1	\$13,118	95.4	226/113	1025	975	YD	A596	
	1200/1000	230/460	200/400	315S	R508	315STFC6588	✓	2:1	\$17,882	95.0	234/117	1300	1240	YD	A598	

Catalog numbers (Cat No.) highlighted in bold blue have efficiency levels that meet EISA requirements

Blue shaded areas are Cast Iron Frames

* Requires nameplate modification

Continued on next page.

Globetrotter® IEC (Metric) Frame, Three Phase Totally Enclosed, Flange/Base Mounting



B3/B5 "FF" (D-Flange)

Multiplier Symbol F4

HP/ kW	RPM 60/50 HZ	60 HZ VOLTS	50 HZ VOLTS	IEC FRAME	CAT. NO.	MODEL NO.	STOCK	C.T. SPEED RANGE†	LIST PRICE	NOM. EFF.	60 HZ F.L. AMPS	WEIGHT	IEC "L" DIM. (mm)	FOOT NOTES
1/4-.18	3600/3000	230/460	200/400	63D	R380	63T34FH5501	✓	20:1	\$215	72.0	0.8/0.4	10	217	
	1800/1500	230/460	200/400	63D	R381	63T17FH5502	✓	20:1	\$222	68.0	1.0/0.5	11	217	
	1200/1000	230/460	200/400	71D	R382	71T11FH5503	✓	20:1	\$382	64.0	1.2/0.6	12	240	
1/3-.25	3600/3000	230/460	200/400	63D	R383	63T34FH5504	✓	20:1	\$249	72.0	1.1/1.55	11	217	
	1800/1500	230/460	200/400	71D	R384	71T17FH5505	✓	20:1	\$257	68.0	1.4/1.7	13	240	
	1200/1000	230/460	200/400	80D	R385	80T11FH5506	✓	20:1	\$410	70.0	1.3/1.65	17	282	
1/2-.37	3600/3000	230/460	200/400	71D	R386	71T34FH5507	✓	20:1	\$255	74.0	1.6/1.8	13	240	
	1800/1500	230/460	200/400	71D	R387	71T17FH5508	✓	20:1	\$264	74.0	1.8/1.9	14	282	
	1200/1000	230/460	200/400	80D	R388	80T11FH5509	✓	20:1	\$427	72.0	1.9/1.95	19	282	
3/4-.55	3600/3000	230/460	200/400	71D	R389	71T34FH5510	✓	20:1	\$270	74.0	2.4/1.2	15	282	
	1800/1500	230/460	200/400	80D	R390	80T17FH5511	✓	20:1	\$288	74.0	2.5/1.25	18	282	
	1200/1000	230/460	200/400	80D	R391	80T11FH5512	✓	20:1	\$452	72.0	2.7/1.35	22	320	
1-.75	3600/3000	230/460	200/400	80D	R392	80T34FH5513	✓	20:1	\$297	75.5	2.8/1.4	21	282	
	1800/1500	230/460	200/400	80D	R393	80T17FH5514	✓	20:1	\$311	80.0	3.2/1.6	26	282	
	1200/1000	230/460	200/400	90SD	R394A	90ST11FH6515	✓	20:1	\$556	82.5	3.3/1.7	35	320	
1 1/2-1.1	3600/3000	230/460	200/400	80D	R395	80T34FH5516	✓	20:1	\$339	84.0	4.0/2.0	30	282	
	1800/1500	230/460	200/400	90SD	R396A	90ST17FH6517	✓	20:1	\$403	86.5	4.6/2.3	37	320	
2-1.5	3600/3000	230/460	200/400	90SD	R397A	90ST34FH6518	✓	20:1	\$439	85.5	5.2/2.6	33	320	
	1800/1500	230/460	200/400	90LD	R398A	90LT17FH6519	✓	20:1	\$451	86.5	5.8/2.9	38	320	
3-2.2	3600/3000	230/460	200/400	90LD	R399A	90LT34FH6520	✓	20:1	\$621	86.5	7.2/3.6	39	320	



B3/B14 "FT" (C-Face)

HP/ kW	RPM 60/50 HZ	60 HZ VOLTS	50 HZ VOLTS	IEC FRAME	CAT. NO.	MODEL NO.	STOCK	C.T. SPEED RANGE*	LIST PRICE	NOM. EFF.	60 HZ F.L. AMPS	WEIGHT	IEC "L" DIM. (MM)	FOOT NOTES
1/4-.18	3600/3000	230/460	200/400	63C	R360	63T34FH5401	✓	20:1	\$211	72.0	0.8/0.4	10	217	
	1800/1500	230/460	200/400	63C	R361	63T17FH5402	✓	20:1	\$219	68.0	1.0/0.5	11	217	
	1200/1000	230/460	200/400	71C	R362	71T11FH5403	✓	20:1	\$382	64.0	1.2/0.6	12	240	
1/3-.25	3600/3000	230/460	200/400	63C	R363	63T34FH5404	✓	20:1	\$247	72.0	1.1/1.55	11	217	
	1800/1500	230/460	200/400	71C	R364	71T17FH5405	✓	20:1	\$250	68.0	1.4/1.7	13	240	
	1200/1000	230/460	200/400	80C	R365	80T11FH5406	✓	20:1	\$410	70.0	1.3/1.65	17	282	
1/2-.37	3600/3000	230/460	200/400	71C	R366	71T34FH5407	✓	20:1	\$251	74.0	1.6/1.8	13	240	
	1800/1500	230/460	200/400	71C	R367	71T17FH5408	✓	20:1	\$261	74.0	1.8/1.9	14	282	
	1200/1000	230/460	200/400	80C	R368	80T11FH5409	✓	20:1	\$427	72.0	1.9/1.95	19	282	
3/4-.55	3600/3000	230/460	200/400	71C	R369	71T34FH5410	✓	20:1	\$264	74.0	2.4/1.2	15	282	
	1800/1500	230/460	200/400	80C	R370	80T17FH5411	✓	20:1	\$283	74.0	2.5/1.25	18	282	
	1200/1000	230/460	200/400	80C	R371	80T11FH5412	✓	20:1	\$452	72.0	2.7/1.35	22	320	
1-.75	3600/3000	230/460	200/400	80C	R372	80T34FH5413	✓	20:1	\$291	75.5	2.8/1.4	21	282	
	1800/1500	230/460	200/400	80C	R373	80T17FH5414	✓	20:1	\$304	80.0	3.2/1.6	26	282	
	1200/1000	230/460	200/400	90SC	R374A	90ST11FH6415	✓	20:1	\$556	82.5	3.3/1.7	35	320	
1 1/2-1.1	3600/3000	230/460	200/400	80C	R375	80T34FH5416	✓	20:1	\$331	84.0	4.0/2.0	30	282	
	1800/1500	230/460	200/400	90SC	R376A	90ST17FH6417	✓	20:1	\$395	86.5	4.6/2.3	37	320	
2-1.5	3600/3000	230/460	200/400	90SC	R377A	90ST34FH6418	✓	20:1	\$430	85.5	5.2/2.6	33	320	
	1800/1500	230/460	200/400	90LC	R378A	90LT17FH6419	✓	20:1	\$439	86.5	5.8/2.9	38	320	
3-2.2	3600/3000	230/460	200/400	90LC	R379A	90LT34FH6420	✓	20:1	\$621	86.5	7.2/3.6	39	320	

Catalog numbers (Cat No.) highlighted in bold blue have efficiency levels that meet EISA requirements

* Requires nameplate modification

Brake Motors, Single Phase

Totally Enclosed, C-Face Footed (Removable Base)

Features:

- Fail-safe, spring set Stearns 56 Series brake for holding or stopping
- Brake has manual wear adjustment for longer pad life
- Manual release lever on rear of brake housing
- Brake leads are terminated at the brake
- Universal mounting, no modifications needed
- Brake coil voltage matches motor voltages, see mod section for other brake coils
- Ball bearings, mechanically locked on shaft end
- 1.15 Service Factor (1.0 Service Factor as noted)
- Nameplated 60/50 hertz at next lowest horsepower
- UL Recognized and CSA Certified



BRAKE MOTORS

HP	RPM	VOLTS	FRAME	CAT. NO.	MODEL NO.	STOCK	LIST PRICE	MULT. SYMB.	F.L. AMPS	WEIGHT	"C" DIM.	BRAKE RATING (Lb/Ft)	FOOT NOTES
1/3	1800	115/208-230	56C	D400	056C17F5352	✓	\$641	E5	6.6/3.1-3.3	33	16.20	3	2,6
1/2	1800	115/208-230	56C	D401	056C17F5353	✓	\$707	E5	8.8/4.2-4.4	34	16.20	3	2,6
3/4	1800	115/208-230	56C	D402	056C17F5354	✓	\$916	E5	11.0/5.4-5.5	38	16.70	6	2,6
1	1800	115/208-230	56C	D403	056C17F5355	✓	\$974	E5	13.4/6.8-6.7	40	17.20	6	2,6
1 1/2	1800	115/208-230	56C	D404	056B17F5330	✓	\$1,028	E5	15.2/8.2-7.6	50	19.04	10	1,6

Brake Motors, Three Phase

Totally Enclosed

Features:

- In addition to the Single Phase Features above:
- Brake has manual wear adjustment for longer pad life
- Brake leads routed through motor conduit box (TENV only)
- Universal mounting, no modifications needed
- CR200 Corona resistant magnet wire (motor can be operated 10:1 variable torque)



Rigid Base

Suitable for use on VFD per guidelines on page 17.

HP	RPM	VOLTS	FRAME	CAT. NO.	MODEL NO.	STOCK	LIST PRICE	MULT. SYMB.	F.L. AMPS	WEIGHT	"C" DIM.	BRAKE RATING (Lb/Ft)	FOOT NOTES
1/2	1800	230/460	56	K456	5K49KN4573	✓	\$820	E5	1.8/0.9	31	14.06	3	17,N
	1200	230/460	56	K526	5K49MN6369	✓	\$1,131	E5	2.4/1.2	33	15.56	3	17,N
3/4	1800	230/460	56	K458	5K49PN4564	✓	\$1,014	E5	2.5/1.25	36	14.56	6	17,N
1	1800	230/460	56	K459	5K49UN4569	✓	\$1,173	E5	3.2/1.6	45	15.56	6	17,N
	1800	230/460	143T	K461	5K49UN4566	✓	\$1,173	E5	3.2/1.6	47	16.00	6	17,N
2	1800	230/460	145T	K2045	5KE49WN4571	✓	\$1,213	E5	5.6/2.8	44	18.00	10	17



C-Face Footless

HP	RPM	VOLTS	FRAME	CAT. NO.	MODEL NO.	STOCK	LIST PRICE	MULT. SYMB.	F.L. AMPS	WEIGHT	"C" DIM.	BRAKE RATING (Lb/Ft)	FOOT NOTES
1/2	1800	230/460	56C	K457	5K49KN4563	✓	\$678	E5	1.8/0.9	31	14.06	3	N,17
3/4	1800	230/460	56C	K460	5K49PN4565	✓	\$797	E5	2.5/1.25	37	14.56	6	N,17
1	1800	230/460	143TC	K462	5K49UN4567	✓	\$1,192	E5	3.2/1.6	46	16.00	6	N,17
1 1/2	1800	208-230/460	56C	K1494	5K49RN4570	✓	\$1,050	E5	5.0/2.5	40	16.56	10	17
2	1800	230/460	145TC	K2046	5KE49WN4572	✓	\$1,103	E5	5.6/2.8	44	18.00	10	17

Brake Motors, Three Phase

C-Face Footed, C-Face Footed (Removable Base)

Features:

- In addition to the Single Phase Features on previous page:
- Brake has manual wear adjustment up to 25 lb-ft. for longer pad life
- Stearns brakes, 56 series through 25 Lb-Ft, 87 series above 35 Lb-Ft and larger
- Brake leads routed through motor conduit box (TENV only)
- Universal mounting up to 15 Lb-Ft, C406 has verticle springs included, for larger brakes, see mod section
- CR²⁰⁰ Corona resistant magnet wire (motor can be operated 10:1 variable torque and 2:1 constant torque)
- 1.15 Service Factor, 1.0 Service Factor where footnoted



Suitable for use on VFD per guidelines on page 17.

HP	RPM	VOLTS	FRAME	CAT. NO.	MODEL NO.	STOCK	LIST PRICE	MULT. SYMB.	F.L. AMPS	WEIGHT	"C" DIM.	BRAKE RATING (Lb/Ft)	FOOT NOTES
1/3	1800	208-230/460	56C	D450	056T17F5348	✓	\$603	E5	1.8-1.6/0.8	30	15.73	3	6
	1200	208-230/460	56C	D451	056T11F5325	✓	\$799	E5	1.9-2.2/1.1	30	15.73	3	6
1/2	1800	208-230/460	56C	D452	056T17F5349	✓	\$678	E5	2.3-2.4/1.2	32	16.23	3	6
	1200	208-230/460	56C	D453	056T11F5326	✓	\$997	E5	2.4-2.7/1.4	33	16.23	6	6
3/4	1800	208-230/460	56C	D454	056T17F5350	✓	\$797	E5	2.9-3.0/1.5	33	16.23	6	6
	1200	208-230/460	56C	D455	056T11F5327	✓	\$1,171	E5	3.1-3.2/1.6	37	16.73	6	6
1	1800	208-230/460	56C	D456	056T17F5357	✓	\$946	E5	3.5-3.6/1.8	35	16.73	6	6
	1200	208-230/460	145TC	C400	145TFR5382	✓	\$1,255	E5	3.95-4.0/2.0	48	17.26	10	6
1 1/2	1800	208-230/460	56HC	D457	056T17F5358	✓	\$1,050	E5	4.8-4.8/2.4	38	17.26	10	6
	1800	208-230/460	145TC	C401	145TFR5360	✓	\$1,050	E5	4.8-4.8/2.4	40	16.76	10	6
	1200	208-230/460	184TC	C402	184TTTL7084	✓	\$1,399	E5	5.55-5.2/2.6	130	19.23	15	AL,F,N,82
2	1800	208-230/460	145TC	C403	145TFR5359	✓	\$1,103	E5	6.0-5.8/2.9	49	18.77	10	6
	1200	208-230/460	184TC	C404	184TTTL7083	✓	\$1,460	E5	6.8-6.6/3.3	90	19.23	15	AL,F,N,82
3	1800	230/460	182TC	C405	182TTTL7034	✓	\$1,460	E5	8.0/4.0	100	19.68	15	AL,F,N,82
5	1800	208-230/460	184TC	C406	184TTTL7041	✓	\$1,974	E5	13.8-12.4/6.2	115	20.68	25	AL,F,N,17,82
7 1/2	1800	230/460	213TC	C407	213TTTL7034	✓	\$2,592	E5	19.2/9.6	176	27.04	35	AL,N,17,82
10	1800	230/460	215TC	C408	215TTTL7050	✓	\$3,240	E5	25.0/12.5	211	28.64	50	AL,N,17,82

Farm Duty / Agriculture, High Torque

Single Phase, TEFC

Features:

- Ball bearings, shaft end mechanically locked on C-face models (excludes 5K models)
- 1.15 Service Factor (except as noted)
- Capacitor start design for high starting torque
- Capacitor start/capacitor run design for higher efficiency, as noted
- Low temperature manual reset thermal protector
- Totally enclosed and fully gasketed construction for dirty environments
- Condensate drains
- Shaft slinger
- UL Recognized and CSA Certified



Rigid Base

HP	RPM	VOLTS	FRAME	CAT. NO.	MODEL NO.	STOCK	LIST PRICE	MULT. SYMB.	F.L. AMPS	WEIGHT	"C" DIM.	FOOT NOTES
1/3	1800	115/208-230	56	F101	056C17F5324	✓	\$286	F1	6.6/3.1-3.3	24	11.82	
1/2	1800	115/208-230	56	F102	056C17F5325	✓	\$327	F1	8.8/4.2-4.4	25	11.82	
3/4	1800	115/208-230	56	F103	056C17F5326	✓	\$390	F1	11.0/5.4-5.5	29	12.32	
1	1800	115/208-230	143T	Z123	143TCFR5328	✓	\$452	S1	13.4/6.8-6.7	31	12.87	
	1800	115/230	56	F10E1	5KC49TN0063Y	✓	\$425	F1	13.2/6.6	37	12.96	d,17
	1800	115/208-230	56	F104	056C17F5327	✓	\$425	F1	13.4/6.8-6.7	31	12.82	
1 1/2	1800	115/208-230	145T	F15E1	5KCR48WN0292Y		\$532	S1	14.5/7.1-7.3	44	14.07	ES,1
	1800	115/208-230	145T	Z118	145TBFR5328	✓	\$532	S1	15.2/8.2-7.6	40	13.87	1
	1800	115/208-230	56H	F105	056B17F5307	✓	\$522	F1	15.2/8.2-7.6	41	13.82	ES,1
2	1800	115/230	145T	Z128	145TBFR5341	✓	\$591	S1	18.8/9.4	49	14.87	1
	1800	115/230	182T	Z119A	182TCFW7072	✓	\$644	S1	24.0/12.0	66	14.46	13
3	1800	230	184T	Z120A	184TBFW17045	✓	\$802	S1	14.2	92	14.96	1,13
5	1800	230	184T	Z121A	184TBFW7737	✓	\$976	S1	19.5	103	17.45	1,13
7 1/2	1800	230	215T	Z122	215TBFW7029	✓	\$1,448	S1	30.0	138	21.48	1

FARM DUTY / AGRICULTURAL

C-Face Footed (Rigid Base)

HP	RPM	VOLTS	FRAME	CAT. NO.	MODEL NO.	STOCK	LIST PRICE	MULT. SYMB.	F.L. AMPS	WEIGHT	"C" DIM.	FOOT NOTES
1/3	1800	115/208-230	56C	F131	056C17F5358	✓	\$349	F1	6.6/3.1-3.3	23	11.82	
1/2	1800	115/208-230	56C	F132	056C17F5912	✓	\$390	F1	8.8/4.2-4.4	25	11.82	
3/4	1800	115/208-230	56C	F133	056C17F5913	✓	\$454	F1	11/5.4-5.5	29	12.32	
1	1800	115/208-230	56C	F134	056C17F5914	✓	\$488	F1	13.4/6.8-6.7	31	12.82	
1 1/2	1800	115/208-230	56HC	F135	056B17F5584	✓	\$586	F1	15.2/8.2-7.6	41	13.82	1,5
2	1800	115/230	56HC	K319	056B17F5319	✓	\$601	F1	18.8/9.4	50	14.82	1,5
3	1800	230	184TC	I314A	184TBFW7041	✓	\$901	S1	12.8	86	14.96	1,13
5	1800	230	184TC	I315A	184TBFW7034	✓	\$1,075	S1	19.5	101	17.47	1,13

Farm Duty / Agriculture, Extra-High Torque Chore Motor®

Single Phase, TEFC, Rigid Base

Features:

- Class F insulation
- 1.15 Service Factor (except as noted)
- Ball bearings
- 300% and greater starting torque for hard-to-start applications
- Totally enclosed and fully gasketed for dirty environments
- 213/215TZ models have 1-1/8" shaft, 182TZ model has 7/8" shaft
- Manual reset thermal protector
- Condensate drains
- Shaft slinger
- UL Recognized and CSA Certified



HP	RPM	VOLTS	FRAME	CAT. NO.	MODEL NO.	STOCK	LIST PRICE	MULT. SYMB.	F.L. AMPS	WEIGHT	"C" DIM.	FOOT NOTES
2	1800	115/230	182TZ	Z112A	182TCFW9061	✓	\$682	S1	24.0/12.0	68	14.46	2,13
3	1800	230	184T	Z113A	184TCFW9057	✓	\$848	S1	19.0	90	16.46	2,13
5	1800	208-230	184T	Z114A	184TBFW7070	✓	\$1,034	S1	23.8/21.8	98	14.46	1,13
	1800	230	213TZ	Z117	213TBFW7027	✓	\$1,150	S1	23.0	119	18.73	1
7 1/2	1800	230	215TZ	Z115	215TBFW7028	✓	\$1,535	S1	32.0	155	21.48	1
10	1800	230	215T	Z116	215TBFW7044	✓	\$1,911	S1	40.0	133	21.48	1,17

Farm Duty / Agriculture, Auger Drive

Single Phase, TEFC, N Flange

Features:

- NEMA N flange mounting
- Manual reset thermal protector
- 48NZ: 1/2" dia. X 1.5" long shaft with flat
- 56NZ: 5/8" dia. X 2.06" long shaft with flat
- Extended (ODE) Shaft with flats for manual jogging
- F1201, F1202, F1203, F1204, and F1205 utilize a solid state electronic starting switch
- Ball bearings
- UL Recognized and CSA Certified



HP	RPM	VOLTS	FRAME	CAT. NO.	MODEL NO.	STOCK	LIST PRICE	MULT. SYMB.	F.L. AMPS	WEIGHT	"C" DIM.	FOOT NOTES
1/3	1800	115/230	48NY	HG646	5KH39QN9508Y	✓	\$307	F1	5.3/2.7	22	11.07	N,3,83
	1800	115/208-230	56NY	C1291	5KC46GN0075U	✓	\$256	F1	5.8/2.8-2.9	21	12.00	
	1800	115/230	48NZ	F1201	048C17F11005	✓	\$340	F1	6.2/3.1	22	10.31	E,2
1/2	1800/1500	115/208-230	56NY	C1292	5KC46JN0076U	✓	\$338	F1	8.4/4.0-4.2	23	12.00	2,49,50
	1800	115/208-230	48NZ	F1202	048C17F11006	✓	\$370	F1	8.0/3.8-4.0	22	10.56	E,2
3/4	1800	115/208-230	56NY	C1293	5KCR49PN0077U	✓	\$399	F1	8.4/4.5-4.2	31	13.13	ES,1
	1800	115/208-230	48NZ	F1203	048C17F11007	✓	\$431	F1	10.8/5.3-5.4	20	11.31	E,2
1	1800/1500	115/208-230	56NY	C1294	5KCR49UN0079U	✓	\$447	F1	10.8/6.0-5.4	40	14.51	ES,1,50,83
	1800	115/230	56NZ	F1204	056C17F15537	✓	\$479	F1	13.4/6.7	36	13.38	E,2
1 1/2	1800	115/208-230	56NY	C1295	5KCR49WN0295U	✓	\$539	F1	14.5/7.1-7.3	44	14.51	ES,1,83
	1800	115/230	56NZ	F1205	056B17F15516	✓	\$576	F1	15.2/7.6	45	14.38	E,1

Grain Stirring, Single Phase

TEFC, Rigid Base

Applications:

Definite purpose for grain stirring systems inside grain bins.

Features:

- 1.15 Service Factor
- Fully gasketed construction to keep grain dust out
- 7/8" diameter shaft
- Fan/Fan guard on shaft end keeps grain dust out of motor
- Durable powder coat paint
- Manual reset thermal protector
- Ball bearings
- UL Recognized and CSA Certified

HP	RPM	VOLTS	FRAME	CAT. NO.	MODEL NO.	STOCK	LIST PRICE	MULT. SYMB.	F.L. AMPS	WEIGHT	"C" DIM.	FOOT NOTES
1 1/2	1800	115/208-230	56HZ	X902	056B17F5324		\$457	F1	15.2/8.2-7.6	46	13.21	1,5

Farm Duty, Capacitor Start

TEAO, Rigid Base - High Efficiency

Applications:

Designed for demanding agricultural belt drive fan applications such as poultry house fans and barn exhaust fans. **Catalog X912 is Totally Enclosed Air Over and must be mounted within the airstream for proper cooling.**

Features:

- Capacitor start/capacitor run design
- Automatic reset thermal protector for higher efficiency
- Suitable for belted loads
- Fully gasketed
- Ball bearings
- UL Recognized and CSA Certified
- Continuous duty



FARM DUTY / AGRICULTURAL

HP	RPM	VOLTS	FRAME	CAT. NO.	MODEL NO.	STOCK	LIST PRICE	MULT. SYMB.	F.L. AMPS	WEIGHT	"C" DIM.	FOOT NOTES
1/2	1800	115/230	56	X913	056B17T20	✓	\$305	F1	4.6/2.3	22	10.47	1
	900	208-230	56Y	F781	5KCP49UN9838S	✓	\$312	F1	3.7-3.6	40	11.91	93
1	1800	115/230	56	X912	056B17T5303	✓	\$399	F1	9.2/4.6	32	11.44	1

Farm Duty, PSC

TEAO, Resilient Base - Thru Bolt - Variable Speed

Applications:

Designed for demanding agricultural fan applications such as poultry houses and barn exhaust fans. Must be mounted within the airstream for proper cooling. Variable speed capabilities when used with a single phase speed control unit – NOT supplied by Marathon Motors. Super Variable speed motors, catalog X030, X031, and X032, are designed for lower temperature rise throughout a greater speed range.

Features:

- Ball bearings
- Extended thru-bolts
- Fully gasketed
- 48/56 Frame mounting holes
- Continuous duty
- Automatic reset thermal protector
- 1/2" dia. x 2-1/2" long shaft with two flats, 90° apart
- UL Recognized and CSA Certified



HP	RPM	VOLTS	FRAME	CAT. NO.	MODEL NO.	STOCK	LIST PRICE	MULT. SYMB.	F.L. AMPS	WEIGHT	"C" DIM.	FOOT NOTES
1/4	1625	115/230	48YZ	X030	048A17T118	✓	\$218	F1	3.6/1.8	20	11.06	
	1625	115/230	48YZ	X024	048A17T2002	✓	\$178	F1	3.2/1.6	18	10.09	
	1075	115/230	48YZ	X027	048A11T2021	✓	\$194	F1	3.2/1.6	15	10.09	
1/3	1625	115/230	48YZ	X031	048A17T237	✓	\$241	F1	3.8/1.9	23	11.81	
	1625	115/230	48YZ	X025	048A17T2003	✓	\$198	F1	4.4/2.2	18	10.09	
	1075	115/230	48YZ	X028	048A11T2022	✓	\$210	F1	4.2/2.1	21	10.84	
1/2	1625	115/230	48YZ	X032	048A17T119	✓	\$266	F1	5.4/2.7	24	11.81	
	1625	115/230	48YZ	X026	048A17T2004	✓	\$215	F1	6.0/3.0	22	10.84	
	1075	115/230	48YZ	X029	048A11T2023	✓	\$225	F1	6.4/3.2	22	10.84	

Farm Duty / Agricultural

Single Phase, TEAO, Resilient Base-Thru Bolt

Features:

- Split Phase and PSC, as noted
- Ball bearings
- Extended thru-bolts on X1903, X1904, P250, and P251
- 48Z Frame has 1/2" dia. x 2-1/2" long shaft with two flats
- 56Z Frame has 1/2" dia. x 1-7/8" long with 1-5/8" flat
- 48Y & 48YZ have 48/56 Fr. Mounting holes
- 1.0 Service Factor (except as noted)
- Thermal protection, as noted
- Fully Gasketed



FARM DUTY / AGRICULTURAL

HP	RPM	VOLTS	FRAME	OVER LOAD	CAT. NO.	MODEL NO.	STOCK	LIST PRICE	MULT. SYMB.	F.L. AMPS	WEIGHT	"C" DIM.	FOOT NOTES	
1/6	1800	115	48	AUTO	HG196	5KH32GN42S	✓	\$203	F1	3.5	13	8.94	3	
	1800	115	48	NONE	H195	5KH32GN42	✓	\$198	F1	3.5	13	8.94	3	
	1200	115	48	AUTO	H198	5KH35MN132S	✓	\$304	F1	3.7	17	9.57	3	
	1200	115	48	NONE	H197	5KH35MN132	✓	\$293	F1	3.7	17	9.57	3	
1/4	1800	115	48Z	AUTO	X1903	5KH32FNA499S	✓	\$158	F1	5.1	14	9.68	3,9	
	1800	115/208-230	48	AUTO	H649	5KHC39QN9575T	✓	\$329	F1	3.0/1.6-1.5	16	10.40	3	
	1800	115	48	AUTO	H135	5KH32FN3122S	✓	\$215	F1	5.1	15	8.94	3	
	1800	115/230	48Z	AUTO	P250	5KCP35KNB057S	✓	\$209	F1	3.6/1.8	16	10.57	93	
	1800	115	48	NONE	H134	5KH32FN3122	✓	\$204	F1	5.1	15	8.94	3	
	1800	230	48	AUTO	H277	5KH33KN20S	✓	\$240	F1	2.3	15	9.19	3	
	1800/1200	115	48	NONE	H203	5KH36PN106	✓	\$250	F1	4.2/2.7	20	10.00	3	
	1200	115	56	AUTO	H137	5KH49MN6057S	✓	\$358	F1	5.6	22	10.48	3	
	1200	115	56	NONE	H136	5KH49MN6057	✓	\$348	F1	5.6	23	10.48	3	
	1/3	1800	115	48Z	AUTO	X1904	5KH33JNA500S	✓	\$178	F1	6.2	15	9.93	3,9
1800		115	48	AUTO	H139	5KH33JN3121S	✓	\$255	F1	6.2	18	9.19	3	
1800		115	48	NONE	HG138	5KH33JN3121	✓	\$244	F1	6.2	18	9.19	3	
1800		115/208-230	48	AUTO	HG648	5KHC39QN9581T	✓	\$356	F1	4.1/2.1-2.0	17	10.40	3	
1800		230	48	NONE	HG140	5KH36NN37	✓	\$256	F1	2.5	18	10.00	3	
1800		230	48	AUTO	HG141	5KH36NN37S	✓	\$261	F1	2.5	18	10.00	3	
1200		115/230	56	AUTO	HG699	5KH49PN6056S	✓	\$416	F1	7.0/3.5	26	11.48	3	
1200		115/230	56	NONE	HG142	5KH49PN6056	✓	\$404	F1	7.0/3.5	27	11.48	3	
1/2		1800	115/208-230	56	AUTO	H247	5KH42JN0328S	✓	\$242	F1	8.0/4.0-4.0	21	10.05	3
		1200	115/230	48Z	AUTO	P251	5KCP36NNB059S	✓	\$269	F1	7.2/3.6	18	11.0	93
	1800	115/208-230	56	NONE	H276	5KH42JN0328	✓	\$342	F1	8.0/4.0-4.0	21	10.05	3	
	1800	115/208-230	56	AUTO	H647	5KHC39QN9584X	✓	\$377	F1	5.2/2.7-2.6	19	10.05	3	
	1800	115	56	NONE	HG143	5KH42GN0337	✓	\$325	F1	8.0	21	10.05	3,19	
3/4	1800	115/208-230	56	AUTO	C1314	5KCR49PN0492S	✓	\$313	F1	7.0/3.8-3.5	30	11.38	1,50,55,111	
	1800	115/208-230	56	AUTO	C1303	5KCR46NN0264T	✓	\$400	F1	8.2/4.0-4.1	28	10.78	1,19	
1	1800	115/208-230	56	AUTO	C1315	5KCR49SN0493S	✓	\$367	F1	10.6/5.5-5.3	34	11.85	1,111	
	1800	115/208-230	56	AUTO	C1302	5KCR49SN0042S	✓	\$419	F1	9.6/5.2-4.8	35	11.91	1,50,55,111	
1 1/2	1800	115/208-230	56	AUTO	C1909	5KCR49ZN0785S	✓	\$431	F1	14.0/7.2-7.0	49	13.96	1,50,55,111	

Crop Dryer, Single Phase

Dripproof/Air Over, Rigid Base

Applications:

Crop dryers with air over/fan on shaft designs.

Features:

- Double sealed ball bearings
- Continuous duty
- Class F insulation system
- Thermostats for thermal overload protection (auto reset protector on Z304)
- 34" long leads for ease of installation
- Keyed shafts with 1/4"-20 UNC tapped hole in end
- Capacitors included, shipped loose on catalog Z307 and Z308, mounted on all other models
- Extra nameplate included, loose, for remote mounting



HP	RPM	VOLTS	FRAME	OVER LOAD	CAT. NO.	MODEL NO.	STOCK	LIST PRICE	MULT. SYMB.	F.L. AMPS	WEIGHT	"C" DIM.	FOOT NOTES
3-4.5	3600	230	145TZ	AUTO	Z304	145TBDR5309	√	\$611	S1	13.0-19.0	43	13.74	1
3-5	3600	230	182TZ	TSTAT	Z309	182TCDR7013		\$734	S1	15.8-25.3	67	15.00	2
5-7.5	3600	230	184TZ	TSTAT	Z305A	184TCDW7615	√	\$894	S1	27.2-35.0	98	15.88	2,13
7-10	3600	230	184TZ	TSTAT	Z307A	184TBDW7009	√	\$1,126	S1	31.0-42.0	95	15.88	1,13
7.5-10	3600	230	184TZ	TSTAT	Z313	184TBDR7324		\$1,126	S1	30.0-42.0	89	16.43	1,13
7.5-10.5	3600	230	215TZ	TSTAT	Z314	215TCDW7012		\$1,316	S1	37.0-49.5	139	19.16	2,F
7-9	3600	230	184TZ	TSTAT	Z306A	184TCDW7617	√	\$1,009	S1	36.5-46.0	83	14.88	2,13
10-15	3600	230	215TZ	TSTAT	Z315	215TBDW7013		\$1,515	S1	39.5-61.5	159	20.42	1,F
	3600	230	215TZ	TSTAT	Z308	215TCDW7003	√	\$1,515	S1	46.0-71.0	135	18.16	2

Crop Dryer, Three Phase

Open/Air Over, Rigid Base

Applications:

Crop dryers with air over/fan on shaft designs where three phase power is available.

Features:

- Ball bearings
- Thermostats for thermal overload protection
- 34" long leads exit elbow connector in bracket
- Keyed shafts with 1/4"-20 UNC tapped hole in end
- Extra nameplate included, loose, for remote mounting
- Continuous duty
- Class F insulation



HP	RPM	VOLTS	FRAME	CAT. NO.	MODEL NO.	STOCK	LIST PRICE	MULT. SYMB.	F.L. AMPS @ LOW SPEED	WEIGHT	"C" DIM.	FOOT NOTES
5-7	3600	208-220/440	184TZ	Y302A	184TTDW7611	√	\$749	E6	13.8-13.2/6.6	71	13.16	13
7-10	3600	208-220/440	184TZ	Y1303	184TTDW7612	√	\$794	E6	20.0-19.2/9.6	69	16.19	13
10-15	3600	208-220/440	215TZ	Y304	215TTDW7301	√	\$1,048	E6	28-26.1/13.1	95	17.41	2,13

Farm Duty / Agricultural

Single Phase, TEAO, Direct Drive-Thru Bolt

Features:

- Economical split phase design
- X909 has 1/2" diameter x 1.5" long shaft with flat
- X910 and X911 have 1/2" dia. X 2-1/2" long shaft with two flats, 90 degrees apart
- Thermal protection, as noted
- Ball bearings
- Fully gasketed



Single Speed

HP	RPM	VOLTS	FRAME	OVER LOAD	CAT. NO.	MODEL NO.	STOCK	LIST PRICE	MULT. SYMB.	F.L. AMPS	WEIGHT	"C" DIM.	FOOT NOTES
1/4	1800	115	48Y	MANUAL	X909	048S17T2004	✓	\$156	F1	4.0	10	7.62	3,59
1/2	900	208-230	56Y	AUTO	F780	5KCP49UN9837S	✓	\$305	F1	3.7-3.6	40	11.91	93

Two Speed

HP	RPM	VOLTS	FRAME	OVER LOAD	CAT. NO.	MODEL NO.	STOCK	LIST PRICE	MULT. SYMB.	F.L. AMPS	WEIGHT	"C" DIM.	FOOT NOTES
1/4	1800/1200	115	48YZ	AUTO	X910	048S17T366	✓	\$202	F1	4.1/2.5	17	11.09	3,59
1/3	1800/1200	115	48YZ	AUTO	X911	048S17T365	✓	\$254	F1	5.3/2.9	18	11.34	3,59



Incubator/Hatchery Vent Fan

Single Phase (PSC), TEAO, Thru-Bolt

HP	RPM	VOLTS	FRAME	CAT. NO.	MODEL NO.	STOCK	LIST PRICE	MULT. SYMB.	F.L. AMPS	WEIGHT	"C" DIM.	FOOT NOTES
1/3	1800	115/230	48Z	P239	5KCP33GNA471S	✓	\$352	F1	4.0/2.0	15	10.18	d



Center Pivot Irrigation

Three Phase, TEFC, C-Face footless

HP	RPM	VOLTS	FRAME	CAT. NO.	MODEL NO.	STOCK	LIST PRICE	MULT. SYMB.	F.L. AMPS	WEIGHT	"C" DIM.	FOOT NOTES
1	1800/1500	460/380	56C	K1476	5K49JN4051T	✓	\$386	F1	2.0/2.1	23	12.08	50
1 1/2	1800/1500	460/380	56C	K1438	5K49NN4052T	✓	\$436	F1	2.4/2.7	29	12.08	50

PowerWash™ XT Washdown Duty, Single Phase

White Epoxy, Totally Enclosed

Features:

- Encapsulated electronic starting switch is impervious to moisture
- Capacitor start induction run design for high starting torque unless otherwise noted
- Class F insulation
- 1.15 Service Factor
- Double sealed ball bearings
- 303 Stainless steel shaft with spring loaded contact seals in each endshield
- Stainless steel conduit box cover, nameplate, fan guard (TEFC) and hardware
- Cast oversized conduit box with high temperature Nitrile gaskets and threaded entrance
- Plugged drain holes in each endshield for all angle mounting
- Internal corrosion resistant coatings on frame, base, endshields, rotor and stator
- USDA-approved, white epoxy RUST-OLEUM® paint
- UL Recognized, CSA Certified and CE Mark



IP55

Rigid Base

HP	RPM	VOLTS	FRAME	CAT. NO.	MODEL NO.	STOCK	LIST PRICE	MULT. SYMB.	F.L. AMPS	WEIGHT	"C" DIM.	FOOT NOTES
1/2	1800	115/208-230	56	N680	056C17W5336	✓	\$512	F3	8.8/4.4-4.4	30	10.81	
3/4	1800	115/208-230	56	N681	056C17W5337	✓	\$601	F3	10.8/5.4-5.4	25	11.31	
1	1800	115/208-230	56	N682	056C17W5338	✓	\$688	F3	12.8/6.4-6.4	34	11.81	
	1800	115/208-230	143T	N685	143TCWR17031	✓	\$648	F3	12.8/6.4-6.4	78	12.43	
1 1/2	1800	115/208-230	145T	N683	145TCWR5326	✓	\$876	F3	19.0/9.5-9.5	50	13.75	
	2	1800	115/208-230	182T	N684A	182TCWW7026	✓	\$1,273	F3	25.2/12.6-2.6	65	13.46

C-Face Footless

HP	RPM	VOLTS	FRAME	CAT. NO.	MODEL NO.	STOCK	LIST PRICE	MULT. SYMB.	F.L. AMPS	WEIGHT	"C" DIM.	FOOT NOTES
1/3	3600	115/208-230	56C	N530	056C34W5301	✓	\$420	F3	5.2/2.8-2.6	28	10.69	
	1800	115/208-230	56C	N531	056C17W5326	✓	\$456	F3	6.4/3.2-3.2	23	10.69	
1/2	3600	115/208-230	56C	N532	056C34W5302	✓	\$456	F3	7.6/4.0-3.8	27	10.69	
	1800	115/208-230	56C	N523	056C17W5327	✓	\$468	F3	8.8/4.4-4.4	26	11.19	
3/4	3600	115/208-230	56C	N524	056C34W5303	✓	\$459	F3	10.0/5.2-5.0	30	11.69	
	1800	115/208-230	56C	N525	056C17W5328	✓	\$541	F3	10.8/5.4-5.4	31	11.69	
1	3600	115/208-230	56C	N526	056C34W5304	✓	\$461	F3	12.0/6.2-6.0	32	12.19	
	1800	115/208-230	56C	N527	056C17W5329	✓	\$613	F3	12.8/6.4-6.4	33	12.19	
1 1/2	3600	115/208-230	56C	N528	056C34W5305	✓	\$680	F3	17.0/8.5-8.5	50	12.69	
	1800	115/208-230	56C	N529	056C17W5330	✓	\$785	F3	19.0/9.5-9.5	23	13.69	

C-Face Footed (Rigid Base)

HP	RPM	VOLTS	FRAME	CAT. NO.	MODEL NO.	STOCK	LIST PRICE	MULT. SYMB.	F.L. AMPS	WEIGHT	"C" DIM.	FOOT NOTES
1/3	3600	115/208-230	56C	N556	056C34W5306	✓	\$423	F3	5.2/2.7-2.6	50	10.41	
	1800	115/208-230	56C	N557	056C17W5331	✓	\$459	F3	6.4/3.2-3.2	25	10.69	
1/2	3600	115/208-230	56C	N558	056C34W5307	✓	\$459	F3	7.6/4.0-3.8	26	10.69	
	1800	115/208-230	56C	N559	056C17W5332	✓	\$474	F3	8.8/4.4-4.4	27	11.19	
3/4	3600	115/208-230	56C	N540	056C34W5308	✓	\$463	F3	10.0/5.2-5.0	31	11.69	
	1800	115/208-230	56C	N541	056C17W5333	✓	\$538	F3	10.8/5.4-5.4	31	11.69	
1	3600	115/208-230	56C	N542	056C34W5309	✓	\$465	F3	12.0/6.2-6.0	33	12.19	
	1800	115/208-230	56C	N543	056C17W5334	✓	\$618	F3	12.8/6.4-6.4	34	12.19	
1 1/2	3600	115/208-230	56C	N544	056C34W5310	✓	\$682	F3	17.0/8.5-8.5	36	12.69	
	1800	115/208-230	56HC	N545	056C17W5335	✓	\$789	F3	19.0/9.5-9.5	43	13.69	5
2	3600	115/208-230	56HC	N546	056C34W99003	✓	\$823	F3	20.0/11.4-10.0	55	12.87	5

WASHDOWN - Painted and Stainless Steel

PowerWash™ XT Washdown Duty, Three Phase

White Epoxy, Totally Enclosed

Features:

- 10:1 Variable torque, Constant torque speed range as listed below
- MAX GUARD® Class F insulation system
- 1.15 Service Factor on sinewave, 1.0 Service Factor on IGBT power
- Double sealed ball bearings
- 303 Stainless steel shaft with spring loaded contact seals in each endshield (Drive end only on TENV motors)
- Stainless steel conduit box cover, nameplate, fan guard (TEFC only) and hardware
- Cast oversized conduit box with high temperature nitrile gaskets and threaded entrance
- Plugged drain holes in each endshield for all angle mounting
- Internal corrosion resistant coatings on frame, base, endshields, rotor and stator
- USDA-approved, white epoxy RUST-OLEUM® paint
- UL Recognized, CSA Certified and CE Mark



IP55



Rigid Base

Suitable for use on VFD per guidelines on page 17.

HP	RPM	VOLTS	FRAME	CAT. NO.	MODEL NO.	STOCK	CT SPEED RANGE*	LIST PRICE	MULT. SYMB.	NOM. EFF.	F.L. AMPS	WEIGHT	"C" DIM.	FOOT NOTES
1/3	1800	208-230/460	56	E286	5KS49HN4595	✓	10:1	\$450	F3	75.5	1.2-1.6/8	24	9.68	ES,N,20,50
1/2	1800	208-230/460	56	N322	056T17W5344	✓	10:1	\$462	F3	74.0	2.0-2.0/1.0	25	10.81	V
3/4	1800	208-230/460	56	N320	056T17W5340	✓	10:1	\$492	F3	77.0	2.8-2.8/1.4	25	10.81	V
1	1800	208-230/460	56	N309	056T17V5346	✓	1000:1	\$517	F3	80.0	3.2-3.2/1.6	35	11.18	N
	1800	208-230/460	143T	N310	143TTWR5329	✓	1000:1	\$564	F3	82.5	3.2-3.2/1.6	35	11.62	N
	1200	208-230/460	145T	N323	145TTWR6076	✓	10:1	\$884	F3	82.5	3.6-4.2/2.1	45	13.25	V
1 1/2	1800	208-230/460	145T	N321A	145TTWR6029	✓	10:1	\$659	F3	86.5	5.2-4.4/2.2	51	12.75	V
2	1800	208-230/460	145T	N312A	145TTWR6027	✓	10:1	\$819	F3	86.5	6.0-5.6/2.8	46	13.75	V
3	3600	208-230/460	145T	N324	145TTWR16002	✓	10:1	\$997	F3	86.5	8.8-8.0/4.0	52	13.68	V
	1800	208-230/460	56HZ	N313	056T17W5328	✓	10:1	\$661	F3	82.5	8.6-8.6/4.3	49	14.25	V,Z,5,17
	1800	208-230/460	182T	N314B	182TTWW6027	✓	10:1	\$1,083	F3	89.5	8.2-8.2/4.1	69	13.96	V,13
5	3600	208-230/460	184T	N315A	184TTWW6004	✓	10:1	\$1,363	F3	88.5	13.2-12.0/6.0	75	14.46	V,13
	1800	208-230/460	184T	N316B	184TTWW6027	✓	10:1	\$1,238	F3	89.5	13.0-13.0/6.5	85	14.96	V,13
7 1/2	3600	208-230/460	184T	N317A	184TTWW6003	✓	10:1	\$1,720	F3	89.5	17.6-16.8/8.4	87	15.96	V,13
	3600	208-230/460	213T	N325	213TTWW16002	✓	10:1	\$1,920	F3	89.5	19.2-17.6/8.8	87	16.59	V,68
	1800	208-230/460	213T	N318A	213TTWR6027	✓	10:1	\$1,545	F3	91.7	20.4-20.4/10.2	131	17.21	V
10	1800	208-230/460	215T	N319A	215TTWR6027	✓	10:1	\$1,849	F3	91.7	26.0-26.0/13.0	165	18.71	V

Catalog numbers (Cat No.) highlighted in bold blue have efficiency levels that meet EISA requirements

* Requires nameplate modification

WASHDOWN - Painted and Stainless Steel

PowerWash™ XT Washdown Duty, Three Phase

White Epoxy, Totally Enclosed



C-Face Footless

Same features as shown on page 106

HP	RPM	VOLTS	FRAME	CAT. NO.	MODEL NO.	STOCK	CT SPEED RANGE*	LIST PRICE	MULT. SYMB.	NOM. EFF.	F.L. AMPS	WEIGHT	"C" DIM.	FOOT NOTES
1/4	1800	208-230/460	56C	N640	056T17V5326	✓	1000:1	\$436	F3	68.0	1.1-1.1/55	21	9.56	N
1/3	3600	208-230/460	56C	N665	056T34V99001	✓	1000:1	\$380	F3	77.0	1.1-1.1/55	19	10.06	N
	1800	208-230/460	56C	N641	056T17V5327	✓	1000:1	\$463	F3	72.0	1.3-1.3/65	21	9.56	N
	1800	208-230/460	56C	N666	056T17W99003	✓	10:1	\$463	F3	68.0	1.7-1.7/85	21	10.69	V
1/2	3600	208-230/460	56C	N667	056T34V99002	✓	1000:1	\$447	F3	82.5	1.7-1.6/80	22	10.06	N
	1800	208-230/460	56C	N642	056T17V5328	✓	1000:1	\$478	F3	78.5	1.8-1.8/9	25	10.06	N
	1800	208-230/460	56C	N668	056T17W99006	✓	10:1	\$478	F3	74.0	2.7-2.8/1.4	25	11.19	V
3/4	3600	208-230/460	56C	N643	056T34V5301	✓	1000:1	\$482	F3	84.0	2.6-2.4/1.2	50	11.06	N
	1800	208-230/460	56C	N644	056T17V5329	✓	1000:1	\$553	F3	80.0	2.5-2.5/1.25	30	10.56	N
	1800	208-230/460	56C	N669	056T17W99002	✓	10:1	\$553	F3	77.0	2.7-2.8/1.4	28	11.69	V
1	3600	208-230/460	56C	N645	056T34V5302	✓	1000:1	\$563	F3	78.5	2.8-2.6/1.3	34	11.56	N
	1800	208-230/460	56C	N646	056T17V5330	✓	1000:1	\$576	F3	80.0	3.2-3.2/1.6	34	11.56	N
	1800	208-230/460	143TC	N647	143TTVR5326	✓	1000:1	\$576	F3	80.0	3.2-3.2/1.6	35	11.75	N
1 1/2	3600	208-230/460	56C	N648	056T34V5303	✓	1000:1	\$597	F3	80.0	4.2-3.8/1.9	42	12.56	N
	1800	208-230/460	56C	K2068	5KE49TN4592	✓	10:1	\$591	F3	84.0	4.4-5.3/2.65	40	13.19	d,50
	1800	208-230/460	56C	N649	056T17V5331	✓	1000:1	\$601	F3	84.0	4.2-4.2/2.1	46	13.06	N
	1800	208-230/460	143TC	N650	143TTVR5327	✓	1000:1	\$601	F3	84.0	4.2-4.2/2.1	47	13.25	N
	1800	208-230/460	145TC	K2055	5KE49TN8378	✓	10:1	\$605	F3	84.0	4.4-5.3/2.65	39	13.25	d,50
	3600	208-230/460	56C	N651	056T34V5304	✓	1000:1	\$683	F3	82.5	5.6-5.0/2.5	48	13.06	N
2	3600	208-230/460	145TC	N652	145TTVR5301	✓	1000:1	\$683	F3	82.5	5.6-5.0/2.5	42	13.25	N
	1800	208-230/460	56C	N653	056T17W5326	✓	10:1	\$700	F3	81.5	6.2-6.2/3.1	38	12.69	V
	1800	208-230/460	56C	K2066	5KE48WN4593	✓	10:1	\$637	F3	84.0	6.0-5.6/2.8	44	13.69	d,50
	1800	208-230/460	145TC	K2056	5KE48WN8364	✓	10:1	\$651	F3	84.0	6.0-5.6/2.8	45	13.75	d,50
	1800	208-230/460	145TC	N654A	145TTWR4326	✓	10:1	\$675	F3	84.0	6.0-5.6/2.8	47	13.75	V
	3600	208-230/460	56C	N662	056T34W99001	✓	10:1	\$1,103	F3	84.0	8.4-7.6/3.8	39	13.19	V
3	3600	208-230/460	145TC	N655	145TTWR5301	✓	10:1	\$839	F3	80.0	8.4-7.6/3.8	36	13.25	d,V
	3600	208-230/460	145TC	N655A	145TTWR4301	✓	10:1	\$897	F3	85.5	8.4-7.6/3.8	48	13.75	V
	1800	208-230/460	182TC	N656B	182TTWW4028	✓	10:1	\$987	F3	87.5	8.4-7.6/3.8	81	14.47	V,13
5	3600	208-230/460	184TC	N657B	184TTWW4002	✓	10:1	\$1,251	F3	87.5	13.2-12.0/6.0	75	14.47	V,13
	1800	208-230/460	184TC	N658B	184TTWW4028	✓	10:1	\$1,118	F3	87.5	13.0-13.0/6.5	95	14.97	V,13
7 1/2	3600	208-230/460	213TC	N659A	213TTWR4001	✓	10:1	\$1,551	F3	88.5	17.6-16.8/8.4	102	17.47	V
	1800	208-230/460	213TC	N660	213TTWR7026	✓	10:1	\$1,328	F3	89.5	24.0-22.0/11.0	125	17.71	V
10	3600	208-230/460	215TC	N663	215TTWW16002	✓	10:1	\$1,998	F3	91.7	23.6/11.8	170	21.83	V
	1800	208-230/460	215TC	N661	215TTWR7026	✓	10:1	\$1,507	F3	89.5	29.0-28.0/14.0	150	18.71	V
15	3600	208-230/460	215TC	N664	215TTWW14008	✓	10:1	\$2,050	F3	90.2	36.0/18.0	140	20.57	V

WASHDOWN - Painted and Stainless Steel

Catalog numbers (Cat No.) highlighted in bold blue have efficiency levels that meet EISA requirements

* Requires nameplate modification

PowerWash™ XT Washdown Duty, Three Phase

White Epoxy, Totally Enclosed



C-Face Footed (Rigid Base)

Same features as shown on page 106

HP	RPM	VOLTS	FRAME	CAT. NO.	MODEL NO.	STOCK	CT SPEED RANGE*	LIST PRICE	MULT. SYMB.	NOM. EFF.	F.L. AMPS	WEIGHT	"C" DIM.	FOOT NOTES	
1/4	1800	208-230/460	56C	N564	056T17V5332	✓	1000:1	\$438	F3	68.0	1.1-1.1/55	24	10.08	N	
	1800	575	56C	N620A	056T17V15501	✓	1000:1	\$438	F3	68.0	0.44	23	10.06	N	
1/3	3600	208-230/460	56C	N631	056T34W99002	✓	10:1	\$372	F3	77.0	1.1-1.1/55	22	10.08	V	
	1800	208-230/460	56C	N628	056T17W5334	✓	10:1	\$481	F3	68.0	1.7-1.7/85	23	10.69	V	
	1800	575	56C	N621	056T17W5335	✓	10:1	\$481	F3	68.0	0.68	20	10.69	V	
1/2	3600	208-230/460	56C	N566	056T34V5305	✓	1000:1	\$437	F3	76.0	1.7-1.6/8	27	10.58	N	
	1800	208-230/460	56C	N567	056T17V5336	✓	1000:1	\$490	F3	78.5	1.8-1.8/9	26	10.06	N	
	1800	208-230/460	56C	N632	056T17W99005	✓	10:1	\$490	F3	74.0	1.9-2.0/1.0	22	11.19	V	
	1800	575	56C	N622	056T17V5337	✓	1000:1	\$490	F3	78.5	0.8	25	10.08	N	
	1200	208-230/460	56C	N568	056T11V5376	✓	1000:1	\$611	F3	77.0	2.3-2.3/1.15	23	11.56	N	
3/4	3600	208-230/460	56C	N569	056T34V5306	✓	1000:1	\$480	F3	75.5	2.6-2.4/1.2	50	11.08	N	
	1800	208-230/460	56C	N599	056T17V5338	✓	1000:1	\$567	F3	80.0	2.5-2.5/1.25	31	10.56	N	
	1800	208-230/460	56C	N633	056T17W99004	✓	10:1	\$567	F3	77.0	2.9-2.8/1.4	26	11.19	V	
	1800	575	56C	N623	056T17W5339	✓	10:1	\$567	F3	77.0	1.1	31	11.19	V	
1	1200	208-230/460	56C	N600	056T11V5377	✓	1000:1	\$665	F3	78.5	3.0-3.0/1.5	25	13.06	N,5	
	3600	208-230/460	56C	N601	056T34V5307	✓	1000:1	\$561	F3	78.5	2.8-2.6/1.3	35	11.56	N	
	1800	208-230/460	56C	N602	056T17V5340	✓	1000:1	\$591	F3	80.0	3.2-3.2/1.6	35	11.58	N	
	1800	575	56C	EG311	5KS49UN4598	✓	10:1	\$591	F3	82.5	1.2	39	12.08	d	
	1800	575	56C	N627	056T17W5341	✓	10:1	\$591	F3	77.0	1.5	29	11.69	V	
	1800	208-230/460	143TC	N626A	143TTWR6028	✓	10:1	\$691	F3	85.5	3.2-3.1/1.55	35	12.75	V	
	1200	208-230/460	56HC	N604	056T11W5377	✓	10:1	\$713	F3	78.5	4.0-4.0/2.0	36	13.06	5,V	
	1 1/2	3600	208-230/460	56C	N605	056T34V5308	✓	1000:1	\$620	F3	80.0	4.2-3.8/1.9	43	12.56	N
1	1800	208-230/460	56C	K2067	5KE49TN4597	✓	10:1	\$617	F3	84.0	5.3-4.4/2.2	40	13.19	d	
	1800	208-230/460	56C	N606	056T17V5342	✓	1000:1	\$617	F3	84.0	4.2-4.2/2.1	47	13.06	N	
	1800	208-230/460	145TC	N607	145TTVR5326	✓	1000:1	\$617	F3	84.0	4.2-4.2/2.1	48	13.12	N	
	1800	575	145TC	N629	145TTVR5030	✓	1000:1	\$617	F3	84.0	1.8	42	13.12	N	
	1200	208-230/460	56HC	N608	056T11W5378	✓	10:1	\$753	F3	77.0	5.7-5.7/2.85	50	14.18	5,V	
	2	3600	208-230/460	56HC	N609	056T34V5309	✓	1000:1	\$688	F3	82.5	5.6-5.0/2.5	49	13.06	N,5,17
	3600	208-230/460	145TC	N610	145TTVR5302	✓	1000:1	\$763	F3	84.0	5.6-5.0/2.5	49	13.12	N	
	1800	208-230/460	56C	N611	056T17W5327	✓	10:1	\$708	F3	81.5	6.2-6.2/3.1	38	12.69	V	
1	1800	575	145TC	N630	145TTWR6033	✓	10:1	\$852	F3	86.5	2.3	46	13.75	V	
	1800	208-230/460	145TC	N612A	145TTWR6026	✓	10:1	\$852	F3	86.5	6.0-5.6/2.8	46	13.75	V	
	3	3600	208-230/460	145TC	N613A	145TTWR6001	✓	10:1	\$1,126	F3	89.5	8.4-7.6/3.8	46	13.75	V
	3600	208-230/460	182TC	N634	182TTWW16002	✓	10:1	\$1,337	F3	86.5	8.2-7.6/3.8	80	14.97	V,13	
1	1800	208-230/460	182TC	N614B	182TTWW6026	✓	10:1	\$1,255	F3	89.5	8.6-7.8/3.9	80	14.47	V	
	5	3600	208-230/460	184TC	N615B	184TTWW6001	✓	10:1	\$1,570	F3	88.5	13.2-12.0/6.0	79	14.47	V
	1800	208-230/460	184TC	N616B	184TTWW6026	✓	10:1	\$1,417	F3	88.5	13.6-12.8/6.4	84	14.97	V	
7 1/2	3600	208-230/460	213TC	N617A	213TTWR6002	✓	10:1	\$1,950	F3	89.5	18.6-17.8/8.9	140	17.47	V	
	3600	208-230/460	184TC	N635	184TTWW16002	✓	10:1	\$1,805	F3	89.5	19.2-17.6/8.8	94	15.97	V,13	
	1800	208-230/460	213TC	N618A	213TTWR6026	✓	10:1	\$1,797	F3	91.7	23.4-21.4/10.7	135	17.71	V	
10	3600	208-230/460	215TC	N637	215TTWW16003	✓	10:1	\$2,240	F3	90.2	24.5-23.6/11.8	129	20.57	V	
	1800	208-230/460	215TC	N619A	215TTWR6026	✓	10:1	\$2,043	F3	91.7	27.6-26.6/13.3	145	18.71	V	

Catalog numbers (Cat No.) highlighted in bold blue have efficiency levels that meet EISA requirements

* Requires nameplate modification

WASHDOWN - Painted and Stainless Steel

PowerWash™ XT Washdown Duty, Three Phase

White Epoxy, Totally Enclosed

Close Coupled Pump, JM, Rigid Base

Same features as shown on page 106

HP	RPM	VOLTS	FRAME	CAT. NO.	MODEL NO.	STOCK	CT SPEED RANGE*	LIST PRICE	MULT. SYMB.	NOM. EFF.	F.L. AMPS	WEIGHT	"C" DIM.	FOOT NOTES
1	1800	208-230/460	143JM	N201	143TTWR14032	✓	10:1	\$750	F3	82.5	3.2-3.1/1.55	41	16.25	
1 1/2	3600	208-230/460	143JM	N202	143TTWR14002	✓	10:1	\$774	F3	82.5	4.4-4.0/2.0	33	16.25	
	1800	208-230/460	145JM	N203	143TTWR14031	✓	10:1	\$792	F3	84.0	4.5-4.4/2.2	47	16.25	
2	3600	208-230/460	145JM	N204	145TTWR14003	✓	10:1	\$806	F3	84.0	5.6-5.2/2.6	50	16.25	
	1800	208-230/460	145JM	N205	145TTWR14031	✓	10:1	\$824	F3	84.0	6.0-5.6/2.8	49	16.75	
3	3600	208-230/460	145JM	N206	145TTWR14004	✓	10:1	\$837	F3	85.5	8.4-7.6/3.8	54	16.75	
	1800	208-230/460	182JM	N207	182TTWW14031	✓	10:1	\$1,373	F3	87.5	8.0-8.6/4.3	79	16.75	13
5	3600	208-230/460	184JM	N208	184TTWW14005	✓	10:1	\$1,503	F3	87.5	13.0-12.0/6.0	81	16.75	13
	1800	208-230/460	184JM	N209	184TTWW14031	✓	10:1	\$1,427	F3	87.5	14.0-13.0/6.5	995	17.63	13
7 1/2	3600	208-230/460	184JM	N210	184TTWW14004	✓	10:1	\$1,400	F3	88.5	17.6-16.8/8.4	110	18.25	13
	1800	208-230/460	213JM	N211	213TTWW14031	✓	10:1	\$2,412	F3	89.5	24.0-22.0/11.0	135	19.50	
10	3600	208-230/460	215JM	N212	215TTWW14009	✓	10:1	\$2,345	F3	89.5	27.0-24.0/12.0	142	22.20	
	1800	208-230/460	215JM	N213	215TTWW14031	✓	10:1	\$2,302	F3	89.5	29.0-28.0/14.0	150	21.70	
15	3600	208-230/460	215JM	N214	215TTWW14007	✓	10:1	\$2,716	F3	90.2	37.0-36.0/18.0	160	22.20	

Centrifugal Pump (Jet Pump), C-Face Footless, 56J

HP	RPM	VOLTS	FRAME	CAT. NO.	MODEL NO.	STOCK	CT SPEED RANGE*	LIST PRICE	MULT. SYMB.	NOM. EFF.	F.L. AMPS	WEIGHT	"C" DIM.	FOOT NOTES
3/4	3600	208-230/460	56J	N230	056T34W99007	✓	10:1	\$523	F3	75.5	2.5-2.4/1.2	23	10.81	
1	3600	208-230/460	56J	N232	056T34W99010	✓	10:1	\$574	F3	77.0	3.4-3.2/1.6	35	10.81	
1 1/2	3600	208-230/460	56J	N234	056T34W99011	✓	10:1	\$619	F3	81.5	4.4-4.2/2.1	42	11.81	
2	3600	208-230/460	56J	N236	056T34W99008	✓	10:1	\$662	F3	82.5	5.8-5.6/2.8	47	12.31	
3	3600	208-230/460	56J	N238	056T34W99012	✓	10:1	\$714	F3	84.0	8.4-7.6/3.8	49	13.25	

Centrifugal Pump (Jet Pump), C-Face Footed (Rigid Base), 56J

HP	RPM	VOLTS	FRAME	CAT. NO.	MODEL NO.	STOCK	CT SPEED RANGE*	LIST PRICE	MULT. SYMB.	NOM. EFF.	F.L. AMPS	WEIGHT	"C" DIM.	FOOT NOTES
3/4	3600	208-230/460	56J	N220	056T34W99003	✓	10:1	\$554	F3	75.5	2.5-2.4/1.2	24	10.81	
1	3600	208-230/460	56J	N222	056T34W99004	✓	10:1	\$599	F3	77.0	3.4-3.2/1.6	36	10.81	
1 1/2	3600	208-230/460	56J	N224	056T34W99005	✓	10:1	\$632	F3	81.5	4.4-4.2/2.1	43	11.81	
2	3600	208-230/460	56J	N226	056T34W99006	✓	10:1	\$689	F3	82.5	5.8-5.6/2.8	48	12.31	
3	3600	208-230/460	56J	N228	056T34W99009	✓	10:1	\$735	F3	84.0	8.4-7.6/3.8	50	13.25	

Brakemotor C-Face Footless

HP	RPM	VOLTS	FRAME	CAT. NO.	MODEL NO.	STOCK	CT SPEED RANGE*	LIST PRICE	MULT. SYMB.	NOM. EFF.	F.L. AMPS	WEIGHT	"C" DIM.	BRAKE RATING (Lb/Ft)	FOOT NOTES
1/3	1800	208-230/460	56C	N371	056T17V99003	✓	1000:1	\$747	F3	72.0	1.4-1.3/65	39	14.00	3	N
1/2	1800	208-230/460	56C	N373	056T17V99004	✓	1000:1	\$766	F3	78.5	2.0-1.8/9	41	14.50	3	N
3/4	1800	208-230/460	56C	N375	056T17V99002	✓	1000:1	\$911	F3	80.0	2.7-2.5/1.25	43	15.00	6	N
1	1800	208-230/460	56C	N377	056T17V99009	✓	1000:1	\$944	F3	80.0	3.3-3.2/1.6	45	15.50	6	N
	1800	208-230/460	143TC	N378	143TTVR5330	✓	1000:1	\$944	F3	80.0	3.3-3.2/1.6	46	15.56	6	N
1 1/2	1800	208-230/460	145TC	N380	145TTWR17031	✓	10:1	\$1,308	F3	87.5	4.6-5.0/2.5	49	18.01	10	V,5
	2	1800	208-230/460	145TC	N382	145TTWR17032	✓	10:1	\$1,345	F3	81.5	6.2-6.2/3.1	61	18.51	10

Brakemotor C-Face Footed (Rigid Base)

HP	RPM	VOLTS	FRAME	CAT. NO.	MODEL NO.	STOCK	CT SPEED RANGE*	LIST PRICE	MULT. SYMB.	NOM. EFF.	F.L. AMPS	WEIGHT	"C" DIM.	BRAKE RATING (Lb/Ft)	FOOT NOTES
1/3	1800	208-230/460	56C	N351	056T17V99006	✓	1000:1	\$774	F3	72.0	1.4-1.3/65	40	14.00	3	N
1/2	1800	208-230/460	56C	N353	056T17V99007	✓	1000:1	\$789	F3	78.5	2.0-1.8/9	42	14.50	3	N
3/4	1800	208-230/460	56C	N355	056T17V99008	✓	1000:1	\$937	F3	80.0	2.7-2.5/1.25	44	15.00	6	N
1	1800	208-230/460	56C	N357	056T17V99005	✓	1000:1	\$968	F3	80.0	3.3-3.2/1.6	48	15.50	6	N
	1800	208-230/460	143TC	N358	143TTVR5331	✓	1000:1	\$968	F3	80.0	3.3-3.2/1.6	49	16.06	6	N
1 1/2	1800	208-230/460	145TC	N360	145TTWR14032	✓	10:1	\$1,342	F3	84.0	4.5-4.4/2.2	50	19.01	10	V,5
2	1800	208-230/460	145TC	N362	145TTWR14033	✓	10:1	\$1,391	F3	84.0	6-5.6/2.8	62	19.01	10	V,5

Catalog numbers (Cat No.) highlighted in bold blue have efficiency levels that meet EISA requirements

PowerWash™ SXT Washdown Duty, Single Phase

All Stainless Steel, Totally Enclosed

Features:

- Encapsulated electronic starting switch is impervious to moisture
- Capacitor start induction run design for high starting torque unless otherwise noted
- 1.15 Service Factor on sinewave
- Double sealed ball bearings
- 303 stainless steel shaft with spring loaded contact seals in each end.
- 300 Series Stainless steel external construction: frame, endshields, conduit box, fan guard, mounting base and hardware for superior corrosion resistance
- Internal corrosion resistant coatings on rotor and heavy polyester varnish on the stator.
- 100% Paint-free constructions
- One way condensation drains in each endshield and conduit box for all angle mounting
- Nitrile Buna - N gaskets and seals on conduit box, through bolts and endshields
- Nameplate information laser etched on frame
- UL Recognized, CSA Certified and CE Mark



C-Face Footed (Rigid Base)

HP	RPM	VOLTS	FRAME	CAT. NO.	MODEL NO.	STOCK	LIST PRICE	MULT. SYMB.	F.L. AMPS	WEIGHT	"C" DIM.	FOOT NOTES
1/2	3600	115/208-230	56C	N340	056C34WD5301	✓	\$471	F3	7.4/3.7	29.5	11.10	
	1800	115/208-230	56C	N341	056C17WD5327	✓	\$531	F3	8.2/4.1	31.5	11.10	
3/4	3600	115/208-230	56C	N342	056C34WD5302	✓	\$518	F3	9.2/4.6	31.5	11.80	
	1800	115/208-230	56C	N343	056C17WD5328	✓	\$613	F3	9.8/4.9	39.0	11.80	
1	3600	115/208-230	56C	N344	056C34WD5303	✓	\$609	F3	12.4/6.2	39.0	12.30	
	1800	115/208-230	56C	N345	056C17WD5329	✓	\$639	F3	13.6/6.8	42.5	12.30	
1 1/2	3600	115/208-230	56C	N346	056C34WD5304	✓	\$670	F3	16.4/8.5-8.2	42.5	13.20	
	1800	115/208-230	56C	N347	056C17WD5330	✓	\$668	F3	15.8/7.9	52.5	13.20	
2	3600	115/208-230	145TC	N348	145TBWD5305	✓	\$865	F3	19/9.5	64.5	14.20	
	1800	115/208-230	145TC	N349	145TBWD5335	✓	\$847	F3	16.4/8.2	64.5	14.20	

WASHDOWN - Painted and Stainless Steel

PowerWash™ SXT Washdown Duty, Three Phase

All Stainless Steel, Totally Enclosed

Features:

- Suitable for use on VFD 10:1 Variable torque, 10:1 (TEFC) or 1000:1 (TENV) Constant Torque
- MAX GUARD® Class F insulation system
- 1.15 Service Factor on sinewave, 1.0 Service Factor on IGBT power
- Double sealed ball bearings
- 303 stainless steel shaft with spring loaded contact seals in each end.
(Drive end only on TENV)
- 300 Series Stainless steel external construction: frame, endshields, conduit box, mounting base and hardware for superior corrosion resistance
- Internal corrosion resistant coatings on rotor and heavy polyester varnish on the stator
- 100% Paint-free construction
- One way condensation drains in each endshield and conduit box for all angle mounting
- Nitrile Buna - N gaskets and seals on conduit box, through bolts and endshields
- Rated 60/50 hertz, 190/380 volt at next lower horsepower
- Nameplate information laser etched on frame
- UL Recognized, CSA Certified and CE Mark



C-Face Footless

Suitable for use on VFD per guidelines on page 17.

HP	RPM	VOLTS	FRAME	CAT. NO.	MODEL NO.	STOCK	LIST PRICE	MULT. SYMB.	NOM. EFF.	F.L. AMPS	WEIGHT	"C" DIM.	FOOT NOTES
1/3	1800	208-230/460	56C	N430	56T17VD5329	✓	\$512	F3	78.5	1.2-1.3/65	30	9.78	N
1/2	1800	208-230/460	56C	N431	56T17VD5330	✓	\$525	F3	81.5	1.5-1.6/1.8	33	9.78	N
	1200	208-230/460	56C	N426	056T11VD5378		\$611	F3	78.5	2.1-2.0/1.0	35	9.76	N
3/4	1800	208-230/460	56C	N432	56T17VD5331	✓	\$610	F3	82.5	2.4-2.3/1.2	38	9.78	N
	1200	208-230/460	56C	N427	056T11VD5379		\$689	F3	80.0	3.0-3.0/1.5	47	11.30	N
1	1800	208-230/460	56C	N428	056T17VD5332		\$636	F3	81.5	3.1-3.0/1.5	45	11.00	N
	1800	208-230/460	56C	N433	56T17WD5330	✓	\$636	F3	82.5	3.2-3.0/1.5	47	13.77	
	1800	208-230/460	143TC	N434A	143TTWD4527	✓	\$705	F3	85.5	3.2-3.0/1.5	47	13.62	
	1200	208-230/460	56C	N429	056T11WD5379		\$718	F3	82.5	3.8-3.8/1.9	47	13.10	
1 1/2	1800	208-230/460	56C	N435	56T17WD5331	✓	\$664	F3	84.0	5.8-5.4/4.4	48	13.77	
	1800	208-230/460	145TC	N436A	145TTWD6031		\$754	F3	84.0	5.0-4.8/2.4	48	13.62	
2	1800	208-230/460	56C	N437	56T17WD5332	✓	\$758	F3	84.0	6.2-5.8/2.9	52	13.77	
	1800	208-230/460	145TC	N438A	145TTWD4528	✓	\$838	F3	84.0	6.2-5.8/2.9	52	13.62	

Catalog numbers (Cat No.) highlighted in bold blue have efficiency levels that meet EISA requirements

Continued on next page.

WASHDOWN - Painted and Stainless Steel

PowerWash™ SXT Washdown Duty, Three Phase

All Stainless Steel, Totally Enclosed

Features:

- Suitable for use on VFD 10:1 Variable torque, 10:1 (TEFC) or 1000:1 (TENV) Constant Torque
- MAX GUARD® Class F insulation system
- 1.15 Service Factor on sinewave, 1.0 Service Factor on IGBT power
- Double sealed ball bearings
- 303 stainless steel shaft with spring loaded contact seals in each end. (Drive end only on TENV)
- 300 Series Stainless steel external construction: frame, endshields, conduit box, mounting base and hardware for superior corrosion resistance
- Internal corrosion resistant coatings on rotor and heavy polyester varnish on the stator
- 100% Paint-free construction
- One way condensation drains in each endshield and conduit box for all angle mounting
- Nitrile Buna - N gaskets and seals on conduit box, through bolts and endshields
- Rated 60/50 hertz, 190/380 volt at next lower horsepower
- Nameplate information laser etched on frame
- UL Recognized, CSA Certified and CE Mark



C-Face Footed (Rigid Base)

Suitable for use on VFD per guidelines on page 17.

HP	RPM	VOLTS	FRAME	CAT. NO.	MODEL NO.	STOCK	LIST PRICE	MULT. SYMB.	NOM. EFF.	F.L. AMPS	WEIGHT	"C" DIM.	FOOT NOTES
1/3	3600	208-230/460	56C	N450	56T34VD5301	✓	\$461	F3	74.0	1.1-1.0/0.5	29	9.78	N
	1800	208-230/460	56C	N410	56T17VD5326	✓	\$515	F3	78.5	1.2-1.3/.65	30	9.78	N
1/2	3600	208-230/460	56C	N451	56T34VD5302	✓	\$471	F3	77.0	1.6-1.5/.75	32	9.78	N
	1800	208-230/460	56C	N411	56T17VD5328	✓	\$530	F3	81.5	1.5-1.6/.8	33	9.78	N
	1800	208-230/460	56C	N494	056T17WD5338		\$530	F3	81.5	1.5-1.6/.8	34	13.77	
	1200	208-230/460	56C	N495	056T11VD5385		\$649	F3	78.5	2.2-2.0/1.0	36	9.79	N
3/4	3600	208-230/460	56C	N452	56T34VD5303	✓	\$517	F3	78.5	2.2-2.0/1.0	33	9.78	N
	1800	208-230/460	56C	N412	56T17VD5327	✓	\$613	F3	82.5	2.4-2.3/1.15	38	9.78	N
	1800	208-230/460	56C	N496	056T17WD5337		\$613	F3	82.5	2.4-2.3/1.2	39	13.77	
	1200	208-230/460	56C	N497	056T11WD5386		\$728	F3	80.0	3.2-3.0/1.5	49	11.30	N
1	3600	208-230/460	56HC	N453	56T34WD5301	✓	\$608	F3	80.0	2.9-2.6/1.3	41	13.77	5
	3600	208-230/460	143TC	N454A	143TTWD6001	✓	\$764	F3	80.0	2.9-2.6/1.3	42	13.62	
	1800	208-230/460	56C	N413	56T17WD5326	✓	\$638	F3	81.5	3.2-3.0/1.5	46	11.00	5
	1800	208-230/460	56HC	N419	056T17WD5336		\$638	F3	82.5	3.2-3.0/1.5	47	13.77	5
	1800	208-230/460	143TC	N414A	143TTWD6026	✓	\$858	F3	85.5	3.2-3.0/1.5	48	13.62	
	1200	208-230/460	56HC	N498	056T11WD5387		\$811	F3	82.5	4.2-3.8/1.9	49	13.10	5
	1200	208-230/460	145TC	N499	145TTWD6077		\$1,021	F3	82.5	4.2-3.8/1.9	49	13.20	
	1 1/2	3600	208-230/460	56HC	N455	56T34WD5302	✓	\$670	F3	82.5	4.2-3.8/1.9	48	13.77
1 1/2	3600	208-230/460	143TC	N456	143TTWD4002	✓	\$726	F3	82.5	4.2-3.8/1.9	48	13.87	d
	3600	208-230/460	143TC	N456A	143TTWD6002	✓	\$902	F3	84.0	4.2-3.8/1.9	49	13.62	
	1800	208-230/460	56HC	N415	56T17WD5329	✓	\$666	F3	84.0	5.0-4.8/2.4	40	13.77	5
	1800	208-230/460	145TC	N416A	145TTWD6028		\$892	F3	86.5	5.0-4.8/2.4	49	13.62	
	2	3600	208-230/460	56HC	N457	56T34WD5303	✓	\$743	F3	84.0	5.6-5.0/2.5	49	13.77
2	3600	208-230/460	145TC	N458A	145TTWD6001	✓	\$1,081	F3	85.5	5.6-5.0/2.5	50	13.62	
	1800	208-230/460	56HC	N417	56T17WD5328	✓	\$760	F3	84.0	6.2-5.8/2.9	52	13.77	5
	1800	208-230/460	145TC	N418A	145TTWD6029	✓	\$1,059	F3	86.5	6.2-5.8/2.9	53	13.62	
3	3600	208-230/460	145TC	N459	145TTWD6030		\$1,247	F3	86.5	8.0-7.2/3.6	62	14.12	

Catalog numbers (Cat No.) highlighted in bold blue have efficiency levels that meet EISA requirements

WASHDOWN - Painted and Stainless Steel

PowerWash™ SXT-Plus Washdown Duty, Single Phase

Stainless/BISSC, Totally Enclosed

Features:

- Encapsulated electronic starting switch is impervious to moisture
- Capacitor start induction run design for high starting torque, except as noted
- 1.15 Service Factor on sinewave
- Double sealed ball bearings with moisture resistant, high temperature grease
- 303 stainless steel shaft with spring loaded contact seals in each end.
- 300 Series Stainless steel external construction: frame, endshields, conduit box, fan guard, mounting base and hardware for superior corrosion resistance
- Internal corrosion resistant coatings on rotor and heavy polyester varnish on the stator.
- 100% Paint-free constructions
- Viton® o-rings, shaft seals, and gaskets for superior sealing against chemicals
- Hydrophobic breather in OP endshield and conduit box equalize air pressure
- Nameplate information laser etched on frame
- BISSC Certified for baking industry
- UL Recognized, CSA Certified and CE Mark



IP56

C-Face Footless

HP	RPM	VOLTS	FRAME	CAT. NO.	MODEL NO.	STOCK	LIST PRICE	MULT. SYMB.	F.L. AMPS	WEIGHT	"C" DIM.	FOOT NOTES
1/3	1800	115/208-230	56C	N270	056C17V5304	✓	\$689	F3	5.4/3.0-2.7	35	11.70	N
1/2	1800	115/208-230	56C	N271	056C17V5302	✓	\$832	F3	6.6/3.5-3.3	38	12.70	N
3/4	1800	115/208-230	56C	N272	056B17V5301	✓	\$929	F3	7.6/4.2-3.8	42	12.70	N,1
1	1800	115/208-230	56C	N273	056B17V5302	✓	\$949	F3	9.0/5.0-4.5	49	13.70	N,1
1 1/2	1800	115/208-230	145TC	N274	145TBWD5327	✓	\$1,012	F3	14.8/7.8-7.4	53	14.87	1
2	1800	115/208-230	145TC	N275	145TBWD5326	✓	\$1,243	F3	20.0/10.2-10.0	57	14.87	1

C-Face Footed (Rigid Base)

HP	RPM	VOLTS	FRAME	CAT. NO.	MODEL NO.	STOCK	LIST PRICE	MULT. SYMB.	F.L. AMPS	WEIGHT	"C" DIM.	FOOT NOTES
1/3	1800	115/208-230	56HC	N280	056C17V5303	✓	\$692	F3	5.4/3.0-2.7	35	12.20	N,5
1/2	3600	115/208-230	56HC	N281	056C34V5302	✓	\$807	F3	7.6/4.0-3.8	38	12.20	N,5
	1800	115/208-230	56HC	N282	056C17V5301	✓	\$840	F3	6.6/3.5-3.3	38	12.70	N,5
3/4	1800	115/208-230	56HC	N283	056B17V5303	✓	\$937	F3	7.6/4.2-3.8	42	12.70	N,1,5
1	3600	115/208-230	56HC	N284	056C34V5301	✓	\$899	F3	12.0/6.8-6.0	49	13.70	N,5
	1800	115/208-230	56HC	N285	056B17V5304	✓	\$962	F3	9.0/5.0-4.5	49	13.70	N,1,5
1 1/2	3600	115/208-230	56HC	N286	056B34W5301	✓	\$947	F3	13.6/7.2-6.8	49	13.81	V,1
	1800	115/208-230	145TC	N287	145TBWD5329	✓	\$1,020	F3	14.8/7.8-7.4	53	14.81	V,1
2	3600	115/208-230	145TC	N288	145TBWD5301	✓	\$1,128	F3	17.6/9.8-8.8	57	14.81	V,1
	1800	115/208-230	145TC	N289	145TBWD5328	✓	\$1,251	F3	20.0/10.2-10.0	57	14.81	V,1

WASHDOWN - Painted and Stainless Steel

PowerWash™ SXT-Plus Washdown Duty, Three Phase

Stainless/BISSC, Totally Enclosed

Features:

- Suitable for use on VFD, 10:1 Variable torque, 10:1 (TEFC) or 1000:1 (TENV) Constant Torque, 1.0 Service Factor
- MAX GUARD® Class F insulation system
- 1.15 Service Factor on sinewave, 1.0 Service Factor on IGBT power
- Double sealed ball bearings with moisture resistant, high temperature grease
- 300 Series Stainless steel external construction: frame, endshields, shaft, conduit box, mounting base and hardware for superior corrosion resistance
- Internal corrosion resistant coatings on rotor and heavy polyester varnish on the stator
- 100% Paint-free construction
- Viton® o-rings, shaft seals, and gaskets for superior sealing against chemicals
- Hydrophobic breather in OP endshield and conduit box equalize air pressure
- Nameplate information laser etched on frame
- BISSC Certified for baking industry
- UL Recognized, CSA Certified and CE Mark



C-Face Footless

Suitable for use on VFD per guidelines on page 17.

HP	RPM	VOLTS	FRAME	CAT. NO.	MODEL NO.	STOCK	LIST PRICE	MULT. SYMB.	NOM. EFF.	F.L. AMPS	WEIGHT	"C" DIM.	FOOT NOTES
1/3	1800	208-230/460	48C	N460	048T17V2001	✓	\$896	F3	70.5	1.3-1.3/65	25	9.83	N
1/2	3600	208-230/460	56C	N480A	056T34V5316	✓	\$841	F3	82.5	1.7-1.6/8	35	12.04	N
	1800	208-230/460	48C	N461	048T17V2002	✓	\$919	F3	76.0	1.9-1.8/0.9	27	11.58	N
	1800	208-230/460	56C	N462A	056T17V5353	✓	\$975	F3	78.5	1.7-1.6/8	34	12.54	N
3/4	3600	208-230/460	56C	N481A	056T34V5317	✓	\$925	F3	84.0	2.6-2.4/1.2	40	12.54	N
	1800	208-230/460	56C	N463A	056T17V5352	✓	\$998	F3	80.0	2.4-2.3/1.2	40	13.04	N
1	3600	208-230/460	56C	N482A	056T34V5313	✓	\$982	F3	85.5	2.8-2.6/1.3	43	13.04	N
	1800	208-230/460	56C	N464A	056T17V5356	✓	\$1,113	F3	81.5	3.1-3/1.5	44	13.54	N
	1800	208-230/460	56HC	N465A	056T17W5331	✓	\$1,113	F3	82.5	3.2-3.1/1.6	45	13.13	5
	1800	208-230/460	143TC	N466	143TTVD5327	✓	\$1,234	F3	81.5	3.1-3.0/1.5	44	13.61	N
	1800	208-230/460	143TC	N467	143TTWD14032	✓	\$1,272	F3	82.5	3.2-3.1/1.55	51	13.19	V
1 1/2	3600	208-230/460	143TC	N483	143TTWD14003	✓	\$1,005	F3	82.5	4.4-4.4-4/2	52	13.69	V
	1800	208-230/460	56C	N468A	056T17W5330	✓	\$1,162	F3	84.0	4.5-4.4/2.2	49	13.63	V
	1800	208-230/460	145TC	N469	145TTWD14034	✓	\$1,323	F3	84.0	4.5-4.4/2.2	55	13.69	V
2	3600	208-230/460	145TC	N484	145TTWD14005	✓	\$1,099	F3	84.0	5.6-5.2/2.6	54	13.69	V
	1800	208-230/460	56C	N470A	056T17W5332	✓	\$1,187	F3	84.0	6.0-5.6/2.8	49	13.63	V
	1800	208-230/460	145TC	N471	145TTWD14033	✓	\$1,347	F3	84.0	6.0-5.6/2.8	60	13.69	V
3	3600	208-230/460	145TC	N485	145TTWD14004	✓	\$1,215	F3	85.5	8.4-7.6/3.8	55	13.69	V
	1800	208-230/460	182TC	N448A	182TTWD14032	✓	\$1,809	F3	87.5	8.0-8.6/4.3	88	14.77	V
5	3600	208-230/460	184TC	N486	184TTWD14002	✓	\$1,587	F3	87.5	13.0-12.0/6.0	98	14.77	V,13
	1800	208-230/460	184TC	N449A	184TTWD14032	✓	\$1,998	F3	87.5	14.0-13.0/6.5	102	15.27	V,13

Catalog numbers (Cat No.) highlighted in bold blue have efficiency levels that meet EISA requirements

Continued on next page.

WASHDOWN - Painted and Stainless Steel

PowerWash™ SXT-Plus Washdown Duty, Three Phase

Stainless/BISSC, Totally Enclosed

C-Face Footed (Rigid Base)

Same features as shown on page 114

HP	RPM	VOLTS	FRAME	CAT. NO.	MODEL NO.	STOCK	LIST PRICE	MULT. SYMB.	NOM. EFF.	F.L. AMPS	WEIGHT	"C" DIM.	FOOT NOTES
1/2	3600	208-230/460	56HC	N439A	056T34V5314	✓	\$857	F3	82.5	1.7-1.6/8	35	12.04	N,5
	1800	208-230/460	56HC	N400	056T17V5347	✓	\$966	F3	78.0	1.6-1.6/8	37	12.54	N,5
	1200	208-230/460	56HC	N180A	056T11V5379	✓	\$963	F3	77.0	2.4-2.3/1.2	35	12.54	N,5
3/4	3600	208-230/460	56HC	N442A	056T34V5312	✓	\$941	F3	84.0	2.6-2.4/1.2	40	12.54	N,5
	1800	208-230/460	56HC	N401	056T17V5348	✓	\$1,003	F3	80.0	2.4-2.3/1.15	42	13.04	N,5
	1200	208-230/460	56HC	N181A	056T11V5380	✓	\$1,012	F3	78.5	3.1-3.0/1.5	46	14.04	N,5
1	3600	208-230/460	56HC	N441A	056T34V5315	✓	\$1,107	F3	85.5	2.8-2.6/1.3	43	13.04	N,5
	1800	208-230/460	56HC	N402	056T17V5349	✓	\$1,026	F3	81.5	2.4-2.3/1.15	47	13.54	N,5
	1800	208-230/460	56HC	N291	056T17W5329	✓	\$1,026	F3	82.5	3.2-3.1/1.6	39	13.13	V,5
	1800	208-230/460	143TC	N403	143TTVD5326	✓	\$1,026	F3	81.5	3.1-3.0/1.5	50	13.61	N
	1800	208-230/460	143TC	N292	143TTWD16031	✓	\$1,026	F3	85.5	3.2-3.2/1.6	50	13.19	
	1200	208-230/460	56HC	N182A	056T11W5379	✓	\$1,065	F3	77.0	3.8-4.0/2.0	48	13.13	5
1 1/2	3600	208-230/460	143TC	N440A	143TTWD16002	✓	\$1,321	F3	84.0	4.4-4.0/2.0	45	13.69	
	1800	208-230/460	56HC	N293	056T17W5336	✓	\$1,098	F3	84.0	4.5-4.4/2.2	49	13.63	5
	1800	208-230/460	145TC	N404A	145TTWD6026	✓	\$1,200	F3	86.5	4.5-4.4/2.2	52	13.69	
	1200	208-230/460	56HC	N183A	056T11W5380	✓	\$1,287	F3	80.0	5.9-5.4/2.7	51	14.13	5
2	3600	208-230/460	145TC	N443A	145TTWD16003	✓	\$1,967	F3	85.5	5.2-4.8/2.4	49	13.69	
	1800	208-230/460	56HC	N294	056T17W5337	✓	\$1,383	F3	84.0	6.0-5.6/2.8	50	13.63	5
	1800	208-230/460	145TC	N405A	145TTWD6027	✓	\$1,491	F3	86.5	5.6-5.6/2.8	50	13.69	
3	3600	208-230/460	145TC	N444	145TTWD16002	✓	\$2,007	F3	86.5	8.8-8.0/4.0	53	13.69	
	1800	208-230/460	182TC	N406A	182TTWD6031	✓	\$1,791	F3	89.5	8.8-8.2/4.1	85	14.77	13
5	3600	208-230/460	184TC	N445A	184TTWD16002	✓	\$2,247	F3	88.5	13.0-12.0/6.0	90	14.77	13
	1800	208-230/460	184TC	N407A	184TTWD6031	✓	\$2,043	F3	89.5	13.8-13.0/6.5	96	15.27	13
7 1/2	3600	208-230/460	213TC	N446A	213TTWD16002	✓	\$2,956	F3	89.5	19.6-17.8/8.9	160	18.69	
	1800	208-230/460	213TC	N408A	213TTWD6031	✓	\$3,056	F3	91.7	22.4-20.4/10.8	160	18.69	
10	3600	208-230/460	215TC	N447A	215TTWD16002	✓	\$3,087	F3	90.2	26.4-23.6/11.8	165	18.69	
	1800	208-230/460	215TC	N409A	215TTWD6031	✓	\$3,148	F3	91.7	28.0-26.0/13.0	173	18.69	

Catalog numbers (Cat No.) highlighted in bold blue have efficiency levels that meet EISA requirements

PowerWash™ Coupler Brakes

PowerWash™ coupler brakes are specifically designed for use with PowerWash™ Washdown Duty motors. Rated for NEMA 4X/IP55, these brakes are suitable for applications with high moisture or pressure washdown. Painted with a special white epoxy food-safe paint, these brakes are **BISSC Certified**.

ENCLOSURE NEMA 4X/IP55	CAT. NO.	KIT NO.	STOCK	LIST PRICE	MULT. SYMB.	WEIGHT
3 Lb/Ft	A909	KIT 909	✓	\$755	S4	12
6 Lb/Ft	A910	KIT 910	✓	\$816	S4	12
10 Lb/Ft	A911	KIT 911	✓	\$897	S4	12

Continued on next page.

PowerWash™ SXT-Plus Washdown Duty, Three Phase

Stainless/BISSC, Totally Enclosed



Close Coupled Pump, JM, Rigid Base

Same features as shown on page 114

HP	RPM	VOLTS	FRAME	CAT. NO.	MODEL NO.	STOCK	LIST PRICE	MULT. SYMB.	NOM. EFF.	F.L. AMPS	WEIGHT	"C" DIM.	FOOT NOTES
1	1800	208-230/460	143JM	N151	143TTWD14031	✓	\$823	F3	82.5	3.2-3.1/1.55	55	16.00	V
1 1/2	3600	208-230/460	143JM	N152	143TTWD14002	✓	\$823	F3	82.4	4.4-4.0/2.0	55	16.00	V
	1800	208-230/460	145JM	N153	145TTWD14031	✓	\$840	F3	84.0	4.5-4.4/2.2	56	16.00	V
2	3600	208-230/460	145JM	N154	145TTWD14002	✓	\$978	F3	84.0	5.6-5.2/2.6	56	16.00	V
	1800	208-230/460	145JM	N155	145TTWD14032	✓	\$988	F3	84.0	6.0-5.6/2.8	57	16.50	V
3	3600	208-230/460	145JM	N156	145TTWD14003	✓	\$1,176	F3	85.5	8.4-7.6/3.8	57	16.50	V
	1800	208-230/460	182JM	N157	182TTWD14033	✓	\$1,244	F3	87.5	8.0-8.6/4.3	85	16.20	V,13
5	3600	208-230/460	184JM	N158	184TTWD14003	✓	\$1,372	F3	87.5	13.0-12.0/6.0	90	16.20	V,13
	1800	208-230/460	184JM	N159	184TTWD14033	✓	\$1,379	F3	87.5	14.0-13.0/6.5	96	16.77	V,13
7 1/2	3600	208-230/460	213JM	N160	213TTWD14002	✓	\$2,089	F3	88.5	20.0-18.4/9.2	160	16.81	V
	1800	208-230/460	213JM	N161	213TTWD14032	✓	\$2,135	F3	89.5	24.0-22.0/11.0	162	19.81	V
10	3600	208-230/460	215JM	N162	215TTWD14002	✓	\$2,163	F3	89.5	27.0-24.0/12.0	165	19.81	V
	1800	208-230/460	215JM	N163	215TTWD14032	✓	\$2,202	F3	89.5	29.0-28.0/14.0	173	19.81	V

Catalog numbers (Cat No.) highlighted in bold blue have efficiency levels that meet EISA requirements

Brakemotor C-Face Footed (Rigid Base)

HP	RPM	VOLTS	FRAME	CAT. NO.	MODEL NO.	STOCK	LIST PRICE	MULT. SYMB.	NOM. EFF.	F.L. AMPS	WEIGHT	BRAKE RATING (Lb/Ft)	"C" DIM.	FOOT NOTES
1/2	1800	208-230/460	56C	N388A	056T17V5354	✓	\$2,769	F3	78.5	1.6-1.6/8	59	3	15.85	N
1	1800	208-230/460	56C	N389A	056T17V5355	✓	\$2,917	F3	81.5	3.1-3.0/1.5	69	6	15.85	N

Continued on next page.

WASHDOWN - Painted and Stainless Steel

PowerWash™ SXT-Plus Washdown Duty, Three Phase

Stainless/BISSC, Totally Enclosed



IEC

B5 Footless

Same features as shown on page 114

HP	RPM	VOLTS	FRAME	CAT. NO.	MODEL NO.	STOCK	LIST PRICE	MULT. SYMB.	NOM. EFF.	F.L. AMPS	WEIGHT	"C" DIM.	FOOT NOTES
1/3 - .25	1800	208-230/460	71	R700	071T17V5326	✓	\$732	F3	70.5	1.3-1.3/.65	30	9.87	N
	1800	208-230/460	80	R701	080T17V5326	✓	\$732	F3	70.5	1.3-1.3/.65	30	9.87	N
1/2 - .37	1800	208-230/460	71	R702	071T17V5327	✓	\$757	F3	76.0	1.9-1.8/0.9	32	11.62	N
	1800	208-230/460	80	R703	080T17V5331	✓	\$757	F3	76.0	1.9-1.8/0.9	32	11.62	N
3/4 - .55	1800	208-230/460	80	R704	080T17W5326	✓	\$802	F3	77.0	2.5-2.4/1.2	38	12.26	V
1 - .75	1800	208-230/460	90L	R705	090LT17W4026	✓	\$853	F3	82.5	3.2-3.1/1.55	45	13.13	V
1 1/2 - 1.1	1800	208-230/460	90L	R706	090LT17W4027	✓	\$900	F3	84.0	4.5-4.4/2.2	49	13.63	V
2 - 1.5	1800	208-230/460	90L	R707	090LT17W4028	✓	\$999	F3	84.0	6.0-5.6/2.8	49	13.63	V

Catalog numbers (Cat No.) highlighted in bold blue have efficiency levels that meet EISA requirements

B5 Footed (Rigid Base)

HP	RPM	VOLTS	FRAME	CAT. NO.	MODEL NO.	STOCK	LIST PRICE	MULT. SYMB.	NOM. EFF.	F.L. AMPS	WEIGHT	"C" DIM.	FOOT NOTES
1/3 - .25	1800	208-230/460	80	R710	080T17V5327	✓	\$744	F3	70.5	1.3-1.3/.65	30	9.50	N
1/2 - .37	1800	208-230/460	80	R711	080T17V5333	✓	\$768	F3	76.0	1.9-1.8/0.9	32	12.75	N
3/4 - .55	1800	208-230/460	80	R712	080T17W5327	✓	\$818	F3	77.0	2.5-2.4/1.2	38	12.75	V

B14 Footless

HP	RPM	VOLTS	FRAME	CAT. NO.	MODEL NO.	STOCK	LIST PRICE	MULT. SYMB.	NOM. EFF.	F.L. AMPS	WEIGHT	"C" DIM.	FOOT NOTES
1/3 - .25	1800	208-230/460	71	R720	071T17V5328	✓	\$732	F3	70.5	1.3-1.3/.65	30	9.83	N
	1800	208-230/460	80	R721	080T17V5328	✓	\$732	F3	70.5	1.3-1.3/.65	30	9.72	N
1/2 - .37	1800	208-230/460	71	R722	071T17V5329	✓	\$757	F3	76.0	1.9-1.8/0.9	32	11.58	N
	1800	208-230/460	80	R723	080T17V5329	✓	\$757	F3	76.0	1.9-1.8/0.9	32	11.58	N
3/4 - .55	1800	208-230/460	80	R724	080T17W5328	✓	\$802	F3	77.0	2.5-2.4/1.2	38	12.48	V

B14 Footed (Rigid Base)

HP	RPM	VOLTS	FRAME	CAT. NO.	MODEL NO.	STOCK	LIST PRICE	MULT. SYMB.	NOM. EFF.	F.L. AMPS	WEIGHT	"C" DIM.	FOOT NOTES
1/3 - .25	1800	208-230/460	80	R730	080T17V5330	✓	\$757	F3	70.5	1.3-1.3/.65	31	9.72	N
1/2 - .37	1800	208-230/460	80	R731	080T17V5332	✓	\$837	F3	76.0	1.9-1.8/0.9	33	11.58	N
3/4 - .55	1800	208-230/460	80	R732	080T17W5329	✓	\$866	F3	77.0	2.5-2.4/1.2	39	12.48	V

PowerWash™ Extreme Washdown Duty, Three Phase

Stainless/BISSC, Totally Enclosed

Features:

- Complete motor Encapsulation
- Suitable for use on VFD 10:1 Variable torque, 10:1 (TEFC) or 1000:1 (TENV) Constant Torque, 1.0 Service Factor
- MAX GUARD® Class F insulation system
- Potted lead entrance
- 1.15 Service Factor on sinewave, 1.0 Service Factor on IGBT power
- Double sealed ball bearings with moisture resistant, high temperature grease
- 300 Series Stainless steel external construction: frame, endshields, shaft, conduit box, mounting base and hardware for superior corrosion resistance
- 100% Paint-free constructions
- Viton® o-rings, shaft seals, and gaskets for superior sealing against chemicals
- Nameplate information laser etched on frame
- BISSC Certified for baking industry
- UL Recognized, CSA Certified and CE Mark



C-Face Footless

Suitable for use on VFD per guidelines on page 17.

HP	RPM	VOLTS	FRAME	CAT. NO.	MODEL NO.	STOCK	LIST PRICE	MULT. SYMB.	NOM. EFF.	F.L. AMPS	WEIGHT	"C" DIM.	FOOT NOTES
1/3	1800	208-230/460	48C	N701	048T17V11001	✓	\$1,183	F3	70.5	1.3-1.3/.65	30	9.58	N
1/2	3600	208-230/460	56C	N703	056T34V99013	✓	\$1,110	F3	82.5	1.7-1.6/.8	38	10.47	N
	1800	208-230/460	48C	N704	048T17V11002	✓	\$1,213	F3	76.0	1.7-1.6/.8	32	11.33	N
	1800	208-230/460	56C	N705	056T17V99016	✓	\$1,287	F3	78.5	1.7-1.6/.8	39	10.72	N
3/4	3600	208-230/460	56C	N707	056T34V99014	✓	\$1,221	F3	84.0	2.6-2.4/1.2	45	10.47	N
	1800	208-230/460	56C	N708	056T17V99011	✓	\$1,317	F3	80.0	2.4-2.3/1.2	46	11.22	N
1	3600	208-230/460	56C	N710	056T34V99011	✓	\$1,296	F3	85.5	2.8-2.6/1.3	47	10.97	N
	1800	208-230/460	56C	N711	056T17V99012	✓	\$1,469	F3	81.5	3.1-3.0/1.5	50	11.69	N
1 1/2	3600	208-230/460	143TC	N713	143TTWD16004	✓	\$1,327	F3	82.5	4.4-4.0/2.0	53	11.75	
	1800	208-230/460	56C	N715	056T17W99007	✓	\$1,534	F3	84.0	4.5-4.4/2.2	55	11.69	
	1800	208-230/460	145TC	N716	143TTWD16033	✓	\$1,746	F3	84.0	4.5-4.4/2.2	55	12.75	
2	3600	208-230/460	145TC	N718	145TTWD16004	✓	\$1,451	F3	84.0	5.6-5.2/2.6	55	12.75	
	1800	208-230/460	56C	N720	056T17W99009	✓	\$1,567	F3	84.0	6.0-5.6/2.8	56	13.25	
	1800	208-230/460	145TC	N721	145TTWD16032	✓	\$1,778	F3	84.0	6.0-5.6/2.8	56	12.69	

C-Face Footed (Rigid Base)

HP	RPM	VOLTS	FRAME	CAT. NO.	MODEL NO.	STOCK	LIST PRICE	MULT. SYMB.	NOM. EFF.	F.L. AMPS	WEIGHT	"C" DIM.	FOOT NOTES
1/2	3600	208-230/460	56C	N753	056T34V99012	✓	\$1,131	F3	82.5	1.7-1.6/.8	39	10.47	N
	1800	208-230/460	56C	N755	056T17V99015	✓	\$1,275	F3	78.5	1.7-1.6/.8	40	10.72	N
3/4	3600	208-230/460	56C	N757	056T34V99015	✓	\$1,242	F3	84.0	2.6-2.4/1.2	46	10.47	N
	1800	208-230/460	56C	N758	056T17V99014	✓	\$1,324	F3	80.0	2.4-2.3/1.15	47	11.22	N
1	3600	208-230/460	56C	N760	056T34V99016	✓	\$1,461	F3	85.5	2.8-2.6/1.3	48	10.37	N
	1800	208-230/460	56C	N761	056T17V99013	✓	\$1,354	F3	81.5	3.1-3.0/1.5	50	11.97	N
1 1/2	3600	208-230/460	143TC	N763	143TTWD16003	✓	\$1,744	F3	84.0	4.4-4.0/2.0	54	11.75	
	1800	208-230/460	56C	N765	056T17W99010	✓	\$1,449	F3	84.0	4.5-4.4/2.2	56	11.69	
	1800	208-230/460	145TC	N766	143TTWD16032	✓	\$1,584	F3	86.5	4.5-4.4/2.2	56	12.75	
2	3600	208-230/460	145TC	N768	145TTWD16005	✓	\$2,596	F3	85.5	5.6-5.2/2.6	56	12.75	
	1800	208-230/460	56C	N770	056T17W99008	✓	\$1,826	F3	84.0	6.0-5.6/2.8	57	12.69	
	1800	208-230/460	145TC	N771	145TTWD16031	✓	\$1,968	F3	86.5	5.6-5.6/2.8	57	13.25	

Catalog numbers (Cat No.) highlighted in bold blue have efficiency levels that meet EISA requirements

Carbonator Pump, Split Phase Drip-proof

Features:

- Resilient base (except as noted)
- Ball bearings
- 1.0 Service Factor (except as noted)
- Completely interchangeable with OEM units
- Automatic reset thermal protector
- UL Recognized and CSA Certified



Single Shaft



Double Shaft

HP	RPM	VOLTS	FRAME	CAT. NO.	MODEL NO.	STOCK	LIST PRICE	MULT. SYMB.	F.L. AMPS	WEIGHT	"C" DIM.	FOOT NOTES
1/4	1800/1500	208-240	48Y	HG451	5KH32GNB813X	✓	\$167	F1	2.3-2.4	14	7.69	68
	1800/1500	115/230	48Z	H344	5KH36KNB633X	✓	\$139	F1	4.3/2.2	16	8.75	
	1800	115	48Y	4725	5KH32DN5587X	✓	\$139	F1	5.0	13	7.69	
	1800	115	48Y	HG679	5KH32DN5597X	✓	\$132	F1	5.0	11	7.69	12,82
1/3	1800/1500	100-120/200-240	48Y	HG681	5KH32GNB814X	✓	\$174	F1	5.5-5.6/2.7-2.8	14	7.69	12,68,82
	1800/1500	100-120/200-240	48Y	H683	5KH33GNA444X	✓	\$196	F1	5.5-5.6/2.7-2.8	14	7.94	
	1800/1500	100-120/200-240	48Y	4805	5KH32GNB811X	✓	\$182	F1	5.5-5.6/2.7-2.8	14	7.69	68
	1800/1500	220-240	48Y	HG450	5KH32GNB812X	✓	\$176	F1	2.7-2.7	14	7.69	68
	1800	115	48Y	4406	5KH32FN5586X	✓	\$152	F1	5.6	14	7.69	18
	1800	115	48Y	HG680	5KH32FN5598X	✓	\$146	F1	5.6	14	7.69	12,18,82
	1800	115	48Y	H682	5KH32ENA443X	✓	\$176	F1	6.1	13	7.69	
1/2	1800	115	48Y	H926	5KH36MNB637X	✓	\$227	F1	7.2	17	8.75	
	1800/1500	100-120/200-240	48Y	H684	5KH36MNA445X	✓	\$227	F1	7.1-7.2/3.4-3.6	17	8.75	68
3/4	1800	115/230	48Y	HG714	5KH37PNA479X	✓	\$302	F1	10.4/5.2	19	9.15	

Double Shaft

HP	RPM	VOLTS	FRAME	CAT. NO.	MODEL NO.	STOCK	LIST PRICE	MULT. SYMB.	F.L. AMPS	WEIGHT	"C" DIM.	FOOT NOTES
1/3	1800/1500	100-120/200-240	48Y	H712	5KH32GNB815X	✓	\$186	F1	5.5-5.6/2.7-2.8	14	9.47	68

Sump Pump, Split Phase Drip-proof

Features:

- Sleeve bearings
- 1.0 Service Factor
- Float switch & cord set
- Completely interchangeable with OEM units
- Automatic reset thermal protector
- UL Recognized and CSA Certified



HP	RPM	VOLTS	FRAME	CAT. NO.	MODEL NO.	STOCK	LIST PRICE	MULT. SYMB.	F.L. AMPS	WEIGHT	"C" DIM.	FOOT NOTES
1/3	1800	115	48K	H641	5KH39CN5501X	✓	\$162	F1	5.7	12	9.6	d,4,15
	1800	115	48K	H642	5KH39CN5504X	✓	\$162	F1	5.7	12	9.6	d,4,16
1/4	1800	115	48K	H950A			\$162	F1	5.0	11	7.9	4,15
1/2	1800	115	48K	H951A			\$212	F1	7.3	17	8.7	4,15

PUMP MOTORS (FLUID HANDLING)

Jet Pump, Two-Compartment Single Phase, Dripproof

Features:

- Two-compartment design for easy servicing
- Not for use in pool pump applications
- 50° C Ambient, as noted
- Fixed CW rotation, viewed opposite shaft end
- UL Recognized and CSA Certified



C-Face Footless, 56C/56J

HP	RPM	VOLTS	FRAME	CAT. NO.	MODEL NO.	STOCK	LIST PRICE	MULT. SYMB.	SERVICE FACTOR	F.L. AMPS	WEIGHT	"C" DIM.	FOOT NOTES
1/3	3600	115	56C	H439	5KH39EN2552X	✓	\$189	F1	1.75	6.2	18	11.03	3,69
	3600	115	56J	H440	5KH39EN2506X	✓	\$192	F1	1.75	6.2	18	11.54	3,69
	3600	115/230	56C	C1081	5KC39EN2553X	✓	\$209	F1	1.75	6.2/3.1	15	11.03	2,69
	3600	115/230	56J	C1087	5KC39EN2500X	✓	\$215	F1	1.75	6.2/3.1	15	11.54	2,69
1/2	3600	115/230	56C	C1082	5KC39HN2554X	✓	\$219	F1	1.6	8.2/4.1	15	11.03	2,69
	3600	115/230	56J	C1088	5KC39HN2501X	✓	\$224	F1	1.6	8.2/4.1	15	11.54	2,69
3/4	3600	115/230	56J	C1089	5KC33MN2502X	✓	\$249	F1	1.5	11.6/5.8	17	12.42	2
	3600	115/230	56J	C1089A	5KC39PN6200X	✓	\$249	F1	1.5	13.0/6.5	17	12.52	2,69
1	3600	115/230	56C	C1084	5KC39SN2810X	✓	\$278	F1	1.4	14.2/7.1	25	13.47	2,69
	3600	115/230	56J	C1090	5KC39SN2812X	✓	\$285	F1	1.4	14.2/7.1	26	13.98	2,69
1 1/2	3600	115/230	56C	C1085	5KCR39SN2557X	✓	\$370	F1	1.3	15.8/7.9	21	13.47	2,69
	3600	115/230	56J	C1091	5KCR39SN2504X	✓	\$377	F1	1.3	15.8/7.9	21	13.98	1,69
2	3600	115/230	56C	C1086	5KCR39UN2558X	✓	\$452	F1	1.2	19.2/9.6	23	13.47	1,69
	3600	115/230	56J	C1092	5KCR39UN2505X	✓	\$458	F1	1.2	19.2/9.6	23	13.98	1,69

C-Face Footled (Rigid Base), 56C/56J

HP	RPM	VOLTS	FRAME	CAT. NO.	MODEL NO.	STOCK	LIST PRICE	MULT. SYMB.	SERVICE FACTOR	F.L. AMPS	WEIGHT	"C" DIM.	FOOT NOTES
1/3	3600	115	56J	H685	5KH39EN2887X	✓	\$200	F1	1.75	6.2	13	11.54	3
1/2	3600	115/230	56J	C1462	5KC39HN2888X	✓	\$230	F1	1.6	8.2/4.1	16	11.54	18
3/4	3600	115/230	56C	C1083	5KC33MN2555X	✓	\$243	F1	1.5	11.6/5.8	17	12.01	82,18
	3600	115/230	56C	C1083A	5KC39PN5105X	✓	\$243	F1	1.5	13.0/6.5	17	13.47	18,69,82
	3600	115/230	56J	C1463	5KC33MN2889X	✓	\$256	F1	1.5	11.6/5.8	19	12.42	2
	3600	115/230	56J	C1463A	5KC39PN6201X	✓	\$256	F1	1.5	13.0/6.5	19	12.52	2,69
1	3600	115/230	56J	C1464	5KC39SN2890X	✓	\$289	F1	1.4	14.2/7.1	26	13.98	2
1.5	3600	115/230	56J	C1465	5KCR39SN2891X	✓	\$382	F1	1.3	15.8/7.9	21	13.98	1
2	3600	115/230	56J	C1466	5KCR39UN2892X	✓	\$463	F1	1.2	19.2/9.6	23	13.98	1

Square Flange

HP	RPM	VOLTS	FRAME	CAT. NO.	MODEL NO.	STOCK	LIST PRICE	MULT. SYMB.	SERVICE FACTOR	F.L. AMPS	WEIGHT	"C" DIM.	FOOT NOTES
1/3	3600	115/230	56Y	C1168	5KC36GN2507X	✓	\$215	F1	1.95	6.4/3.2	15	11.59	2
1/2	3600	115/230	56Y	C1169	5KC36MN2508X	✓	\$216	F1	1.9	10.8/5.4	17	11.59	2
3/4	3600	115/230	56Y	C1170	5KC38PN2509X	✓	\$227	F1	1.65	12.6/6.3	19	12.59	2
1	3600	115/230	56Y	C1171	5KC38SN2510X	✓	\$256	F1	1.65	16.4/8.2	21	12.59	2
1 1/2	3600	230	56Y	C1172	5KCR39UN2511X	✓	\$293	F1	1.5	7.6	23	13.12	1
2	3600	230	56Y	C1173	5KCR39UN2512X	✓	\$390	F1	1.3	8.7	23	13.12	1

Centrifugal Pump (Jet Pump)

Single Phase, Dripproof

Features:

- Service Factor, as noted
- Double sealed ball bearings, mechanically locked on shaft end
- Capacitor start/capacitor run design for higher efficiency, as noted
- Fixed CW rotation, viewed opposite shaft end
- Automatic reset thermal protector
- 56C = carbon steel shaft with key
- 56J = 416 stainless steel threaded shaft with slinger
- Drip cover not included, see Accessories Section
- UL Recognized and CSA Certified



C-Face Footless, 56C/56J

HP	RPM	VOLTS	FRAME	CAT. NO.	MODEL NO.	STOCK	LIST PRICE	MULT. SYMB.	SERVICE FACTOR	F.L. AMPS	WEIGHT	"C" DIM.	FOOT NOTES
1/3	3600	115/230	56C	J1025	5KC37FN71X	✓	\$154	F1	1.75	6.4/3.2	14	10.71	
	3600	115/230	56J	C329	5KC37FN65X	✓	\$162	F1	1.75	6.4/3.2	14	11.22	15
	1800/1500	115/208-230	56J	C683	5KC36LN84X	✓	\$350	F1	1.35	6.0/3.2-3.0	17	10.82	15,50
1/2	3600	115/230	56C	C330	5KC36JN268X	✓	\$169	F1	1.6	7.6/3.8	18	10.31	
	3600	115/230	56J	C331	5KC36JN269X	✓	\$176	F1	1.6	7.6/3.8	18	10.82	15
3/4	3600	115/230	56C	C332	5KC39NN50X	✓	\$199	F1	1.5	11.2/5.6	19	11.84	
	3600	115/230	56J	C333	5KC39QN3219X	✓	\$206	F1	1.5	11.2/5.6	18	12.40	15
	2900	110/220	56C	CG732	5KC39RN114T	✓	\$342	F1	1.5	9.8/4.9	28	12.60	50
1	3600	115/230	56C	C334	5KC39RN44X	✓	\$223	F1	1.4	13.2/6.6	22	12.59	
	3600	115/230	56J	C335	5KC39RN45X	✓	\$229	F1	1.4	13.2/6.6	22	13.14	15
1 1/2	3600	115/208-230	56C	C336	5KC49NN2140X	✓	\$304	F1	1.3	18.4/9.8-9.2	27	11.38	
	3600	115/230	56J	C337	5KC49NN2167X	✓	\$323	F1	1.3	18.4/9.2	26	11.89	
2	3600	115/208-230	56C	C338	5KC49TN2141X	✓	\$377	F1	1.2	21.2/11.5-10.6	38	13.22	
	3600	115/208-230	56J	C339	5KC49TN2170X	✓	\$396	F1	1.2	21.2/10.6	36	13.73	
3	3600	115/230	56C	C340	5KCR48TN2142T	✓	\$699	F1	1.15	29.4/14.7	38	12.66	1
	3600	115/230	56J	C341	5KCR48TN2174T	✓	\$631	F1	1.15	29.4/14.7	38	13.17	1,15

C-Face Footed (Rigid Base), 56J

Additional Features: • Drip cover included

HP	RPM	VOLTS	FRAME	CAT. NO.	MODEL NO.	STOCK	LIST PRICE	MULT. SYMB.	SERVICE FACTOR	F.L. AMPS	WEIGHT	"C" DIM.	FOOT NOTES
1/3	3600	115/208-230	56J	J054	056C34D2118	✓	\$167	F1	1.75	5.6/2.7-2.8	15	10.94	
1/2	3600	115/208-230	56J	J055	056C34D2119	✓	\$181	F1	1.6	7.4/3.5-3.7	17	11.19	
3/4	3600	115/208-230	56J	J056	056C34D2120	✓	\$211	F1	1.5	9.8/4.8-4.9	20	11.44	
1	3600	115/208-230	56J	J057	056C34D2121	✓	\$234	F1	1.4	12.0/6.2-6.0	23	12.44	
1 1/2	3600	115/208-230	56J	J058	056B34D2033	✓	\$327	F1	1.3	13.4/7.4-6.7	23	12.43	1
2	3600	115/208-230	56J	J059	056B34D5341	✓	\$402	F1	1.2	18.2/9.8-9.1	33	11.94	1

Single Phase, Totally Enclosed

Features:

- Service Factor, as noted
- Double sealed ball bearings, mechanically locked on shaft end
- Capacitor start/capacitor run design for higher efficiency, as noted
- Reversible CW rotation, viewed opposite shaft end
- Automatic reset thermal protector
- 56C = carbon steel shaft with key
- 56J = 416 stainless steel threaded shaft with slinger
- Drip cover not included
- UL Recognized and CSA Certified



C-Face Footless, 56C/56J

HP	RPM	VOLTS	FRAME	CAT. NO.	MODEL NO.	STOCK	LIST PRICE	MULT. SYMB.	SERVICE FACTOR	F.L. AMPS	WEIGHT	"C" DIM.	FOOT NOTES
1/3	3600	115/230	56J	C1336	5KC33FN4180X	✓	\$282	F1	1.0	5.6/2.8	14	11.87	
1/2	3600	115/230	56J	C465	5KC39QN3218X	✓	\$350	F1	1.15	7.4/3.7	19	11.9	15
3/4	3600	115/230	56C	C847	5KC37NN115X	✓	\$373	F1	1.0	9.8/4.9	22	11.76	
1	3600	115/230	56J	C352	5KC49NN2135X	✓	\$402	F1	1.15	13.0/6.5	27	12.95	15
2	3600	115/230	56J	C878	5KCR49TN2164T	✓	\$604	F1	1.0	17.8/8.9	38	14.79	ES,1,15

PUMP MOTORS (FLUID HANDLING)

Centrifugal Pump (Jet Pump)

Three Phase, Dripproof

Features:

- Service Factor, as noted
- Double sealed ball bearings, mechanically locked on shaft end
- Continuous Duty
- Nameplated 60/50 hertz, 190/380 volts at next lower HP, as noted
- 56C = carbon steel shaft with key
- 56J = 416 stainless steel threaded shaft with slinger
- UL Recognized and CSA Certified
- Drip cover not included, see Accessories section



C-Face Footless, 56C/56J

HP	RPM	VOLTS	FRAME	CAT. NO.	MODEL NO.	STOCK	LIST PRICE	MULT. SYMB.	SERVICE FACTOR	F.L. AMPS	WEIGHT	"C" DIM.	FOOT NOTES
1/3	3600	208-230/460	56C	KG215	5K35FN55	✓	\$177	F1	1.75	1.5-1.8/0.9	14	9.90	68
	3600	208-230/460	56J	K748	5K35FN101	✓	\$178	F1	1.75	1.5-1.8/0.9	14	10.40	48
1/2	3600	208-230/460	56C	K216	5K36JN57	✓	\$201	F1	1.6	2.0-2.0/1.0	16	10.31	48,68
	3600	208-230/460	56J	K217	5K36JN56	✓	\$202	F1	1.6	2.0-2.0/1.0	16	10.82	48,68
	1800	208-230/460	56J	K553	5K42HN4139	✓	\$397	F1	1.25	2.3-2.2/1.1	18	10.41	48
3/4	3600	208-230/460	56C	K218	5K37MN37	✓	\$242	F1	1.5	2.6-2.6/1.3	18	10.70	48,68
	3600	208-230/460	56J	KG219	5K37MN38	✓	\$243	F1	1.5	2.6-2.6/1.3	17	11.22	48,68,d
	3600	208-230/460	56J	K1483	5K37MN3543	✓	\$247	F1	1.50	2.6-2.6/1.3	17	11.22	48
1	1800	208-230/460	56J	K555	5K46KN4141	✓	\$467	F1	1.25	3.3-3.0/1.5	24	11.24	48
	3600	208-230/460	56C	K220	5K38PN47	✓	\$275	F1	1.4	3.3-3.2/1.6	19	11.30	48,68
	3600	208-230/460	56J	K221	5K38PN48	✓	\$276	F1	1.4	3.3-3.2/1.6	19	11.82	48,68
1 1/2	1800	208-230/460	56J	K750	5K46MN4144	✓	\$483	F1	1.15	3.6-3.8/1.9	27	11.24	48
	3600	208-230/460	56C	K222	5K46KN2173	✓	\$335	F1	1.3	5.0-4.8/2.4	24	10.73	48,68
	3600	208-230/460	56J	K223	5K46KN2172	✓	\$336	F1	1.3	5.0-4.8/2.4	23	11.24	48,68
	3600	208-230/460	56J	K1484	5K46KN2082	✓	\$341	F1	1.15	5.0-4.8/2.4	24	11.24	48
2	1800	208-230/460	56J	K751	5K49PN4121	✓	\$533	F1	1.15	5.8-5.6/2.8	28	11.84	48
	3600	208-230/460	56C	K224	5K49NN2180	✓	\$392	F1	1.2	6.0-6.0/3.0	27	11.33	48,68
	3600	208-230/460	56J	K225	5K49NN2178	✓	\$392	F1	1.2	6.0-6.0/3.0	27	11.84	48,68
3	3600	208-230/460	56C	K226	5K48TN2182	✓	\$440	F1	1.15	8.9-8.2/4.1	38	12.61	48,68
	3600	208-230/460	56J	K227	5K48TN2181	✓	\$443	F1	1.15	8.9-8.2/4.1	38	13.12	48,68

Additional Features:

- Drip cover is included



C-Face Footed (Rigid Base), 56J

C-Face Footed (Rigid Base)

HP	RPM	VOLTS	FRAME	CAT. NO.	MODEL NO.	STOCK	LIST PRICE	MULT. SYMB.	SERVICE FACTOR	F.L. AMPS	WEIGHT	"C" DIM.	FOOT NOTES
1/3	3600	208-230/460	56J	J047	056T34D5368		\$183	F1	1.75	1.2-1.1/1.55	21	10.43	68
1/2	3600	208-230/460	56J	J048	056T34D5367	✓	\$206	F1	1.6	2.1-2.2/1.1	21	10.93	68
3/4	3600	208-230/460	56J	J049	056T34D5365	✓	\$247	F1	1.5	2.6-2.6/1.3	22	11.22	68
1	3600	208-230/460	56J	J050	056T34D5366	✓	\$281	F1	1.4	3.7-3.7/1.85	23	10.93	68
1 1/2	3600	208-230/460	56J	J051	056T34D5369	✓	\$341	F1	1.15	5.0-4.8/2.4	23	11.24	68
2	3600	208-230/460	56J	J052	056T34D5370	✓	\$399	F1	1.2	6.4-6.2/3.1	30	10.93	68
3	3600	208-230/460	56J	J053	056T34D5371	✓	\$447	F1	1.15	8.9-8.4/4.2	32	11.93	68

Centrifugal Pump (Jet Pump)

Three Phase, Totally Enclosed

Features:

- Service Factor, as noted
- Double sealed ball bearings, mechanically locked on shaft end
- Continuous Duty
- Nameplated 60/50 hertz, 190/380 volts at next lower HP, as noted
- 56C = carbon steel shaft with key
- 56J = 416 stainless steel threaded shaft with slinger
- UL Recognized, CSA Certified, and CE Mark
- Drip cover not included, see Accessories Section



C-Face Footless, 56C/56J

HP	RPM	VOLTS	FRAME	CAT. NO.	MODEL NO.	STOCK	LIST PRICE	MULT. SYMB.	SERVICE FACTOR	F.L. AMPS	WEIGHT	"C" DIM.	FOOT NOTES
1/3	3600	208-230/460	56C	P101	056T34T5306	✓	\$205	F1	1.35	1.7-2.0/1.0	18	9.94	N,68
1/2	3600	208-230/460	56C	P102	056T34F5321	✓	\$228	F1	1.15	2.1-2.2/1.1	21	11.82	12,18
	3600	200-230/460	56J	K230	5K35JN47	✓	\$331	F1	1.6	2.1-2.0/1.0	17	11.40	18,82
	1800	208-230/460	56J	K550	5K42HN4133	✓	\$402	F1	1.0	2.3-2.2/1.1	22	11.52	48
3/4	3600	208-230/460	56C	P103	056T34F5322	✓	\$270	F1	1.15	3.0-3.2/1.6	22	11.82	68
	3600	208-230/460	56J	KG232	5K36MN339	✓	\$366	F1	1.5	2.6-2.6/1.3	16	11.90	48,d
1	3600	208-230/460	56C	P104	056T34F5323	✓	\$303	F1	1.15	3.7-3.7/1.85	24	11.82	68
	3600	200-230/460	56J	KG234	5K38RN49	✓	\$420	F1	1.4	3.2-3.0/1.5	25	12.90	48,d
1 1/2	3600	208-230/460	56C	P105	056T34F5324	✓	\$352	F1	1.15	4.6/2.3	25	11.82	68
	3600	200-230/460	56J	KG236	5K49PN2330	✓	\$452	F1	1.3	4.8-4.2/2.1	31	12.95	48
2	3600	208-230/460	56C	P106	056T34F5325	✓	\$408	F1	1.15	6.0-6.0/3.0	29	12.32	68
	3600	200-230/460	56J	K238	5K49SN2184	✓	\$513	F1	1.2	5.8-5.4/2.7	35	13.48	48
3	3600	208-230/460	56C	P107	056T34F5326	✓	\$443	F1	1.15	8.4-7.6/3.8	38	13.32	68
	3600	230/460	56J	K240	5K49ZN2190	✓	\$621	F1	1.0	8.0/4.0	49	14.79	48

Additional Features:

- Drip cover included



C-Face Footed (Removable Base), 56J

HP	RPM	VOLTS	FRAME	CAT. NO.	MODEL NO.	STOCK	LIST PRICE	MULT. SYMB.	SERVICE FACTOR	F.L. AMPS	WEIGHT	"C" DIM.	FOOT NOTES
1/3	3600	208-230/460	56J	J060	056T34T5308		\$225	F1	1.15	1.7-2.0/1.0	21	10.44	N,68
1/2	3600	208-230/460	56J	J061	056T34F5342	✓	\$247	F1	1.15	2.1-2.2/1.1	23	12.32	68
3/4	3600	208-230/460	56J	J062	056T34F5343	✓	\$290	F1	1.15	3.0-3.2/1.6	23	12.32	68
1	3600	208-230/460	56J	J063	056T34F5344	✓	\$323	F1	1.15	3.7-3.7/1.85	25	12.32	68
1 1/2	3600	208-230/460	56J	J064	056T34F5345	✓	\$388	F1	1.15	4.7-4.6/2.3	26	12.32	68
2	3600	208-230/460	56J	J065	056T34F5346	✓	\$445	F1	1.15	6.0-6.0/3.0	30	12.82	68
3	3600	208-230/460	56J	J066	056T34F5347	✓	\$507	F1	1.15	8.4-7.6/3.8	40	13.82	68

PUMP MOTORS (FLUID HANDLING)

Close-Coupled Pump, JM

Single Phase, Dripproof

Applications:

Close-coupled pumps where the pump impeller is mounted directly on the motor shaft in environments that are relatively clean and dry.

Features:

- NEMA JM pump shaft dimensions
- Ball bearings, mechanically locked on shaft end
- Capacitor start design for high starting torque
- Capacitor start / capacitor run design for higher efficiency, as noted
- Continuous duty
- 1.15 Service Factor
- UL Recognized and CSA Certified



C-Face Footed (Rigid Base)

HP	RPM	VOLTS	FRAME	CAT. NO.	MODEL NO.	STOCK	LIST PRICE	MULT. SYMB.	NOM. EFF.	F.L. AMPS	WEIGHT	"C" DIM.	FOOT NOTES
1	1800	115/208-230	143JM	Z401	143TCDR5328		\$427	S2	72.0	13.4/6.8-6.7	34	13.62	68
1 1/2	1800	115/208-230	145JM	Z403	145TCDR5328		\$475	S2	77.0	18.0/9.3-9.0	43	14.62	68
2	3600	115/208-230	145JM	Z404	145TBDR5304		\$478	S2	78.5	19.2/10.5-9.6	36	13.62	1
	1800	115/230	182JM	Z405A	182TCDW7074	✓	\$545	S2	72.0	23.0/11.5	69	16.09	13
3	3600	115/230	182JM	Z406A	182TCDW7318	✓	\$605	S2	75.5	32.0/16.1	60	15.32	13
	1800	115/230	184JM	Z407A	184TCDR7047	✓	\$707	S2	75.5	33.0/16.5	77	17.59	13
5	3600	230	184JM	Z408A	184TBDW17007	✓	\$886	S2	80.0	22.0	93	16.32	1,13
	1800	230	213JM	Z409	213TCDW7027	✓	\$972	S2	78.5	28.0	115	19.92	
7 1/2	3600	230	213JM	Z410	213TCDW7002	✓	\$1,106	S2	78.5	37.0	106	18.42	
	1800	230	215JM	Z411	215TBDW7029	✓	\$1,343	S2	84.0	34.5	120	19.92	1
10	3600	230	215JM	Z412	215TCDW7002	✓	\$1,423	S2	81.5	47.0	150	19.92	
	1800	230	215JM	Z413	215TBDW7027	✓	\$1,628	S2	82.5	44.0	159	21.17	1

Close-Coupled Pump, JM

Single Phase, Totally Enclosed

Applications:

Close-coupled pumps where the pump impeller is mounted directly on the motor shaft in damp, dusty, or dirty environments.

Features:

- NEMA JM pump shaft dimensions
- Ball bearings, mechanically locked on shaft end
- Capacitor start/capacitor run design for higher efficiency
- Continuous duty
- 1.0 Service Factor (except as noted)
- UL Recognized and CSA Certified



C-Face Footed (Rigid Base)

HP	RPM	VOLTS	FRAME	CAT. NO.	MODEL NO.	STOCK	LIST PRICE	MULT. SYMB.	NOM. EFF.	F.L. AMPS	WEIGHT	"C" DIM.	FOOT NOTES
5	3600	230	184JM	Z433A	184TBFW7315	✓	\$917	S2	82.5	19.2	89	18.59	13
7 1/2	3600	230	213JM	Z434	213TBFW7010	✓	\$1,231	S2	81.5	32.0	90	20.59	68
10	3600	230	215JM	Z435	215TBFW7010	✓	\$1,500	S2	85.5	41.5	236	22.09	18

Close-Coupled Pump, JM, Three Phase

Dripproof, C-Face Footless (Vertical) and C-Face Footed (Rigid Base)

Features:

- NEMA JM pump shaft dimensions
- JMV frame includes drip cover for vertical mount without base
- JM frame has rigid base, drip cover not included
- Ball bearings, mechanically locked on shaft end
- Continuous duty
- 1.15 Service Factor
- UL Recognized and CSA Certified
- UL Listed for Fire Pump applications (except as noted)



Suitable for use on VFD per guidelines on page 17.

HP	RPM	VOLTS	FRAME	CAT. NO.	MODEL NO.	STOCK	LIST PRICE	MULT. SYMB.	NOM. EFF.	F.L. AMPS	WEIGHT	"C" DIM.	FOOT NOTES
1	1800	200	143JM	E115	143TTDR4040		\$354	S2	82.5	3.6	41	14.62	
	1800	200	143JMV	E117	143TTDR4041		\$395	S2	82.5	3.6	40	14.92	27
	1800	230/460	143JM	E100	143TTDR4035	✓	\$354	S2	82.5	3.1/1.55	44	14.62	68
	1800	230/460	143JMV	E118	143TTDR4034	✓	\$395	S2	82.5	3.1/1.55	40	14.92	27,68
	1800	575	143JM	E116	143TTDR4047		\$354	S2	82.5	1.1	36	14.62	
	1800	575	143JMV	E119	143TTDR4046		\$395	S2	82.5	1.1	40	14.92	27
1 1/2	3600	200	143JM	E120	143TTDR4016		\$404	S2	82.5	5.5	32	13.12	1,13
	3600	200	143JMV	E122	143TTDR4017		\$445	S2	82.5	5.5	32	12.92	27
	3600	230/460	143JM	E123	143TTDR4009	✓	\$404	S2	82.5	4.8/2.4	28	13.12	68
	3600	208-230/460	143JMV	E095	143TTDR14004		\$445	S2	82.5	5.2-5.0/2.5	42	12.92	27,68
	3600	575	143JM	E121	143TTDR4022		\$404	S2	82.5	1.9	28	13.12	
	3600	575	143JMV	E124	143TTDR4024		\$445	S2	82.5	1.9	36	12.92	27
	1800	200	145JM	E125	145TTDR4040		\$386	S2	84.0	5.0	41	14.62	
	1800	200	145JMV	E127	145TTDR4041		\$429	S2	84.0	5.0	39	14.92	27
	1800	230/460	145JM	E102	145TTDR4034	✓	\$386	S2	84.0	4.4/2.2	44	14.62	68
	1800	230/460	145JMV	E128	145TTDR4035	✓	\$429	S2	84.0	4.4/2.2	39	14.92	27,68
	1800	575	145JM	E126	145TTDR4072		\$386	S2	84.0	1.8	41	14.62	
	1800	575	145JMV	E129	145TTDR4047		\$429	S2	84.0	1.8	40	14.92	27
2	3600	200	145JM	E130	145TTDR4015		\$454	S2	84.0	6.2	43	13.12	
	3600	200	145JMV	E132	145TTDR4016		\$496	S2	84.0	6.2	32	13.42	27
	3600	208-230/460	145JM	E096	145TTDR4317	✓	\$454	S2	84.0	5.6-5.4/2.7	33	13.12	68
	3600	230/460	145JMV	E133	145TTDR4010	✓	\$496	S2	84.0	5.4/2.7	44	13.42	27,68,d
	3600	575	145JM	E131	145TTDR4021		\$454	S2	84.0	2.2	32	13.12	
	3600	575	145JMV	E134	145TTDR4022		\$496	S2	84.0	2.2	32	13.42	27
	1800	200	145JM	E135	145TTDR4066		\$404	S2	84.0	6.7	45	15.12	
	1800	200	145JMV	E137	145TTDR4067		\$445	S2	84.0	6.7	42	15.42	27
	1800	230/460	145JM	E104	145TTDR4060	✓	\$404	S2	84.0	5.8/2.9	48	15.12	68
	1800	230/460	145JMV	E138	145TTDR4051	✓	\$445	S2	84.0	5.8/2.9	44	15.42	27,68
	1800	575	145JM	E136	145TTDR4046		\$404	S2	84.0	2.3	45	15.12	
	1800	575	145JMV	E139	145TTDR4073		\$445	S2	84.0	2.3	43	15.42	27
3	3600	200	145JM	E140	145TTDR4115		\$507	S2	84.0	10	34	13.62	
	3600	200	145JMV	E142	145TTDR4307		\$549	S2	84.0	10	34	13.92	27
	3600	208-230/460	145JM	M311	145TTDR5315	✓	\$406	S2	84.0	8.9-8.4/4.2	34	13.62	68
	3600	208-230/460	145JMV	M312	145TTDR5316	✓	\$448	S2	84.0	8.9-8.4/4.2	33	13.92	27,68
	3600	230/460	145JM	E105	145TTDR4303		\$507	S2	84.0	8.4/4.2	26	13.62	68
	3600	230/460	145JMV	E143	145TTDR4110		\$549	S2	84.0	8.4/4.2	34	13.92	27,68
	3600	575	145JM	E141	145TTDR4121		\$507	S2	84.0	3.5	34	13.62	
	3600	575	145JMV	E144	145TTDR4025		\$549	S2	84.0	3.5	33	13.92	27

Catalog numbers (Cat No.) highlighted in bold blue have efficiency levels that meet EISA requirements

Continued on next page.

Close-Coupled Pump, JM, Three Phase

DripProof, C-Face Footless (Vertical) and C-Face Footed (Rigid Base)

HP	RPM	VOLTS	FRAME	CAT. NO.	MODEL NO.	STOCK	LIST PRICE	MULT. SYMB.	NOM. EFF.	F.L. AMPS	WEIGHT	"C" DIM.	FOOT NOTES
3	1800	200	182JM	E145	182TTDR4140		\$471	S2	86.5	9.4	70	17.09	
	1800	200	182JMV	E147	182TTDR4036		\$555	S2	86.5	9.9	78	18.87	27
	1800	208-230/460	182JM	E097	182TTDW14029	✓	\$471	S2	86.5	8.8/4.4	83	14.82	13,68,98
	1800	230/460	182JM	E106A	182TTDW4336	✓	\$471	S2	86.5	9.0-8.8/4.4	70	14.82	13,68
	1800	230/460	182JMV	E098	182TTDW4006	✓	\$555	S2	85.5	9.0-8.8/4.4	64	18.78	27,68,98
	1800	230/460	182JMV	E148A	182TTDW4135	✓	\$555	S2	86.5	8.8/4.4	64	18.78	27,68
	1800	575	182JM	E146	182TTDR4146		\$471	S2	86.5	3.45	89	16.09	
5	1800	575	182JMV	E149A	182TTDW4147		\$555	S2	86.5	3.5	87	18.28	27
	3600	200	182JM	E150A	182TTDW4116		\$608	S2	85.5	14.3	65	14.82	13
	3600	200	182JMV	E152	182TTDR4117		\$690	S2	86.5	13.8	78	16.68	27
	3600	208-230/460	182JM	M1315	182TTDB7325		\$528	S2	85.5	13.6-12.4/6.2	88	14.82	13,68,98
	3600	208-230/460	182JMV	M1316	182TTDB7601		\$590	S2	85.5	13.6-12.4/6.2	74	19.24	27,68,98
	3600	230/460	182JM	E107A	182TTDW4325	✓	\$608	S2	85.5	14-12.4/6.2	87	14.82	13
	3600	230/460	182JMV	E153A	182TTDW4304	✓	\$690	S2	85.5	12.4/6.2	78	18.78	27
	3600	575	182JM	E151	182TTDR4122		\$608	S2	86.5	4.8	79	16.09	13
	3600	575	182JMV	E154	182TTDR4123		\$690	S2	86.5	4.8	73	16.68	27
	1800	200	184JM	E155	184TTDR4140		\$608	S2	87.5	15.1	78	16.59	
7 1/2	1800	200	184JMV	E157	184TTDR4141		\$690	S2	87.5	14.5	78	19.37	27
	1800	208-230/460	184JM	M1317	184TTDW7357	✓	\$608	S2	87.5	14.6-13.2/6.6	78	14.82	68,98
	1800	230/460	184JM	E108	184TTDR4034		\$608	S2	87.5	13.2/6.6	75	17.09	13
	1800	230/460	184JMV	E158A	184TTDW4135	✓	\$690	S2	87.5	13.2/6.6	78	15.72	27,68
	1800	575	184JM	E156	184TTDR4146		\$608	S2	87.5	5.3	89	17.59	13
	1800	575	184JMV	E159	184TTDR4147		\$690	S2	87.5	5.2	83	19.37	27
	3600	200	184JM	E160	184TTDR4115		\$731	S2	87.5	20.2	87	17.09	13
	3600	200	184JMV	E162	184TTDR4116		\$815	S2	87.5	20.2	89	19.87	27
	3600	230/460	184JM	E109A	184TTDW14001	✓	\$731	S2	87.5	17.6/8.8	89	15.82	13,68,98
	3600	230/460	184JMV	E163A	184TTDW4005	✓	\$815	S2	87.5	17.6/8.8	90	15.82	27,68,98
10	3600	575	184JM	E161	184TTDR4121		\$731	S2	87.5	7.2	90	17.09	13
	3600	575	184JMV	E164	184TTDR4122		\$815	S2	87.5	7.2	98	17.68	27
	1800	200	213JM	E165	213TTDW4042		\$686	S2	88.5	22.1	118	19.16	
	1800	200	213JMV	E167	213TTDW4033		\$772	S2	88.5	22.1	96	20.44	27
	1800	230/460	213JM	E110	213TTDW4047	✓	\$879	S2	88.5	19.2/9.6	100	19.16	68
	1800	230/460	213JMV	E168	213TTDW4048	✓	\$772	S2	88.5	19.2/9.6	121	20.44	27,68
	1800	575	213JM	E166	213TTDW4041		\$686	S2	88.5	7.6	120	19.16	
	1800	575	213JMV	E169	213TTDW4038		\$990	S2	88.5	7.7	142	20.44	27
	3600	200	213JM	E170	213TTDW4009		\$940	S2	88.5	26.9	131	19.16	
	3600	200	213JMV	E172	213TTDW4008		\$1,049	S2	88.5	26.9	112	20.44	27
15	3600	230/460	213JM	E111	213TTDW4022	✓	\$940	S2	88.5	23.4/11.7	135	19.16	68
	3600	230/460	213JMV	E173	213TTDW4023	✓	\$1,049	S2	88.5	23.4/11.7	132	20.44	27
	3600	575	213JM	E171	213TTDW4010		\$940	S2	88.5	9.3	153	19.16	
	3600	575	213JMV	E174	213TTDW4007		\$1,049	S2	88.5	9.3	125	20.44	27
	1800	200	215JM	E175	215TTDW4041		\$1,043	S2	89.5	28.7	124	19.16	68,98
	1800	200	215JMV	E177	215TTDW4043		\$1,152	S2	89.5	28.7	128	20.44	27,68
	1800	230/460	215JM	E112	215TTDW4047	✓	\$1,043	S2	89.5	25.0/12.5	135	19.16	68
	1800	230/460	215JMV	E178	215TTDW4048	✓	\$1,152	S2	89.5	25.0/12.5	135	20.44	27
	1800	575	215JM	E176	215TTDW4042		\$1,043	S2	89.5	10.0	125	19.16	13
	1800	575	215JMV	E179	215TTDW4032		\$1,152	S2	89.5	10.0	118	20.44	27
15	3600	200	215JM	E180	215TTDW4008		\$1,161	S2	90.2	39.0	128	20.41	13
	3600	200	215JMV	E182	215TTDW4010		\$1,272	S2	90.2	39.0	160	21.69	27

PUMP MOTORS (FLUID HANDLING)

Catalog numbers (Cat No.) highlighted in bold blue have efficiency levels that meet EISA requirements

Continued on next page.

Close-Coupled Pump, JM, Three Phase

Dripproof, C-Face Footless (Vertical) and C-Face Footed (Rigid Base)

HP	RPM	VOLTS	FRAME	CAT. NO.	MODEL NO.	STOCK	LIST PRICE	MULT. SYMB.	NOM. EFF.	F.L. AMPS	WEIGHT	"C" DIM.	FOOT NOTES
15	3600	230/460	215JM	E113	215TTDW4022	✓	\$1,161	S2	90.2	34.0/17.0	131	20.41	13
	3600	230/460	215JMV	E183	215TTDW4023	✓	\$1,272	S2	90.2	34.0/17.0	127	21.69	27,68
	3600	575	215JM	E181	215TTDW4009		\$1,161	S2	90.2	13.6	159	20.41	13
	3600	575	215JMV	E184	215TTDW4007		\$1,272	S2	90.2	13.6	127	21.69	27
	1800	200	254JM	E185	254TTDX4343		\$1,410	S2	91.0	44.0	268	24.17	13
	1800	200	254JMV	E187	254TTDX4345		\$1,571	S2	91.0	44.2	263	25.45	27
	1800	208-230/460	254JM	E114A	254TTDX14062	✓	\$1,410	S2	91.0	115/208-230	248	24.17	68
	1800	230/460	254JMV	E188	254TTDX4039	✓	\$1,571	S2	91.0	38.5/19.2	220	25.45	27,68
	1800	575	254JM	E186	254TTDX4344		\$1,043	S2	91.0	15.3	200	24.17	27
	20	3600	200	254JM	E190	254TTDX4007		\$1,161	S2	91.0	53.1	204	24.17
	3600	200	254JMV	E193	254TTDX4015		\$1,625	S2	91.0	53.1	185	23.70	27
	3600	230/460	254JM	E191	254TTDX4006	✓	\$1,465	S2	91.0	46.0/23.1	213	22.42	
	3600	230/460	254JMV	E194	254TTDX4020		\$1,625	S2	91.0	46.0/23.1	187	23.70	27,68
	3600	575	254JM	E192	254TTDX4019		\$1,465	S2	91.0	18.5	225	22.42	
	3600	575	254JMV	E195	254TTDX4024		\$1,625	S2	91.0	18.5	178	23.70	27
	1800	200	256JMV	E199	256TTDX4329		\$1,860	S2	91.0	60.0	235	25.45	27
	1800	230/460	256JM	E197	256TTDX4075	✓	\$1,702	S2	91.0	52.0/26	128	24.17	68
	1800	230/460	256JMV	U100	256TTDX4041		\$1,860	S2	91.0	50.0/25	196	25.45	27,68
	1800	575	256JM	E198	256TTDX4326		\$1,702	S2	91.0	20.8	238	24.17	
	1800	575	256JMV	U101	256TTDX4047		\$1,860	S2	91.0	20.8	188	25.45	27
25	3600	200	256JM	U102	256TTDX4021		\$1,723	S2	91.0	66.5	225	24.17	
	3600	230/460	256JM	U103	256TTDX4006	✓	\$1,723	S2	91.0	58.0/29	126	24.17	68
	3600	575	256JM	U104	256TTDX4019		\$1,723	S2	91.0	23.2	196	24.17	
	1800	208	284JM	U105	284TTDP4043		\$2,058	S2	91.7	67.5	358	24.31	
	1800	230/460	284JM	U106	284TTDP4069	✓	\$2,058	S2	91.7	61.0/30.5	360	24.31	68
	1800	575	284JM	U107	284TTDP4037		\$2,058	S2	91.0	24.5	360	24.31	68
30	3600	200	284JM	U108	284TTDP4025		\$2,101	S2	91.0	83.0	295	24.31	
	3600	230/460	284JM	U109A	284TTDP14009	✓	\$2,101	S2	91.0	72./36.0	346	24.31	
	3600	575	284JM	U110	284TTDP4023		\$2,101	S2	91.0	28.8	315	24.31	
	1800	200	286JM	U111	286TTDP4067		\$2,377	S2	92.4	83.0	410	25.81	
	1800	230/460	286JM	U112	286TTDP4037		\$2,377	S2	92.4	72.0/36.0	385	25.81	68
	1800	575	286JM	U113	286TTDP4047		\$2,377	S2	92.4	28.8	385	25.81	d,68
40	3600	230/460	286JM	U114	286TTDP4015	✓	\$2,629	S2	91.7	94.0/47.0	575	25.81	
	3600	575	286JM	U115	286TTDP4021		\$2,629	S2	91.7	38.0	386	25.81	
	1800	230/460	324JM	U116	324TTDP4345		\$3,106	S2	93.0	97.0/48.5	340	26.25	68
50	3600	230/460	324JM	U118	324TTDP4004	✓	\$3,364	S2	92.4	117/58.5	460	26.25	
	3600	575	324JM	U119	324TTDP4018		\$3,364	S2	92.4	47.0	460	26.25	
	1800	230/460	326JM	U120	326TTDP4329		\$3,587	S2	93.0	123/61.5	525	27.75	68
	1800	575	326JM	U121	326TTDP4326		\$3,587	S2	93.0	47.5	525	27.75	

Catalog numbers (Cat No.) highlighted in bold blue have efficiency levels that meet EISA requirements

Blue shaded areas are Cast Iron Frames

PUMP MOTORS (FLUID HANDLING)

Globetrotter® NEMA Premium® Efficiency Close Coupled Pump, JM, Three Phase

Dripproof, C-Face Footed (Rigid Base)

Features:

☛ Meets or exceeds NEMA Premium® efficiencies

NEMA Premium® models are in compliance with EISA2007

- Inverter Duty 10:1 Variable Torque and 2:1 Constant Torque, 1.0 SF
- Nameplated 60/50 hertz, 190/380 volts at next lower HP
- 1.15 Service Factor
- Class F Insulation
- Standard assembly F1, reversible to F2 assembly
- UL Recognized, CSA Certified, CE Mark
- Three year warranty



Suitable for use on VFD per guidelines on page 17.

HP	RPM	VOLTS	FRAME	CAT. NO.	MODEL NO.	STOCK	LIST PRICE	MULT. SYMB.	NOM. EFF.	F.L. AMPS	WEIGHT	"C" DIM.	FOOT NOTES	
1	1800	200	143JM	GT2001	143TTDR16043	✓	\$415	S2	85.5	3.8	41	14.62		
	1800	200	143JMV	GT4001	143TTDR16042	✓	\$415	S2	85.5	3.8	41	14.62		
	1800	208-230/460	143JM	GT0401	143TTDR6030	✓	\$415	S2	85.5	2.5-3.2/1.6	41	14.62		
	1800	208-230/460	143JMV	GT4101	143TTDR16047	✓	\$415	S2	85.5	3.2/1.6	41	14.62		
	1800	575	143JM	GT0501	143TTDR6031	✓	\$415	S2	85.5	1.2	41	14.62		
	1800	575	143JMV	GT4201	143TTDR16039	✓	\$415	S2	85.5	1.2	41	14.62		
	1200	208-230/460	145JM	GT0402		✓	\$685	S2	82.5	3.8-4.4/2.2	41	14.62		
	1200	575	145JM	GT0502		✓	\$685	S2	82.5	1.8	41	14.62		
1 1/2	3600	200	143JM	GT2003	143TTDR16009	✓	\$474	S2	84.0	4.4	40	13.12		
	3600	200	143JMV	GT4003	143TTDR16012	✓	\$474	S2	84.0	4.4	40	13.12		
	3600	208-230/460	143JM	GT0403	143TTDR6007	✓	\$474	S2	84.0	4.4-4.0/2.0	40	13.12		
	3600	208-230/460	143JMV	GT4103	143TTDR16013	✓	\$474	S2	84.0	4.0/2.0	40	13.12		
	3600	575	143JM	GT0503	143TTDR6008	✓	\$474	S2	84.0	1.7	40	13.12		
	3600	575	143JMV	GT4203	143TTDR16007	✓	\$474	S2	84.0	1.7	40	13.12		
	1800	200	145JM	GT2004	145TTDR16074	✓	\$452	S2	86.5	5.6	44	14.62		
	1800	200	145JMV	GT4004	145TTDR16073	✓	\$452	S2	86.5	5.6	44	14.62		
	1800	208-230/460	145JM	GT0404	145TTDR6034	✓	\$452	S2	86.5	4.8-5.6/2.4	44	14.62		
	1800	208-230/460	145JMV	GT4104	145TTDR16329	✓	\$452	S2	86.5	4.8/2.4	44	14.62		
	1800	575	145JM	GT0504	145TTDR6031	✓	\$452	S2	86.5	1.8	44	14.62		
	1800	575	143JMV	GT4204	143TTDR16046	✓	\$452	S2	86.5	1.8	44	14.62		
	1200	208-230/460	182JM	GT0405	182TTDB6082	✓	\$778	S2	86.5	4.4/2.2	101	16.34		
	1200	575	182JM	GT0505	182TTDB6092	✓	\$778	S2	86.5	1.8	101	16.34		
	2	3600	200	145JM	GT2006	145TTDR16015	✓	\$532	S2	85.5	5.2	43	13.12	
		3600	200	145JMV	GT4006	145TTDR16013	✓	\$532	S2	85.5	5.2	43	13.12	
3600		208-230/460	145JM	GT0406	145TTDR6007	✓	\$532	S2	85.5	5.2-4.8/2.4	43	13.12		
3600		208-230/460	145JMV	GT4106	145TTDR16019	✓	\$532	S2	85.5	4.8/2.4	43	13.12		
3600		575	145JM	GT0506	145TTDR6004	✓	\$532	S2	85.5	2.0	43	13.12		
3600		575	145JMV	GT4206	145TTDR16018	✓	\$532	S2	85.5	2.0	43	13.12		
1800		200	145JM	GT2007	145TTDR16335	✓	\$512	S2	86.5	6.0	45	15.12		
1800		200	145JMV	GT4007	145TTDR16336	✓	\$512	S2	86.5	6.0	45	15.12		
3600		208-230/460	145JM	GT0506	145TTDR6004	✓	\$532	S2	85.5	2.0	43	13.12		
1800		208-230/460	145JMV	GT4107	145TTDR16332	✓	\$512	S2	86.5	5.8/2.9	45	15.12		
1800		575	145JM	GT0507	145TTDR6030	✓	\$512	S2	86.5	2.5	45	15.12		
1800		575	145JMV	GT4207	145TTDR16338	✓	\$512	S2	86.5	2.5	45	15.12		
1200		208-230/460	184JM	GT0408	184TTDB6082	✓	\$790	S	87.5	5.8/2.9	110	17.37		
1200		575	184JM	GT0508	184TTDB6092	✓	\$790	S	87.5	2.3	110	17.37		

PUMP MOTORS (FLUID HANDLING)

Catalog numbers (Cat No.) highlighted in bold blue have efficiency levels that meet EISA requirements

Continued on next page.

Globetrotter® NEMA Premium® Efficiency, Close Coupled Pump, JM, Three Phase

Dripproof, C-Face Footed (Rigid Base)

HP	RPM	VOLTS	FRAME	CAT. NO.	MODEL NO.	STOCK	LIST PRICE	MULT. SYMB.	NOM. EFF.	F.L. AMPS	WEIGHT	"C" DIM.	FOOT NOTES
3	3600	200	145JM	GT2009	145TTDR16023	✓	\$595	S2	86.5	8.0	47	13.62	
	3600	200	145JMV	GT4009	145TTDR16022	✓	\$595	S2	86.5	8.0	47	13.62	
	3600	208-230/460	145JM	GT0409	145TTDR6013	✓	\$595	S2	86.5	8.0-7.2/3.6	47	13.62	
	3600	208-230/460	145JMV	GT4109	145TTDR16305	✓	\$595	S2	86.5	7.2/3.6	47	13.62	
	3600	575	145JM	GT0509	145TTDR6006	✓	\$595	S2	86.5	2.8	47	13.62	
	3600	575	145JMV	GT4209	145TTDR16302	✓	\$595	S2	86.5	2.8	47	13.62	
	1800	208-230/460	182JM	GT0410	182TTDB6032	✓	\$566	S2	89.5	8.4-7.8/3.9	123	15.35	
	1800	575	182JM	GT0510	182TTDB6033	✓	\$566	S2	89.5	3.1	123	15.35	
	1200	230/460	213JM	GT0411	213TTDB6082	✓	\$1,087	S2	88.5	9.2-8.8/4.4	156	19.22	
	1200	575	213JM	GT0511	213TTDB6092	✓	\$1,087	S2	88.5	3.5	156	19.22	
5	3600	208-230/460	182JM	GT0412	182TTDB6007	✓	\$715	S2	86.5	13.2-11.8/5.9	131	15.35	
	3600	575	182JM	GT0512	182TTDB6008	✓	\$715	S2	86.5	4.7	131	15.35	
	1800	208-230/460	184JM	GT0413	184TTDB6032	✓	\$687	S2	89.5	13.6-12.4/6.2	135	16.34	
	1800	575	184JM	GT0513	184TTDB6033	✓	\$687	S2	89.5	5.0	135	16.34	
	1200	230/460	215JM	GT0414	215TTDB6082	✓	\$1,265	S2	89.5	15.2-14.0/7.0	281	19.22	
	1200	575	215JM	GT0514	215TTDB6092	✓	\$1,265	S2	89.5	5.6	281	19.22	
7 1/2	3600	208-230/460	184JM	GT0415	184TTDB6007	✓	\$858	S2	88.5	19.0-17.2/8.6	149	16.34	A
	3600	575	184JM	GT0515	184TTDB6008	✓	\$858	S2	88.5	6.9	149	16.34	
	1800	230/460	213JM	GT0416	213TTDB6032	✓	\$1,047	S2	91.0	20.4-18.6/9.3	166	17.68	
	1800	575	213JM	GT0516	213TTDB6033	✓	\$1,047	S2	91.0	7.5	166	17.68	
	1200	208-230/460	254JM	GT0417	254TTDCA6082	✓	\$1,582	S2	90.2	22.0-21.0/10.5	281	24.41	
	1200	575	254JM	GT0517	254TTDCA6092	✓	\$1,582	S2	90.2	8.4	281	24.41	
10	3600	208-230/460	213JM	GT0418	213TTDB6007	✓	\$1,106	S2	89.5	25.5-23/11.5	156	17.68	
	3600	575	213JM	GT0518	213TTDB6008	✓	\$1,106	S2	89.5	9.2	156	17.68	
	1800	230/460	215JM	GT0419	215TTDB6032	✓	\$1,225	S2	91.7	26.9-24.4/12.2	229	19.17	
	1800	575	215JM	GT0519	215TTDB6033	✓	\$1,225	S2	91.7	9.8	229	19.17	
	1200	208-230/460	256JM	GT0420	256TTDCA6082	✓	\$1,972	S2	91.7	29.6-27.6/13.8	305	25.99	
	1200	575	256JM	GT0520	256TTDCA6092	✓	\$1,972	S2	91.7	11.0	305	25.99	
15	3600	208-230/460	215JM	GT0421	215TTDB6007	✓	\$1,366	S2	90.2	38.0-34.0/17.0	191	19.17	
	3600	575	215JM	GT0521	215TTDB6008	✓	\$1,366	S2	90.2	13.6	191	19.17	
	1800	208-230/460	254JM	GT0422	254TTDCA6032	✓	\$1,646	S2	93.0	38.0/19.0	322	24.41	
	1800	575	254JM	GT0522	254TTDCA6033	✓	\$1,646	S2	93.0	15.2	322	24.41	
	1200	208-230/460	284JM	GT0423	284TTDCA6082	✓	\$2,597	S2	91.7	42.5-40.0/20.0	414	26.58	
	1200	575	284JM	GT0523	284TTDCA6092	✓	\$2,597	S2	91.7	16.0	414	26.58	
20	3600	208-230/460	254JM	GT0424	254TTDCA6007	✓	\$1,705	S2	91.0	51.0-46.0/23.0	312	24.41	
	3600	575	254JM	GT0524	254TTDCA6008	✓	\$1,705	S2	91.0	18.4	312	24.41	
	1800	208-230/460	256JM	GT0425	256TTDCA6032	✓	\$2,021	S2	93.0	53.0-49.0/24.5	374	26.00	
	1800	575	256JM	GT0525	256TTDCA6033	✓	\$2,021	S2	93.0	19.6	374	26.00	
	1200	208-230/460	286JM	GT0426	286TTDCA6082	✓	\$3,165	S2	92.4	58.0-54.0/27.0	457	27.09	
	1200	575	286JM	GT0526	286TTDCA6092	✓	\$3,165	S2	92.4	21.6	457	27.09	
25	3600	208-230/460	256JM	GT0427	256TTDCA6007	✓	\$2,062	S2	91.7	64.0-57.0/28.5	328	26.00	
	3600	575	256JM	GT0527	256TTDCA6008	✓	\$2,062	S2	91.7	22.8	328	26.00	
	1800	208-230/460	284JM	GT0428	284TTDCA6032	✓	\$2,412	S2	93.6	66.0-62.0/31.0	441	26.58	
	1800	575	284JM	GT0528	284TTDCA6033	✓	\$2,412	S2	93.6	24.8	441	26.58	
	1200	208-230/460	324JM	GT0429	324TTDCA6082	✓	\$3,770	S2	93.0	72.0-68.0/34.0	695	28.94	
	1200	575	324JM	GT0529	324TTDCA6092	✓	\$3,770	S2	93.0	27.2	695	28.94	

PUMP MOTORS (FLUID HANDLING)

Catalog numbers (Cat No.) highlighted in bold blue have efficiency levels that meet EISA requirements

Blue shaded areas are Cast Iron Frames

Continued on next page

Globetrotter® NEMA Premium® Efficiency, Close Coupled Pump, JM, Three Phase

Dripproof, C-Face Footed (Rigid Base)

HP	RPM	VOLTS	FRAME	CAT. NO.	MODEL NO.	STOCK	LIST PRICE	MULT. SYMB.	NOM. EFF.	F.L. AMPS	WEIGHT	"C" DIM.	FOOT NOTES
30	3600	208-230/460	284JM	GT0430	284TTDCA6007	✓	\$2,462	S2	91.7	76.0-68.0/34.0	412	26.58	
	3600	575	284JM	GT0530	284TTDCA6008	✓	\$2,462	S2	91.7	27.2	412	26.58	
	1800	208-230/460	286JM	GT0431	286TTDCA6032	✓	\$2,786	S2	94.1	81.0-74.0/37.0	502	27.10	
	1800	575	286JM	GT0531	286TTDCA6033	✓	\$2,786	S2	94.1	29.6	502	27.10	
	1200	208-230/460	326JM	GT0432	326TTDCA6082	✓	\$4,416	S2	93.6	83.5-78.5/39.0	760	30.12	
	1200	575	326JM	GT0532	326TTDCA6092	✓	\$4,415	S2	93.6	32.5	760	30.12	
40	3600	208-230/460	286JM	GT0433	286TTDCA6007	✓	\$3,082	S2	92.4	100-90.0/45.0	470	27.10	
	3600	575	286JM	GT0533	286TTDCA6008	✓	\$3,082	S2	92.4	36.0	470	27.10	
	1800	208-230/460	324JM	GT0434	324TTDCA6032	✓	\$3,640	S2	94.1	105-95.0/47.5	604	28.95	
	1800	575	324JM	GT0534	324TTDCA6033	✓	\$3,640	S2	94.1	40.4	604	28.95	
50	3600	208-230/460	324JM	GT0436	324TTDCA6007	✓	\$3,943	S2	93.0	124-113/56.5	570	28.95	
	3600	575	324JM	GT0536	324TTDCA6008	✓	\$3,943	S2	93.0	45.0	570	28.95	
	1800	208-230/460	326JM	GT0437	326TTDCA6032	✓	\$4,205	S2	94.5	131-118/59.0	738	30.12	
	1800	575	326JM	GT0537	326TTDCA6033	✓	\$4,205	S2	94.5	47.0	738	30.12	

Catalog numbers (Cat No.) highlighted in bold blue have efficiency levels that meet EISA requirements

Blue shaded areas are Cast Iron Frames

Close-Coupled Pump, JM Three Phase, Totally Enclosed

Features:

- NEMA JM pump shaft dimensions
- Ball bearings, mechanically locked on shaft end
- Continuous duty
- 1.15 Service Factor (except as noted)
- UL Recognized and CSA Certified



C- Face Footed (Rigid Base)

Suitable for use on VFD per guidelines on page 17.

HP	RPM	VOLTS	FRAME	CAT. NO.	MODEL NO.	STOCK	LIST PRICE	MULT. SYMB.	NOM. EFF.	F.L. AMPS	WEIGHT	"C" DIM.	FOOT NOTES
1	1800	200	143JM	U300	143TTFR4040		\$439	S2	82.5	3.5	35	15.00	
	1800	230/460	143JM	U301	143TTFR4034	✓	\$439	S2	82.5	3.0/1.5	35	15.00	
	1800	575	143JM	U302	143TTFR4046		\$439	S2	82.5	1.2	35	15.00	
1 1/2	3600	200	143JM	U303	143TTFR4015		\$516	S2	82.5	4.6	31	15.00	
	3600	208-230/460	143JM	U304A	143TTFR4303	✓	\$516	S2	82.5	4.4-4.0/2.0	31	14.50	68
	3600	575	143JM	U305	143TTFR4021		\$516	S2	82.5	1.6	31	15.00	
	1800	200	145JM	U306	145TTFR4048		\$481	S2	84.0	5.1	45	16.50	
2	1800	230/460	145JM	U307	145TTFR4045	✓	\$481	S2	84.0	4.4/2.2	46	16.50	68
	1800	575	145JM	U308	145TTFR4054		\$481	S2	84.0	1.8	45	16.50	
	3600	200	145JM	U309	145TTFR4017		\$559	S2	84.0	6.0	39	15.50	
	3600	208-230/460	145JM	U310A	145TTFR14011	✓	\$559	S2	84.0	5.6-5.2/2.6	39	15.50	
	3600	575	145JM	U311	145TTFR4023		\$559	S2	84.0	2.1	39	15.50	
	1800	200	145JM	U312	145TTFR4050		\$503	S2	84.0	6.4	48	16.00	
2	1800	208-230/460	145JM	U313A	145TTFR14045	✓	\$503	S2	84.0	6.6-6.2/3.1	48	16.00	
	1800	575	145JM	U314	145TTFR4128		\$503	S2	84.0	2.2	48	16.00	

Catalog numbers (Cat No.) highlighted in bold blue have efficiency levels that meet EISA requirements

Continued on next page.

Close-Coupled Pump, JM

Three Phase, Totally Enclosed

C- Face Footed (Rigid Base)

HP	RPM	VOLTS	FRAME	CAT. NO.	MODEL NO.	STOCK	LIST PRICE	MULT. SYMB.	NOM. EFF.	F.L. AMPS	WEIGHT	"C" DIM.	FOOT NOTES
3	3600	208-230/460	145JM	U363	145TTFR4310	✓	\$590	S2	85.5	8.4-8.0/4.0	59	15.00	68,d
	3600	200	182JM	U315	182TTFR4015		\$641	S2	85.5	8.5	81	17.35	
	3600	230/460	182JM	U316A	182TTFW4302	✓	\$641	S2	85.5	8.2-7.4/3.7	89	17.35	13
	3600	575	182JM	U317	182TTFR4021		\$641	S2	85.5	2.95	81	17.35	
	1800	208-230/460	182JM	U319A	182TTFW4330	✓	\$586	S2	87.5	8-8.6/4.3	72	16.59	13
	1800	575	182JM	U320	182TTFR4056		\$586	S2	87.5	3.35	79	18.35	
5	3600	230/460	184JM	U322A	184TTFW4009	✓	\$761	S2	87.5	12.2/6.1	118	16.09	13
	3600	575	184JM	U323	184TTFR4021		\$761	S2	87.5	4.9	82	18.35	
	1800	208-230/460	184JM	U325A	184TTFW4760	✓	\$708	S2	87.5	14.0-13.0/6.5	82	15.59	13
	1800	575	184JM	U326A	184TTFW14028		\$761	S2	87.5	5.2	89	15.59	13
7 1/2	3600	200	213JM	U327	213TTFW4009		\$949	S2	88.5	21.1	125	22.09	
	3600	208-230/460	184JM	U360	184TTFW4915	✓	\$718	S2	88.5	17.6-16.8/8.4	127	18.09	13,17,68
	3600	230/460	213JM	U329	213TTFW4022	✓	\$949	S2	88.5	18.4/9.2	113	22.09	68
	3600	575	213JM	U331	213TTFW4010		\$949	S2	88.5	7.3	147	22.09	68
	1800	230/460	213JM	U334	213TTFW4047	✓	\$1,085	S2	89.5	20.0/10.0	131	20.59	68
	1800	575	213JM	U335	213TTFW4038		\$1,085	S2	89.5	8	225	20.59	68
10	3600	200	215JM	U336	215TTFW4014		\$1,161	S2	89.5	27.6	128	22.09	
	3600	230/460	215JM	U337	215TTFW4022	✓	\$1,161	S2	89.5	24.0/12.0	142	22.09	68
	3600	575	215JM	U338	215TTFW4015		\$1,161	S2	89.5	9.6	158	22.09	
	1800	200	215JM	U339	215TTFW4035		\$1,298	S2	89.5	29.9	130	22.09	
	1800	230/460	215JM	U340	215TTFW4047	✓	\$1,298	S2	89.5	25.6/12.8	135	22.09	
	1800	575	215JM	U341	215TTFW4036		\$1,298	S2	89.5	10.4	128	22.09	
15	3600	208-230/460	215JM	U357	215TTFW14301	✓	\$1,182	S2	90.2	39.0-36.0/18.0	151	22.09	68
	3600	230/460	254JM	U344	254TTFL4006	✓	\$1,451	S2	91.0	35.0/17.5	138	24.74	AL,68
	3600	575	254JM	U346	254TTFL4010		\$1,451	S2	90.2	14.0	563	24.74	AL
	1800	200	254JM	U347	254TTFL4034		\$1,760	S2	91.0	46.0	225	24.74	AL
	1800	230/460	254JM	U348	254TTFL4031	✓	\$1,760	S2	91.0	40.0/20.0	224	24.74	AL,68
	1800	575	254JM	U349	254TTFL4036		\$1,760	S2	91.0	16.0	220	24.74	AL
20	3600	200	256JM	U350	256TTFL4010		\$1,953	S2	90.2	54.1	232	26.49	AL
	3600	230/460	256JM	U351	256TTFL4006	✓	\$1,953	S2	90.2	47.0/23.5	232	26.49	AL,68
	3600	575	256JM	U352	256TTFL4012		\$1,953	S2	90.2	18.8	232	26.49	AL
	1800	200	256JM	U353	256TTFL4036		\$2,136	S2	91.0	58.7	321	28.49	AL
	1800	230/460	256JM	U354	256TTFL4031	✓	\$2,136	S2	91.0	51.0/25.5	321	28.49	AL,68
	1800	575	256JM	U355	256TTFL4038		\$2,136	S2	91.0	20.4	321	28.49	AL

PUMP MOTORS (FLUID HANDLING)

Close-Coupled Pump, JP

Single Phase, Dripproof

Features:

- NEMA JP pump shaft dimensions
- Ball bearings, mechanically locked on shaft end
- Capacitor start design for high starting torque
- Capacitor start / capacitor run design for higher efficiency, as noted
- Continuous duty
- 1.15 Service Factor
- UL Recognized and CSA Certified



C-Face Footed (Rigid Base)

HP	RPM	VOLTS	FRAME	CAT. NO.	MODEL NO.	STOCK	LIST PRICE	MULT. SYMB.	NOM. EFF.	F.L. AMPS	WEIGHT	"C" DIM.	FOOT NOTES
1	1800	115/208-230	143JP	Z420	143TCDR5330		\$395	S2	72.0	13.4/6.8-6.7	35	16.68	95
1 1/2	1800	115/208-230	145JP	Z422	145TCDR5329		\$475	S2	77.0	18.6/9.9-9.3	43	17.68	95
2	1800	115/230	182JP	Z424	182TCDR7354		\$605	S2	72.0	23.0/11.5	78	19.15	13
3	3600	115/230	182JP	Z425	182TCDR8005		\$605	S2	74.0	32.0/16.0	87	18.65	13
	1800	115/230	184JP	Z426	184TCDR7626		\$707	S2	75.5	33.0/16.5	94	20.65	13
5	3600	230	184JP	Z427A	184TBDW17011	√	\$886	S2	80.0	22.0	89	19.46	1,13
	1800	230	213JP	Z428	213TCDW7028		\$972	S2	78.5	28.0	130	23.79	95
7 1/2	3600	230	213JP	Z429	213TCDW7003	√	\$1,106	S2	78.5	37.0	118	22.29	95
	1800	230	215JP	Z430	215TBDW7045		\$1,343	S2	84.0	34.5	132	23.79	1,95
10	3600	230	215JP	Z431	215TCDW7004	√	\$1,423	S2	81.5	47.0	135	23.79	95
	1800	230	215JP	Z432	215TBDW7030		\$1,628	S2	82.5	44.0	325	25.04	1,95

Globetrotter® NEMA Premium® Efficiency Close-Coupled Pump, JM, Three Phase

TEFC, C-Face Footed (Rigid Base)

Features:

- Meets or exceeds NEMA Premium® efficiencies NEMA Premium® models are in compliance with EISA2007
- Inverter Duty 10:1 Variable Torque and 2:1 Constant Torque, 1.0 SF
- Dual rated motors are nameplated 60/50 hertz, 190/380 volts at next lower HP
- 1.15 Service Factor
- Class F Insulation
- Standard assembly F1, reversible to F2 assembly
- UL Recognized, CSA Certified, CE Mark
- Three year warranty



Suitable for use on VFD per guidelines on page 17.

HP	RPM	VOLTS	FRAME	CAT. NO.	MODEL NUMBER	STOCK	LIST PRICE	MULT. SYMB.	NOM. EFF.	F.L. AMPS	WEIGHT	"C" DIM.	FOOT NOTES
1	1800	200	143JM	GT3001	143TTFR16047	√	\$536	S2	85.5	3.8	59	16.00	
	1800	200	143JMV	GT5001	143TTFR16048	√	\$529	S2	85.5	3.8	57	16.79	
1800	208-230/460	143JM	GT3101	143TTFR16032	√	\$536	S2	85.5	3.3/1.65	59	16.00		
	208-230/460	143JMV	GT5101	143TTFR16052	√	\$529	S2	85.5	3.3/1.65	57	16.79		
1800	575	143JM	GT3201	143TTFR16046	√	\$536	S2	85.5	1.3	59	16.00		
	575	143JMV	GT5201	143TTFR16042	√	\$529	S2	85.5	1.3	57	16.79		
1200	208-230/460	145JM	GT3102		√	\$824	S2	82.5	3.8/1.9	59	16.79		
	575	145JM	GT3202		√	\$824	S2	82.5	1.5	59	16.79		

Catalog numbers (Cat No.) highlighted in bold blue have efficiency levels that meet EISA requirements

Continued on next page.

Globetrotter® NEMA Premium® Efficiency Close-Coupled Pump, JM, Three Phase TEFC, C-Face Footed (Rigid Base)

HP	RPM	VOLTS	FRAME	CAT. NO.	MODEL NUMBER	STOCK	LIST PRICE	MULT. SYMB.	NOM. EFF.	F.L. AMPS	WEIGHT	"C" DIM.	FOOT NOTES
1 1/2	3600	200	143JM	GT3003	143TTFR16007	✓	\$630	S2	84.0	4.6	63	15.50	
	3600	200	143JMV	GT5003	143TTFR16005	✓	\$622	S2	84.0	4.6	61	16.29	
	3600	208-230/460	143JM	GT3103	143TTFR16010	✓	\$630	S2	84.0	4.0/2.0	63	15.50	
	3600	208-230/460	143JMV	GT5103	143TTFR16006	✓	\$622	S2	84.0	4.0/2.0	61	16.29	
	3600	575	143JM	GT3203	143TTFR16013	✓	\$630	S2	84.0	1.6	63	15.50	
	3600	575	143JMV	GT5203	143TTFR16004	✓	\$622	S2	84.0	1.6	61	16.29	
	1800	200	145JM	GT3004	145TTFR16059	✓	\$587	S2	86.5	5.3	68	16.50	
	1800	200	145JMV	GT5004	145TTFR16058	✓	\$580	S2	86.5	5.3	66	17.29	
	1800	208-230/460	145JM	GT3104	145TTFR16036	✓	\$587	S2	86.5	4.6/2.3	68	16.50	
	1800	208-230/460	145JMV	GT5104	145TTFR16074	✓	\$580	S2	86.5	4.6/2.3	66	17.29	
	1800	575	145JM	GT3204	145TTFR16063	✓	\$587	S2	86.5	2.0	68	16.50	
	1800	575	145JMV	GT5204	145TTFR16062	✓	\$580	S2	86.5	2.0	66	17.29	
	1200	230/460	182JM	GT3105	182TTFB6082	✓	\$903	S2	87.5	4.6/2.3	108	17.51	
	1200	575	182JM	GT3205	182TTFB6092	✓	\$903	S2	87.5	1.9	108	17.51	
2	3600	200	145JM	GT3006	145TTFR16010	✓	\$682	S2	85.5	5.8	71	16.50	
	3600	200	145JMV	GT5006	145TTFR16009	✓	\$674	S2	85.5	5.8	69	17.29	
	3600	208-230/460	145JM	GT3106	145TTFR16013	✓	\$682	S2	85.5	5.2/2.6	71	16.50	
	3600	208-230/460	145JMV	GT5106	145TTFR16012	✓	\$674	S2	85.5	5.2/2.6	69	17.29	
	3600	575	145JM	GT3206	145TTFR16018	✓	\$682	S2	85.5	2.0	71	16.50	
	3600	575	145JMV	GT5206	145TTFR16017	✓	\$674	S2	85.5	2.0	69	17.29	
	1800	200	145JM	GT3007	145TTFR16067	✓	\$614	S2	86.5	7.6	76	17.00	
	1800	200	145JMV	GT5007	145TTFR16066	✓	\$606	S2	86.5	7.6	74	17.79	
	1800	208-230/460	145JM	GT3107	145TTFR16037	✓	\$614	S2	86.5	6.0/3.0	76	17.00	
	1800	208-230/460	145JMV	GT5107	145TTFR16057	✓	\$606	S2	86.5	6.0/3.0	74	17.79	
	1800	575	145JM	GT3207	145TTFR16071	✓	\$614	S2	86.5	2.4	76	17.00	
	1800	575	145JMV	GT5207	145TTFR16070	✓	\$606	S2	86.5	2.4	74	17.79	
	1200	208-230/460	184JM	GT3108	184TTFB6082	✓	\$944	S2	88.5	6.0/3.0	117	18.36	
	1200	575	184JM	GT3208	184TTFB6092	✓	\$944	S2	88.5	2.4	117	18.36	
3	3600	208-230/460	182JM	GT3109	182TTFB6006	✓	\$782	S2	86.5	7.6/3.8	83	17.51	
	3600	575	182JM	GT3209	182TTFB6008	✓	\$782	S2	86.5	3.1	83	17.51	
	1800	208-230/460	182JM	GT3110	182TTFB6031	✓	\$715	S2	89.5	7.8/3.9	87	17.51	
	1800	575	182JM	GT3210	182TTFB6033	✓	\$715	S2	89.5	3.1	87	17.51	
	1200	208-230/460	213JM	GT3111	213TTFB6082	✓	\$1,100	S2	89.5	8.6/4.3	164	20.65	
	1200	575	213JM	GT3211	213TTFB6092	✓	\$1,100	S2	89.5	3.5	164	20.65	
5	3600	208-230/460	184JM	GT3112	184TTFB6006	✓	\$928	S2	88.5	12.0/6.0	95	18.36	
	3600	575	184JM	GT3212	184TTFB6008	✓	\$928	S2	88.5	4.8	95	18.36	
	1800	208-230/460	184JM	GT3113	184TTFB6031	✓	\$864	S2	89.5	12.4/6.2	110	18.36	
	1800	575	184JM	GT3213	184TTFB6033	✓	\$864	S2	89.5	5.0	110	18.36	
	1200	208-230/460	215JM	GT3114	215TTFB6082	✓	\$1,329	S2	89.5	14.0/7.0	174	22.14	
	1200	575	215JM	GT3214	215TTFB6092	✓	\$1,329	S2	89.5	5.6	174	22.14	
7 1/2	3600	208-230/460	213JM	GT3115	213TTFB6006	✓	\$1,158	S2	88.5	12.0/6.0	116	20.65	
	3600	575	213JM	GT3215	213TTFB6008	✓	\$1,158	S2	88.5	4.8	116	20.65	
	1800	230/460	213JM	GT3116	213TTFB6031	✓	\$1,324	S2	89.5	12.4/6.2	143	20.65	
	1800	575	213JM	GT3216	213TTFB6033	✓	\$1,324	S2	89.5	5.0	143	20.65	
	1200	208-230/460	254JM	GT3117	254TTFCA6082	✓	\$2,298	S2	91.0	21.0/10.5	315	26.60	
	1200	575	254JM	GT3217	254TTFCA6092	✓	\$2,298	S2	91.0	8.4	315	26.60	
10	3600	208-230/460	215JM	GT3118	215TTFB6006	✓	\$1,416	S2	90.2	22.8/11.4	137	22.14	
	3600	575	215JM	GT3218	215TTFB6008	✓	\$1,416	S2	90.2	9.1	137	22.14	
	1800	230/460	215JM	GT3119	215TTFB6031	✓	\$1,584	S2	91.7	24.4/12.2	164	22.14	
	1800	575	215JM	GT3219	215TTFB6033	✓	\$1,584	S2	91.7	9.8	164	22.14	
	1200	208-230/460	256JM	GT3120	256TTFCA6082	✓	\$2,807	S2	91.0	28.0/14.0	345	27.80	
	1200	575	256JM	GT3220	256TTFCA6092	✓	\$2,807	S2	91.0	11.2	345	27.80	

PUMP MOTORS (FLUID HANDLING)

Globetrotter® NEMA Premium® Efficiency Close-Coupled Pump, JM, Three Phase

TEFC, C-Face Footed (Rigid Base)

HP	RPM	VOLTS	FRAME	CAT. NO.	MODEL NUMBER	STOCK	LIST PRICE	MULT. SYMB.	NOM. EFF.	F.L. AMPS	WEIGHT	"C" DIM.	FOOT NOTES
15	3600	208-230/460	254JM	GT3121	254TTFCA6006	✓	\$1,770	S2	91.0	34/17.0	350	26.60	
	3600	575	254JM	GT3221	254TTFCA6008	✓	\$1,770	S2	91.0	13.6	350	26.60	
	1800	208-230/460	254JM	GT3122	254TTFCA6031	✓	\$2,147	S2	92.4	37/18.5	375	26.60	
	1800	575	254JM	GT3222	254TTFCA6033	✓	\$2,147	S2	92.4	14.8	375	26.60	
	1200	208-230/460	284JM	GT3123	284TTFCA6082	✓	\$3,726	S2	91.7	41.0/20.5	475	30.92	
	1200	575	284JM	GT3223	284TTFCA6092	✓	\$3,726	S2	91.7	15.9	475	30.92	
20	3600	208-230/460	256JM	GT3124	256TTFCA6006	✓	\$2,087	S2	91.0	46.0/23.0	375	27.80	
	3600	575	256JM	GT3224	256TTFCA6008	✓	\$2,087	S2	91.0	18.4	375	27.80	
	1800	208-230/460	256JM	GT3125	256TTFCA6031	✓	\$2,437	S2	93.0	48.0/24.0	425	27.80	
	1800	575	256JM	GT3225	256TTFCA6033	✓	\$2,437	S2	93.0	19.6	425	27.80	
	1200	208-230/460	286JM	GT3126	286TTFCA6082	✓	\$4,540	S2	91.7	52.0/26.0	550	32.10	
	1200	575	286JM	GT3226	286TTFCA6092	✓	\$4,540	S2	91.7	20.8	550	32.10	
25	3600	208-230/460	284JM	GT3127	284TTFCA6006	✓	\$2,383	S2	91.7	55.5/27.7	475	30.92	
	3600	575	284JM	GT3227	284TTFCA6008	✓	\$2,383	S2	91.7	22.4	475	30.92	
	1800	208-230/460	284JM	GT3128	284TTFCA6032	✓	\$2,606	S2	93.6	62.0/31.0	500	30.92	
	1800	575	284JM	GT3228	284TTFCA6033	✓	\$2,606	S2	93.6	24.4	500	30.92	
	1200	208-230/460	324JM	GT3129	324TTFCA6082	✓	\$5,503	S2	93.0	67.0/33.5	675	32.93	
	1200	575	324JM	GT3229	324TTFCA6092	✓	\$5,503	S2	93.0	26.8	675	32.93	
30	3600	208-230/460	286JM	GT3130	286TTFCA6006	✓	\$2,492	S2	91.7	66.0/33.0	500	32.10	
	3600	575	286JM	GT3230	286TTFCA6008	✓	\$2,492	S2	91.7	27.2	500	32.10	
	1800	208-230/460	286JM	GT3131	286TTFCA6032	✓	\$2,816	S2	93.6	73.0/36.5	525	32.10	
	1800	575	286JM	GT3231	286TTFCA6033	✓	\$2,816	S2	93.6	29.2	252	32.10	
	1200	208-230/460	326JM	GT3132	326TTFCA6082	✓	\$6,337	S2	93.0	80.0/40.0	725	34.11	
	1200	575	326JM	GT3232	326TTFCA6092	✓	\$6,337	S2	93.0	32	725	34.11	
40	3600	208-230/460	324JM	GT3133	324TTFCA6007	✓	\$3,122	S2	92.4	88.0/44.0	675	32.93	
	3600	575	324JM	GT3233	324TTFCA6008	✓	\$3,122	S2	92.4	35.0	675	32.93	
	1800	208-230/460	324JM	GT3134	324TTFCA6031	✓	\$3,680	S2	94.1	94.0/47.0	750	32.93	
	1800	575	324JM	GT3234	324TTFCA6033	✓	\$3,680	S2	94.1	37.5	750	32.93	
50	3600	208-230/460	326JM	GT3136	326TTFCA6007	✓	\$3,993	S2	93.0	109/54.5	725	34.11	
	3600	575	326JM	GT3236	326TTFCA6008	✓	\$3,993	S2	93.0	43.5	725	34.11	
	1800	208-230/460	326JM	GT3137	326TTFCA6031	✓	\$4,255	S2	94.5	119/59.5	775	34.11	
	1800	575	326JM	GT3237	326TTFCA6033	✓	\$4,255	S2	94.5	47.5	775	34.11	

Catalog numbers (Cat No.) highlighted in bold blue have efficiency levels that meet EISA requirements

Blue shaded areas are Cast Iron Frames

Close-Coupled Pump, JP, Three Phase

Drip-proof, C-Face Footless (Vertical) and C-Face Footed (Rigid Base)

Features:

- NEMA JP pump shaft dimensions
- JPV frame includes drip cover for vertical mount without base
- JP frame has rigid base, drip cover not included
- Ball bearings, mechanically locked on shaft end
- Continuous duty
- 1.15 Service Factor
- UL Recognized and CSA Certified
- UL Listed for Fire Pump applications (except as noted)



Suitable for use on VFD per guidelines on page 17.

HP	RPM	VOLTS	FRAME	CAT. NO.	MODEL NO.	STOCK	LIST PRICE	MULT. SYMB.	NOM. EFF.	F.L. AMPS	WEIGHT	"C" DIM.	FOOT NOTES	
1	1800	200	143JP	U122	143TTDR4042		\$354	S2	82.5	3.6	41	17.68		
	1800	200	143JPV	U125	143TTDR4043		\$395	S2	82.5	3.6	41	17.98	27	
	1800	208-230/460	143JP	U123A	143TTDR14048		\$354	S2	82.5	3.3-3.1/1.6	41	17.68	68	
	1800	230/460	143JPV	U126	143TTDR4037		\$395	S2	82.5	3.1/1.6	41	17.98	68	
	1800	575	143JP	U124	143TTDR4048		\$354	S2	82.5	1.1	42	17.68		
	1800	575	143JPV	U127	143TTDR4049		\$395	S2	82.5	1.1	42	17.98	27	
	1 1/2	3600	200	143JP	U128	143TTDR4018		\$404	S2	82.5	5.5	46	16.18	95
3600		200	143JPV	U131	143TTDR4019		\$445	S2	82.5	5.5	45	15.98	27	
3600		208-230/460	143JP	U129A	143TTDR4003	√	\$404	S2	82.5	4.9-5.0/2.5	46	16.18	68,d	
3600		230/460	143JPV	U132	143TTDR4011		\$445	S2	82.5	4.8/2.4	46	15.98	27	
3600		575	143JP	U130	143TTDR4023		\$404	S2	82.5	1.9	47	16.18	1,95	
3600		575	143JPV	U133	143TTDR4025		\$445	S2	82.5	1.9	47	15.98	27	
1800		200	145JP	U134	145TTDR4042		\$386	S2	84.0	5.0	47	17.68		
1800		200	145JPV	U137	145TTDR4043		\$429	S2	84.0	5.0	47	17.98	27	
1800		208-230/460	145JP	U135A	145TTDR4354	√	\$386	S2	84.0	4.6-4.4/2.2	47	17.68	68	
1800		230/460	145JPV	U138	145TTDR4037	√	\$429	S2	84.0	4.4/2.2	41	17.98	27,68	
1800		575	145JP	U136	145TTDR4048		\$386	S2	84.0	1.8	42	17.68		
1800		575	145JPV	U139	145TTDR4049		\$429	S2	84.0	1.8	42	17.98	27	
2		3600	200	145JP	U140	145TTDR4017		\$364	S2	84.0	6.2	45	16.18	
		3600	200	145JPV	U143	145TTDR4018		\$496	S2	84.0	6.2	45	16.48	27
	3600	230/460	145JP	U141	145TTDR4011		\$454	S2	84.0	5.4/2.7	45	16.18	68	
	3600	230/460	145JPV	U144	145TTDR4012		\$496	S2	84.0	5.4/2.7	45	16.48	27,68	
	3600	575	145JP	U142	145TTDR4023		\$454	S2	84.0	2.2	45	16.18		
	3600	575	145JPV	U145	145TTDR4024		\$496	S2	84.0	2.2	45	16.48	27	
	1800	200	145JP	U146	145TTDR4068		\$404	S2	84.0	6.7	45	18.18		
	1800	200	145JPV	U149	145TTDR4069		\$445	S2	84.0	6.7	45	18.48	27	
	1800	208-230/460	145JP	U147A	145TTDR4356	√	\$404	S2	84.0	6.2-5.8/2.9	44	17.98	68	
	1800	208-230/460	145JPV	U150A	145TTDR4355		\$445	S2	84.0	6.2-5.8/2.9	44	17.98	27,68	
	1800	575	145JP	U148	145TTDR4074		\$404	S2	84.0	2.3	44	18.18		
	1800	575	145JPV	U151	145TTDR4075		\$445	S2	84.0	2.3	44	18.48	27	
	3	3600	200	145JP	U152	145TTDR4117		\$507	S2	84.0	10.0	43	16.68	
3600		200	145JPV	U155	145TTDR4118		\$549	S2	84.0	10.0	43	16.98	27	
3600		230/460	145JP	U153	145TTDR4111	√	\$507	S2	84.0	8.4/4.2	42	16.68	68	
3600		230/460	145JPV	U156	145TTDR4112		\$549	S2	84.0	8.4/4.2	45	16.98	27,68	
3600		575	145JP	U154	145TTDR4123		\$507	S2	84.0	3.5	46	16.68		
3600		575	145JPV	U157	145TTDR4124		\$549	S2	84.0	3.5	45	16.98	27	
1800		200	182JP	U158	182TTDR4142		\$471	S2	86.5	9.4	51	19.66	13	
1800		200	182JPV	U161	182TTDR4143		\$555	S2	86.5	9.4	52	19.91	27	
1800		208-230/460	182JP	U159A	182TTDW4338		\$471	S2	86.5	9.0-8.8/4.4	70	17.46	13,68	
1800	230/460	182JPV	U162A	182TTDW4339		\$555	S2	86.5	8.8/4.4	85	18.01	13,27		

Catalog numbers (Cat No.) highlighted in bold blue have efficiency levels that meet EISA requirements

Continued on next page.

Close-Coupled Pump, JP, Three Phase

Dripproof, C-Face Footless (Vertical) and C-Face Footed (Rigid Base)

HP	RPM	VOLTS	FRAME	CAT. NO.	MODEL NO.	STOCK	LIST PRICE	MULT. SYMB.	NOM. EFF.	F.L. AMPS	WEIGHT	"C" DIM.	FOOT NOTES
3	1800	575	182JP	U160	182TTDR4148		\$471	S2	86.5	3.45	103	19.66	13
	1800	575	182JPV	U163	182TTDR4149		\$555	S2	86.5	3.45	102	19.91	13,27
5	3600	200	182JP	U164	182TTDR4118		\$608	S2	86.5	13.8	78	19.16	13
	3600	200	182JPV	U167	182TTDR4119		\$690	S2	86.5	13.8	81	19.84	13,27
	3600	208-230/460	182JP	U165A	182TTDW14011	√	\$608	S2	85.5	14.0-12.4/6.2	97	17.96	68
	3600	230/460	182JPV	U168	182TTDR4113		\$690	S2	86.5	12.0/6.0	85	19.84	27
	3600	575	182JP	U166	182TTDR4124		\$608	S2	86.5	4.8	76	19.16	13
	3600	575	182JPV	U169	182TTDR4125		\$690	S2	86.5	4.8	72	19.84	13,27
	1800	200	184JP	U170	184TTDR4142		\$608	S2	87.5	14.5	74	20.41	13
	1800	200	184JPV	U173	184TTDR4143		\$690	S2	87.5	14.5	72	20.84	27
	1800	208-230/460	184JP	M115A	184TTDW7358	√	\$487	S2	87.5	16.0-14.8/7.4	74	17.88	13,68
	1800	208-230/460	184JPV	U299	184TTDW4039		\$690	S2	87.5	14.5-13.2/6.6	87	21.66	27,68,98
	1800	230/460	184JP	U171A	184TTDW4136		\$608	S2	87.5	12.6/6.3	54	20.41	13
7 1/2	1800	575	184JP	U172	184TTDR4148		\$608	S2	87.5	5.3	69	20.16	13
	1800	575	184JPV	U175	184TTDR4149		\$690	S2	87.5	5.0	72	20.84	27
	3600	200	184JP	U176	184TTDR4117		\$731	S2	87.5	20.7	72	20.16	13
	3600	200	184JPV	U179	184TTDR4118		\$815	S2	87.5	20.2	72	20.84	27
	3600	208-230/460	184JP	U177A	184TTDW14079	√	\$731	S2	87.5	20.0-17.6/8.8	131	18.88	13,68
	3600	230/460	184JPV	U180	184TTDR4112		\$815	S2	87.5	17.6/8.8	131	20.32	27
	3600	575	184JP	U178	184TTDR4123		\$731	S2	87.5	7.2	131	20.16	13
	3600	575	184JPV	U181	184TTDR4124		\$815	S2	87.5	7.2	136	20.32	27
	1800	200	213JP	U182	213TTDW4044		\$879	S2	88.5	22.1	137	23.03	
	1800	200	213JPV	U185	213TTDW4051		\$990	S2	88.5	22.1	123	24.31	27
	1800	230/460	213JP	U183	213TTDW4049	√	\$879	S2	88.5	19.2/9.6	141	23.03	68
10	1800	230/460	213JPV	U186A	213TTDW14059		\$990	S2	88.5	19.4/9.2	141	23.03	27,68
	1800	575	213JP	U184	213TTDW4039		\$879	S2	88.5	7.6	138	23.03	
	1800	575	213JPV	U187	213TTDW4052		\$990	S2	88.5	7.7	140	24.31	27
	3600	200	213JP	U188	213TTDW4011		\$940	S2	88.5	26.9	130	23.03	
	3600	200	213JPV	U191	213TTDW4013		\$1,049	S2	88.5	26.9	130	24.31	27
	3600	208-230/460	213JP	U189A	213TTDW14013	√	\$940	S2	88.5	26.0-23.4/11.7	132	23.03	68
	3600	230/460	213JPV	U192	213TTDW4025		\$1,049	S2	88.5	23.4/11.7	134	24.31	27,68
	3600	575	213JP	U190	213TTDW4012		\$940	S2	88.5	9.4	135	23.03	
	3600	575	213JPV	U193	213TTDW4014		\$1,049	S2	88.5	9.3	130	24.31	27
	1800	200	215JP	U194	215TTDW4044		\$1,043	S2	89.5	28.8	156	23.03	
	1800	200	215JPV	U197	215TTDW4053		\$1,152	S2	89.5	28.8	163	24.31	27
15	1800	230/460	215JP	U195	215TTDW4049	√	\$1,043	S2	89.5	25.0/12.5	225	23.03	68
	1800	208-230/460	215JPV	U198A	215TTDW14073		\$1,152	S2	89.5	28.0-25.0/12.5	225	24.38	27,68
	1800	575	215JP	U196	215TTDW4051		\$1,043	S2	89.5	10.0	135	23.03	
	1800	575	215JPV	U199	215TTDW4052		\$1,152	S2	89.0	10.0	137	24.31	27
	3600	200	215JP	U200	215TTDW4011		\$1,161	S2	90.2	39.0	138	24.28	13,27
	3600	200	215JPV	U203	215TTDW4013		\$1,272	S2	90.2	39.1	139	25.56	27
	3600	230/460	215JP	U201A	215TTDW14020	√	\$1,161	S2	90.2	34.0/17.0	220	24.28	68
	3600	230/460	215JPV	U204	215TTDW4025		\$1,272	S2	90.2	34.0/17.0	135	25.56	27,68
	3600	575	215JP	U202	215TTDW4012		\$1,161	S2	90.2	13.6	168	24.28	
	3600	575	215JPV	U205	215TTDW4014		\$1,272	S2	90.2	13.6	215	25.56	27
	1800	200	254JP	U206	254TTDX4074		\$1,410	S2	91.0	44.0	220	27.04	
1800	200	254JPV	U209	254TTDX4060		\$1,571	S2	91.0	44.0	198	28.33	27	
1800	230/460	254JP	U207	254TTDX4075	√	\$1,410	S2	91.0	38.5/19.2	214	27.04		
1800	230/460	254JPV	U210	254TTDX4041	√	\$1,571	S2	91.0	38.5/19.2	224	28.33	27	
1800	575	254JP	U208	254TTDX4340		\$1,410	S2	91.0	15.4	260	27.04		
1800	575	254JPV	U211	254TTDX4341		\$1,571	S2	91.0	15.4	220	28.33	27	

Catalog numbers (Cat No.) highlighted in bold blue have efficiency levels that meet EISA requirements

Continued on next page.

PUMP MOTORS (FLUID HANDLING)

Close-Coupled Pump, JP, Three Phase

Dripproof, C-Face Footless (Vertical) and C-Face Footed (Rigid Base)

HP	RPM	VOLTS	FRAME	CAT. NO.	MODEL NO.	STOCK	LIST PRICE	MULT. SYMB.	NOM. EFF.	F.L. AMPS	WEIGHT	"C" DIM.	FOOT NOTES
20	3600	200	254JP	U212	254TTDX4014		\$1,465	S2	91.0	53.1	200	25.29	d,68,98
	3600	200	254JPV	U215	254TTDX4010		\$1,625	S2	91.0	53.1	200	26.58	27
	3600	230/460	254JP	U213	254TTDX4017	√	\$1,465	S2	91.0	46.0/23.1	213	25.29	
	3600	230/460	254JPV	U216	254TTDX4012		\$1,625	S2	91.0	46.0/23.1	150	26.58	27,68
	3600	575	254JP	U214	254TTDX4008		\$1,465	S2	91.0	18.0	203	25.29	
	3600	575	254JPV	U217	254TTDX4016		\$1,625	S2	91.0	18.5	200	26.58	27
	1800	200	256JP	U218	256TTDX4064		\$1,702	S2	91.0	60.0	225	27.04	
	1800	200	256JPV	U221	256TTDX4065		\$1,860	S2	91.0	59.8	235	28.33	27
	1800	230/460	256JP	U219	256TTDX4063	√	\$1,702	S2	91.0	52.0/26.0	328	27.04	68
	1800	575	256JP	U220	256TTDX4328		\$1,702	S2	91.0	20.8	136	27.04	
	1800	575	256JPV	U223	256TTDX4059		\$1,860	S2	91.0	20.8	220	28.33	27
25	3600	200	256JP	U224	256TTDX4022		\$1,723	S2	91.0	66.7	235	27.04	27
	3600	230/460	256JP	U225	256TTDX4004	√	\$1,723	S2	91.0	58.0/29.0	185	27.04	68
	3600	575	256JP	U226	256TTDX4023		\$1,723	S2	91.0	23.2	255	27.04	
1800	200	284JP	U227	284TTDP4044		\$2,058	S2	91.7	70.0	420	27.18		
	230/460	284JP	U228A	284TTDP14044	√	\$2,058	S2	91.7	61.0/30.5	310	27.18	68	
	575	284JP	U229	284TTDP4045		\$2,058	S2	91.7	24.5	348	27.18		
30	3600	200	284JP	U230	284TTDP4011		\$2,101	S2	91.0	83.0	361	27.18	27,68
	3600	230/460	284JP	U231	284TTDP4022	√	\$2,101	S2	91.0	72.0/36.0	368	27.18	68
	3600	575	284JP	U232	284TTDP4012		\$2,101	S2	91.0	29.0	428	27.18	
	1800	200	286JP	U233	286TTDP4048		\$2,377	S2	92.4	83.0	330	28.68	
	1800	230/460	286JP	U234	286TTDP4074	√	\$2,377	S2	92.4	72.0/36.0	331	28.68	68
	1800	575	286JP	U235	286TTDP4049		\$2,377	S2	92.4	28.8	425	28.68	
40	3600	230/460	286JP	U236	286TTDP4020	√	\$2,629	S2	91.7	94.0/47.0	428	28.68	68
	3600	575	286JP	U237	286TTDP4024		\$2,629	S2	91.7	38.0	327	28.68	
	1800	230/460	324JP	U238	324TTDP4348	√	\$3,106	S2	93.0	97.0/48.5	487	29.12	68
	1800	575	324JP	U239	324TTDP4033		\$3,106	S2	93.0	39.0	474	29.12	
50	3600	230/460	324JP	U240	324TTDP4002	√	\$3,364	S2	92.4	117/58.5	478	29.12	68
	3600	575	324JP	U241	324TTDP4011		\$3,385	S2	92.4	47.0	424	29.12	
	1800	230/460	326JP	U242	326TTDP4340	√	\$3,587	S2	93.0	123/61.5	585	30.62	68
	1800	575	326JP	U243	326TTDP4032		\$3,587	S2	93.0	49.0	490	30.62	

Close-Coupled Pump, JP, Three Phase

Totally Enclosed, C-Face Footed (Rigid Base)

Features:

- More ratings available, contact Marathon for price and availability
- NEMA JP pump shaft dimensions
- Ball bearings, mechanically locked on shaft end

- Continuous duty
- 1.15 Service Factor
- UL Recognized and CSA Certified



Suitable for use on VFD per guidelines on page 17.

HP	RPM	VOLTS	FRAME	CAT. NO.	MODEL NO.	STOCK	LIST PRICE	MULT. SYMB.	NOM. EFF.	F.L. AMPS	WEIGHT	"C" DIM.	FOOT NOTES
7 1/2	3600	200	213JP	U328	213TTFW4011		\$949	S2	89.5	21.2	96	25.96	
	3600	208-230/460	184JP	U372	184TTFW4914	√	\$767	S2	88.5	17.6-16.8/8.4	90	21.20	13,68
	3600	575	213JP	U332	213TTFW4012		\$949	S2	89.5	7.4	98	25.96	
15	3600	200	254JP	U343	254TTFW4009		\$1,451	S2	91.0	40.3	197	27.60	AL
	3600	208-230/460	215JP	U366	215TTFW14302		\$1,182	S2	90.2	40.0-37.0/18.5	193	25.96	68
	3600	230/460	254JP	U345A	254TTFW14008		\$1,451	S2	91.0	35.0/17.5	173	27.55	AL,68
	3600	575	254JP	U356	254TTFW4011		\$1,451	S2	91.0	14.0	173	27.60	AL

Catalog numbers (Cat No.) highlighted in bold blue have efficiency levels that meet EISA requirements

Blue shaded areas are Cast Iron Frames

Globetrotter® NEMA Premium® Efficiency Close-Coupled Pump, JP, Three Phase

Dripproof, C-Face Footed (Rigid Base)

Features:

- ☛ Meets or exceeds NEMA Premium® efficiencies NEMA Premium® models are in compliance with EISA2007
- Inverter Duty 10:1 Variable Torque and 2:1 Constant Torque, 1.0 SF
- Nameplated 60/50 hertz, 190/380 volts at next lower HP
- 1.15 Service Factor
- Class F Insulation
- Standard assembly F1, reversible to F2 assembly
- UL Recognized, CSA Certified, CE Mark
- Three year warranty

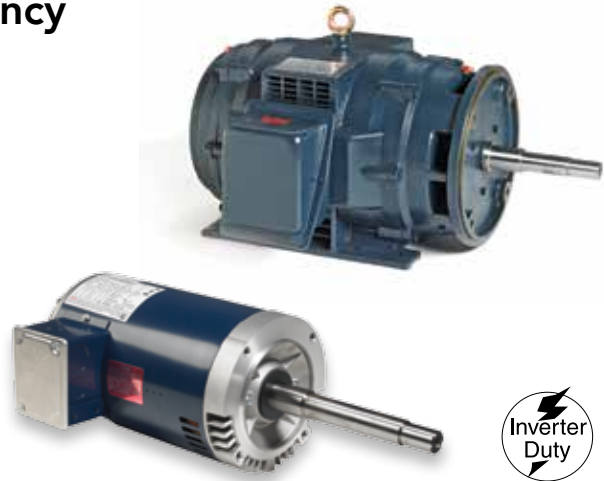

Suitable for use on VFD per guidelines on page 17.

HP	RPM	VOLTS	FRAME	CAT. NO.	MODEL NUMBER	STOCK	LIST PRICE	MULT. SYMB.	NOM. EFF.	F.L. AMPS	WEIGHT	"C" DIM.	FOOT NOTES
1	1800	200	143JP	GT2301	143TTDR16044	✓	\$415	S2	85.5	2.5	41	18.48	
	1800	200	143JPV	GT4301	143TTDR16045	✓	\$415	S2	85.5	2.5	41	18.48	
	1800	208-230/460	143JP	GT2401	143TTDR16048	✓	\$415	S2	85.5	3.2/1.6	41	18.48	
	1800	208-230/460	143JPV	GT4401	143TTDR16049	✓	\$415	S2	85.5	3.2/1.6	41	18.48	
	1800	575	143JP	GT2501	143TTDR16040	✓	\$415	S2	85.5	1.2	41	18.48	
	1800	575	143JPV	GT4501	143TTDR16041	✓	\$415	S2	85.5	1.2	41	18.48	
	1200	208-230/460	145JP	GT2402		✓	\$685	S2	82.5	3.8-4.4/2.2	41	18.68	
	1200	575	145JP	GT2502		✓	\$685	S2	82.5	1.8	41	18.68	
1 1/2	3600	200	143JP	GT2303	143TTDR16010	✓	\$474	S2	84.0	4.4	40	17.68	
	3600	200	143JPV	GT4303	143TTDR16011	✓	\$474	S2	84.0	4.4	40	17.68	
	3600	208-230/460	143JP	GT2403	143TTDR16015	✓	\$474	S2	84.0	4.0/2.0	40	17.68	
	3600	208-230/460	143JPV	GT4403	143TTDR16014	✓	\$474	S2	84.0	4.0/2.0	40	17.68	
	3600	575	143JP	GT2503	143TTDR16006	✓	\$474	S2	84.0	1.7	40	17.68	
	3600	575	143JPV	GT4503	143TTDR16008	✓	\$474	S2	84.0	1.7	40	17.68	
	1800	200	145JP	GT2304	145TTDR16075	✓	\$452	S2	86.5	5.6	44	18.18	
	1800	200	145JPV	GT4304	145TTDR16326	✓	\$452	S2	86.5	5.6	44	18.18	
	1800	208-230/460	145JP	GT2404	145TTDR16330	✓	\$452	S2	86.5	4.8/2.4	44	18.18	
	1800	208-230/460	145JPV	GT4404	145TTDR16331	✓	\$452	S2	86.5	4.8/2.4	44	18.18	
	1800	575	145JP	GT2504	145TTDR16327	✓	\$452	S2	86.5	1.8	44	18.18	
	1800	575	145JPV	GT4504	145TTDR16328	✓	\$452	S2	86.5	1.8	44	18.18	
2	1200	208-230/460	182JP	GT2405	182TTDB6085	✓	\$778	S2	86.5	4.4/2.2	101	19.06	
	1200	575	182JP	GT2505	182TTDB6095	✓	\$778	S2	86.5	1.8	101	19.06	
	3600	200	145JP	GT2306	145TTDR16014	✓	\$532	S2	85.5	5.2	43	16.18	
	3600	200	145JPV	GT4306	145TTDR16307	✓	\$532	S2	85.5	5.2	43	16.18	
	3600	208-230/460	145JP	GT2406	145TTDR16020	✓	\$532	S2	85.5	4.8/2.4	43	16.18	
	3600	208-230/460	145JPV	GT4406	145TTDR16021	✓	\$532	S2	85.5	4.8/2.4	43	16.18	
	3600	575	145JP	GT2506	145TTDR16017	✓	\$532	S2	85.5	2.0	43	16.18	
	3600	575	145JPV	GT4506	145TTDR16016	✓	\$532	S2	85.5	2.0	43	16.18	
	1800	200	145JP	GT2307	145TTDR16337	✓	\$512	S2	86.5	6.0	45	18.68	
	1800	200	145JPV	GT4307	145TTDR16342	✓	\$512	S2	86.5	6.0	45	18.68	
PUMP MOTORS (FLUID HANDLING)	1800	208-230/460	145JP	GT2407	145TTDR16333	✓	\$512	S2	86.5	5.8/2.9	45	18.68	
	1800	208-230/460	145JPV	GT4407	145TTDR16334	✓	\$512	S2	86.5	5.8/2.9	45	18.68	
	1800	575	145JP	GT2507	145TTDR16339	✓	\$512	S2	86.5	2.4	45	18.68	
	1800	575	145JPV	GT4507	145TTDR16340	✓	\$512	S2	86.5	2.4	45	18.68	
	1200	208-230/460	184JP	GT2408	184TTDB6085	✓	\$790	S2	87.5	5.8/2.9	110	20.05	
	1200	575	184JP	GT2508	184TTDB6095	✓	\$790	S2	87.5	2.3	110	20.05	

Catalog numbers (Cat No.) highlighted in bold blue have efficiency levels that meet EISA requirements

Continued on next page.

Globetrotter® NEMA Premium® Efficiency Close-Coupled Pump, JP, Three Phase Dripproof, C-Face Footed (Rigid Base)

HP	RPM	VOLTS	FRAME	CAT. NO.	MODEL NUMBER	STOCK	LIST PRICE	MULT. SYMB.	NOM. EFF.	F.L. AMPS	WEIGHT	"C" DIM.	FOOT NOTES	
3	3600	200	145JP	GT2309	145TTDR16024	✓	\$595	S2	86.5	8.0	47	13.62		
	3600	200	145JPV	GT4309	145TTDR16025	✓	\$595	S2	86.5	8.0	47	13.62		
	3600	208-230/460	145JP	GT2409	145TTDR16301	✓	\$595	S2	86.5	7.2/3.6	47	13.62		
	3600	208-230/460	145JPV	GT4409	145TTDR16306	✓	\$595	S2	86.5	7.2/3.6	47	13.62		
	3600	575	145JP	GT2509	145TTDR16303	✓	\$595	S2	86.5	2.8	47	13.62		
	3600	575	145JPV	GT4509	145TTDR16304	✓	\$595	S2	86.5	2.8	47	13.62		
	1800	208-230/460	182JP	GT2410	182TTDB6037	✓	\$566	S2	89.5	8.4-7.8/3.9	123	15.35		
	1800	575	182JP	GT2510	182TTDB6038	✓	\$566	S2	89.5	3.1	123	15.35		
	1200	230/460	213JP	GT2411	213TTDB6085	✓	\$1,087	S2	88.5	9.2-8.8/4.4	156	23.11		
	1200	575	213JP	GT2511	213TTDB6095	✓	\$1,087	S2	88.5	3.5	156	23.11		
	5	3600	208-230/460	182JP	GT2412	182TTDB6012	✓	\$715	S2	86.5	13.2-11.8/5.9	131	15.35	
		3600	575	182JP	GT2512	182TTDB6013	✓	\$715	S2	86.5	4.7	131	15.35	
1800		208-230/460	184JP	GT2413	184TTDB6037	✓	\$687	S2	89.5	13.6-12.4/6.2	135	16.34		
1800		575	184JP	GT2513	184TTDB6038	✓	\$687	S2	89.5	5.0	135	16.34		
1200		230/460	215JP	GT2414	215TTDB6085	✓	\$1,265	S2	89.5	15.2-14.0/7.0	281	23.11		
1200		575	215JP	GT2514	215TTDB6095	✓	\$1,265	S2	89.5	5.6	281	23.11		
7 1/2	3600	208-230/460	184JP	GT2415	184TTDB6012	✓	\$858	S2	88.5	19.0-17.2/8.6	149	16.34	A	
	3600	575	184JP	GT2515	184TTDB6013	✓	\$858	S2	88.5	6.9	149	16.34		
	1800	230/460	213JP	GT2416	213TTDB6037	✓	\$1,047	S2	91.0	20.4-18.6/9.3	166	17.68		
	1800	575	213JP	GT2516	213TTDB6038	✓	\$1,047	S2	91.0	7.5	166	17.68		
	1200	208-230/460	254JP	GT2417	254TTDCA6085	✓	\$1,582	S2	90.2	22.0-21.0/10.5	281	27.32		
	1200	575	254JP	GT2517	254TTDCA6095	✓	\$1,582	S2	90.2	8.4	281	27.32		
10	3600	208-230/460	213JP	GT2418	213TTDB6012	✓	\$1,106	S2	89.5	25.5-23/11.5	156	17.68		
	3600	575	213JP	GT2518	213TTDB6013	✓	\$1,106	S2	89.5	9.2	156	17.68		
	1800	230/460	215JP	GT2419	215TTDB6037	✓	\$1,225	S2	91.7	26.9-24.4/12.2	229	19.17		
	1800	575	215JP	GT2519	215TTDB6038	✓	\$1,225	S2	91.7	9.8	229	19.17		
	1200	208-230/460	256JP	GT2420	256TTDCA6085	✓	\$1,972	S2	91.7	29.6-27.6/13.8	305	28.90		
	1200	575	256JP	GT2520	256TTDCA6095	✓	\$1,972	S2	91.7	11.0	305	28.90		
15	3600	208-230/460	215JP	GT2421	215TTDB6012	✓	\$1,366	S2	90.2	38.0-34.0/17.0	191	19.17		
	3600	575	215JP	GT2521	215TTDB6013	✓	\$1,366	S2	90.2	13.6	191	19.17		
	1800	208-230/460	254JP	GT2422	254TTDCA6037	✓	\$1,646	S2	93.0	230/460	322	24.41		
	1800	575	254JP	GT2522	254TTDCA6038	✓	\$1,646	S2	93.0	15.2	322	24.41		
	1200	208-230/460	284JP	GT2423	284TTDCA6085	✓	\$2,597	S2	91.7	42.5-40.0/20.0	414	29.48		
	1200	575	284JP	GT2523	284TTDCA6095	✓	\$2,597	S2	91.7	16.0	414	29.48		
20	3600	208-230/460	254JP	GT2424	254TTDCA6012	✓	\$1,705	S2	91.0	51.0-46.0/23.0	312	24.41		
	3600	575	254JP	GT2524	254TTDCA6013	✓	\$1,705	S2	91.0	18.4	312	24.41		
	1800	208-230/460	256JP	GT2425	256TTDCA6037	✓	\$2,021	S2	93.0	53.0-49.0/24.5	374.4	26.00		
	1800	575	256JP	GT2525	256TTDCA6038	✓	\$2,021	S2	93.0	19.6	374.4	26.00		
	1200	208-230/460	286JP	GT2426	286TTDCA6085	✓	\$3,165	S2	92.4	58.0-54.0/27.0	457	29.99		
	1200	575	286JP	GT2526	286TTDCA6095	✓	\$3,165	S2	92.4	21.6	457	29.99		
25	3600	208-230/460	256JP	GT2427	256TTDCA6012	✓	\$2,062	S2	91.7	64.0-57.0/28.5	327.6	26.00		
	3600	575	256JP	GT2527	256TTDCA6013	✓	\$2,062	S2	91.7	22.8	327.6	26.00		
	1800	208-230/460	284JP	GT2428	284TTDCA6037	✓	\$2,412	S2	93.6	66.0-62.0/31.0	440.96	26.58		
	1800	575	284JP	GT2528	284TTDCA6038	✓	\$2,412	S2	93.6	24.8	440.96	26.58		
	1200	208-230/460	324JP	GT2429	324TTDCA6085	✓	\$3,770	S2	93.0	72.0-68.0/34.0	695	31.82		
	1200	575	324JP	GT2529	324TTDCA6095	✓	\$3,770	S2	93.0	27.2	695	31.82		

PUMP MOTORS (FLUID HANDLING)

Catalog numbers (Cat No.) highlighted in bold blue have efficiency levels that meet EISA requirements

Blue shaded areas are Cast Iron Frames

Continued on next page.

Globetrotter® NEMA Premium® Efficiency Close-Coupled Pump, JP, Three Phase

Dripproof, C-Face Footed (Rigid Base)

HP	RPM	VOLTS	FRAME	CAT. NO.	MODEL NUMBER	STOCK	LIST PRICE	MULT. SYMB.	NOM. EFF.	F.L. AMPS	WEIGHT	"C" DIM.	FOOT NOTES
30	3600	208-230/460	284JP	GT2430	284TTDCA6012	✓	\$2,462	S2	91.7	76.0-68.0/34.0	411.84	26.58	
	3600	575	284JP	GT2530	284TTDCA6013	✓	\$2,462	S2	91.7	27.2	411.84	26.58	
	1800	208-230/460	286JP	GT2431	286TTDCA6037	✓	\$2,786	S2	94.1	81.0-74.0/37.0	502.32	27.10	
	1800	575	286JP	GT2531	286TTDCA6038	✓	\$2,786	S2	94.1	29.6	502.32	27.10	
	1200	208-230/460	326JP	GT2432	326TTDCA6085	✓	\$4,416	S2	93.6	83.5-78.5/39.0	760	33.00	
	1200	575	326JP	GT2532	326TTDCA6095	✓	\$4,415	S2	93.6	32.5	760	33.00	
40	3600	208-230/460	286JP	GT2433	286TTDCA6012	✓	\$3,082	S2	92.4	100-90.0/45.0	470.08	27.10	
	3600	575	286JP	GT2533	286TTDCA6013	✓	\$3,082	S2	92.4	36.0	470.08	27.10	
	1800	208-230/460	324JP	GT2434	324TTDCA6037	✓	\$3,640	S2	94.1	105-95.0/47.5	604.24	28.95	
	1800	575	324JP	GT2534	324TTDCA6038	✓	\$3,640	S2	94.1	40.4	604.24	28.95	
50	3600	208-230/460	324JP	GT2436	324TTDCA6012	✓	\$3,943	S2	93.0	124-113/56.5	569.92	28.95	
	3600	575	324JP	GT2536	324TTDCA6013	✓	\$3,943	S2	93.0	45.0	569.92	28.95	
	1800	208-230/460	326JP	GT2437	326TTDCA6037	✓	\$4,205	S2	94.5	131-118/59.0	738.4	30.12	
	1800	575	326JP	GT2537	326TTDCA6038	✓	\$4,205	S2	94.5	47.0	738.4	30.12	

Catalog numbers (Cat No.) highlighted in bold blue have efficiency levels that meet EISA requirements

Blue shaded areas are Cast Iron Frames

Globetrotter® NEMA Premium® Efficiency Close-Coupled Pump, JP, Three Phase

TEFC, C-Face Footed (Rigid Base)

Features:

- ✦ Meets or exceeds NEMA Premium® efficiencies NEMA Premium® models are in compliance with EISA2007
- Inverter Duty 10:1 Variable Torque and 2:1 Constant Torque, 1.0 SF
- Dual rated motors are nameplated 60/50 hertz, 190/380 volts at next lower HP
- 1.15 Service Factor
- Class F Insulation
- Standard assembly F1, reversible to F2 assembly
- UL Recognized, CSA Certified, CE Mark
- Three year warranty



Suitable for use on VFD per guidelines on page 17.

PUMP MOTORS (FLUID HANDLING)

HP	RPM	VOLTS	FRAME	CAT. NO.	MODEL NUMBER	STOCK	LIST PRICE	MULT. SYMB.	NOM. EFF.	F.L. AMPS	WEIGHT	"C" DIM.	FOOT NOTES
1	1800	200	143JP	GT3301	143TTFR16049	✓	\$536	S2	85.5	3.8	59	19.13	
	1800	200	143JPV	GT5301	143TTFR16050	✓	\$529	S2	85.5	3.8	57	19.85	
	1800	208-230/460	143JP	GT3401	143TTFR16051	✓	\$536	S2	85.5	3.3/1.65	59	19.13	
	1800	208-230/460	143JPV	GT5401	143TTFR16043	✓	\$529	S2	85.5	3.3/1.65	57	19.85	
	1800	575	143JP	GT3501	143TTFR16044	✓	\$536	S2	85.5	1.3	59	19.13	
	1800	575	143JPV	GT5501	143TTFR16045	✓	\$529	S2	85.5	1.3	57	19.85	
	1200	208-230/460	145JP	GT3402		✓	\$824	S2	82.5	3.8/1.9	59	19.13	
	1200	575	145JP	GT3502		✓	\$824	S2	82.5	1.5	59	19.13	

Catalog numbers (Cat No.) highlighted in bold blue have efficiency levels that meet EISA requirements

Continued on next page.

Globetrotter® NEMA Premium® Efficiency Close-Coupled Pump, JP, Three Phase TEFC, C-Face Footed (Rigid Base)

HP	RPM	VOLTS	FRAME	CAT. NO.	MODEL NUMBER	STOCK	LIST PRICE	MULT. SYMB.	NOM. EFF.	F.L. AMPS	WEIGHT	"C" DIM.	FOOT NOTES
1 1/2	3600	200	143JP	GT3303	143TTFR16009	√	\$630	S2	84.0	4.6	63	18.63	
	3600	200	143JPV	GT5303	143TTFR16008	√	\$622	S2	84.0	4.6	61	19.35	
	3600	208-230/460	143JP	GT3403	143TTFR16011	√	\$630	S2	84.0	4.0/2.0	63	18.63	
	3600	208-230/460	143JPV	GT5403	143TTFR16012	√	\$622	S2	84.0	4.0/2.0	61	19.35	
	3600	575	143JP	GT3503	143TTFR16015	√	\$630	S2	84.0	1.6	63	18.63	
	3600	575	143JPV	GT5503	143TTFR16014	√	\$622	S2	84.0	1.6	61	19.35	
	1800	200	145JP	GT3304	145TTFR16060	√	\$587	S2	86.5	5.3	68	19.63	
	1800	200	145JPV	GT5304	145TTFR16061	√	\$580	S2	86.5	5.3	66	20.35	
	1800	208-230/460	145JP	GT3404	145TTFR16326	√	\$587	S2	86.5	4.6/2.3	68	19.63	
	1800	208-230/460	145JPV	GT5404	145TTFR16075	√	\$580	S2	86.5	4.6/2.3	66	20.35	
	1800	575	145JP	GT3504	145TTFR16064	√	\$587	S2	86.5	2.0	68	19.63	
	1800	575	145JPV	GT5504	145TTFR16065	√	\$580	S2	86.5	2.0	66	20.35	
	1200	230/460	182JP	GT3405	182TTFB6085	√	\$903	S2	87.5	4.6/2.3	108	19.07	
	1200	575	182JP	GT3505	182TTFB6095	√	\$903	S2	87.5	1.9	108	19.07	
2	3600	200	145JP	GT3306	145TTFR16016	√	\$682	S2	85.5	5.8	71	19.63	
	3600	200	145JPV	GT5306	145TTFR16011	√	\$674	S2	85.5	5.8	69	20.35	
	3600	208-230/460	145JP	GT3406	145TTFR16014	√	\$682	S2	85.5	5.2/2.6	71	19.63	
	3600	208-230/460	145JPV	GT5406	145TTFR16015	√	\$674	S2	85.5	5.2/2.6	69	20.35	
	3600	575	145JP	GT3506	145TTFR16021	√	\$682	S2	85.5	2.0	71	19.63	
	3600	575	145JPV	GT5506	145TTFR16019	√	\$674	S2	85.5	2.0	69	20.35	
	1800	200	145JP	GT3307	145TTFR16068	√	\$614	S2	86.5	7.6	76	20.13	
	1800	200	145JPV	GT5307	145TTFR16069	√	\$606	S2	86.5	7.6	74	20.85	
	1800	208-230/460	145JP	GT3407	145TTFR16056	√	\$614	S2	86.5	6.0/3.0	76	20.13	
	1800	208-230/460	145JPV	GT5407	145TTFR16055	√	\$606	S2	86.5	6.0/3.0	74	20.85	
	1800	575	145JP	GT3507	145TTFR16072	√	\$614	S2	86.5	2.4	76	20.13	
	1800	575	145JPV	GT5507	145TTFR16073	√	\$606	S2	86.5	2.4	74	20.85	
	1200	208-230/460	184JP	GT3408	184TTFB6085	√	\$944	S2	88.5	6.0/3.0	117	20.05	
	1200	575	184JP	GT3508	184TTFB6095	√	\$944	S2	88.5	2.4	117	20.05	
3	3600	208-230/460	182JP	GT3409	182TTFB6012	√	\$782	S2	86.5	7.6/3.8	83	19.07	
	3600	575	182JP	GT3509	182TTFB6013	√	\$782	S2	86.5	3.1	83	19.07	
	1800	208-230/460	182JP	GT3410	182TTFB6037	√	\$715	S2	89.5	7.8/3.9	87	19.07	
	1800	575	182JP	GT3510	182TTFB6038	√	\$715	S2	89.5	3.1	87	19.07	
	1200	208-230/460	213JP	GT3411	213TTFB6085	√	\$1,100	S2	89.5	8.6/4.3	164	24.54	
	1200	575	213JP	GT3511	213TTFB6095	√	\$1,100	S2	89.5	3.5	164	24.54	
5	3600	208-230/460	184JP	GT3412	184TTFB6012	√	\$928	S2	88.5	12.0/6.0	95	20.05	
	3600	575	184JP	GT3512	184TTFB6013	√	\$928	S2	88.5	4.8	95	20.05	
	1800	208-230/460	184JP	GT3413	184TTFB6037	√	\$864	S2	89.5	12.4/6.2	110	20.05	
	1800	575	184JP	GT3513	184TTFB6038	√	\$864	S2	89.5	5.0	110	20.05	
	1200	208-230/460	215JP	GT3414	215TTFB6085	√	\$1,329	S2	89.5	14.0/7.0	174	26.03	
	1200	575	215JP	GT3514	215TTFB6095	√	\$1,329	S2	89.5	5.6	174	26.03	
7 1/2	3600	208-230/460	213JP	GT3415	213TTFB6012	√	\$1,158	S2	88.5	12.0/6.0	116	24.54	
	3600	575	213JP	GT3515	213TTFB6013	√	\$1,158	S2	88.5	4.8	116	24.54	
	1800	230/460	213JP	GT3416	213TTFB6037	√	\$1,324	S2	89.5	12.4/6.2	143	24.54	
	1800	575	213JP	GT3516	213TTFB6038	√	\$1,324	S2	89.5	5.0	143	24.54	
	1200	208-230/460	254JP	GT3417	254TTFCA6085	√	\$2,298	S2	91.0	21.0/10.5	315	29.51	
	1200	575	254JP	GT3517	254TTFCA6095	√	\$2,298	S2	91.0	8.4	315	29.51	

PUMP MOTORS (FLUID HANDLING)

Catalog numbers (Cat No.) highlighted in bold blue have efficiency levels that meet EISA requirements

Continued on next page.

Globetrotter® NEMA Premium® Efficiency Close-Coupled Pump, JP, Three Phase TEFC, C-Face Footed (Rigid Base)

HP	RPM	VOLTS	FRAME	CAT. NO.	MODEL NUMBER	STOCK	LIST PRICE	MULT. SYMB.	NOM. EFF.	F.L. AMPS	WEIGHT	"C" DIM.	FOOT NOTES
10	3600	208-230/460	215JP	GT3418	215TTFB6012	✓	\$1,416	S2	90.2	22.8/11.4	137	26.03	
	3600	575	215JP	GT3518	215TTFB6013	✓	\$1,416	S2	90.2	9.1	137	26.03	
	1800	230/460	215JP	GT3419	215TTFB6037	✓	\$1,584	S2	91.7	24.4/12.2	164	26.03	
	1800	575	215JP	GT3519	215TTFB6038	✓	\$1,584	S2	91.7	9.8	164	26.03	
15	1200	208-230/460	256JP	GT3420	256TTFCA6085	✓	\$2,807	S2	91.0	28.0/14.0	345	30.71	
	1200	575	256JP	GT3520	256TTFCA6095	✓	\$2,807	S2	91.0	11.2	345	30.71	
	3600	208-230/460	254JP	GT3421	254TTFCA6012	✓	\$1,770	S2	91.0	34/17.0	350	29.51	
	3600	575	254JP	GT3521	254TTFCA6013	✓	\$1,770	S2	91.0	13.6	350	29.51	
	1800	208-230/460	254JP	GT3422	254TTFCA6037	✓	\$2,147	S2	92.4	37/18.5	375	29.51	
	1800	575	254JP	GT3522	254TTFCA6038	✓	\$2,147	S2	92.4	14.8	375	29.51	
20	1200	208-230/460	284JP	GT3423	284TTFCA6085	✓	\$3,726	S2	91.7	41.0/20.5	475	33.82	
	1200	575	284JP	GT3523	284TTFCA6095	✓	\$3,726	S2	91.7	15.9	475	33.82	
	3600	208-230/460	256JP	GT3424	256TTFCA6012	✓	\$2,087	S2	91.0	46.0/23.0	375	30.71	
	3600	575	256JP	GT3524	256TTFCA6013	✓	\$2,087	S2	91.0	18.4	375	30.71	
	1800	208-230/460	256JP	GT3425	256TTFCA6037	✓	\$2,437	S2	93.0	48.0/24.0	425	30.71	
	1800	575	256JP	GT3525	256TTFCA6038	✓	\$2,437	S2	93.0	19.6	425	30.71	
25	1200	208-230/460	286JP	GT3426	286TTFCA6085	✓	\$4,540	S2	91.7	52.0/26.0	550	35.00	
	1200	575	286JP	GT3526	286TTFCA6095	✓	\$4,540	S2	91.7	20.8	550	35.00	
	3600	208-230/460	284JP	GT3427	284TTFCA6012	✓	\$2,383	S2	91.7	55.5/27.7	475	33.82	
	3600	575	284JP	GT3527	284TTFCA6013	✓	\$2,383	S2	91.7	22.4	475	33.82	
	1800	208-230/460	284JP	GT3428	284TTFCA6037	✓	\$2,606	S2	93.6	62.0/31.0	500	33.82	
	1800	575	284JP	GT3528	284TTFCA6038	✓	\$2,606	S2	93.6	24.4	500	33.82	
30	1200	208-230/460	324JP	GT3429	324TTFCA6085	✓	\$5,503	S2	93.0	67.0/33.5	675	35.81	
	1200	575	324JP	GT3529	324TTFCA6095	✓	\$5,503	S2	93.0	26.8	675	35.81	
	3600	208-230/460	286JP	GT3430	286TTFCA6012	✓	\$2,492	S2	91.7	66.0/33.0	500	35.00	
	3600	575	286JP	GT3530	286TTFCA6013	✓	\$2,492	S2	91.7	27.2	500	35.00	
	1800	208-230/460	286JP	GT3431	286TTFCA6037	✓	\$2,816	S2	93.6	73.0/36.5	525	35.00	
	1800	575	286JP	GT3531	286TTFCA6038	✓	\$2,816	S2	93.6	29.2	252	35.00	
40	1200	208-230/460	326JP	GT3432	326TTFCA6085	✓	\$6,337	S2	93.0	80.0/40.0	725	36.99	
	1200	575	326JP	GT3532	326TTFCA6095	✓	\$6,337	S2	93.0	32	725	36.99	
	3600	208-230/460	324JP	GT3433	324TTFCA6012	✓	\$3,122	S2	92.4	88.0/44.0	675	35.81	
	3600	575	324JP	GT3533	324TTFCA6013	✓	\$3,122	S2	92.4	35.0	675	35.81	
	1800	208-230/460	324JP	GT3434	324TTFCA6037	✓	\$3,680	S2	94.1	94.0/47.0	750	35.81	
	1800	575	324JP	GT3534	324TTFCA6038	✓	\$3,680	S2	94.1	37.5	750	35.81	
50	3600	208-230/460	326JP	GT3436	326TTFCA6012	✓	\$3,993	S2	93.0	109/54.5	725	36.99	
	3600	575	326JP	GT3536	326TTFCA6013	✓	\$3,993	S2	93.0	43.5	725	36.99	
	1800	208-230/460	326JP	GT3437	326TTFCA6037	✓	\$4,255	S2	94.5	119/59.5	775	36.99	
	1800	575	326JP	GT3537	326TTFCA6038	✓	\$4,255	S2	94.5	47.5	775	36.99	

Catalog numbers (Cat No.) highlighted in bold blue have efficiency levels that meet EISA requirements

Blue shaded areas are Cast Iron Frames

PUMP MOTORS (FLUID HANDLING)

Dimensions

Definite Purpose - Close Coupled Pump Motors

Typical Close Coupled Pump Motor

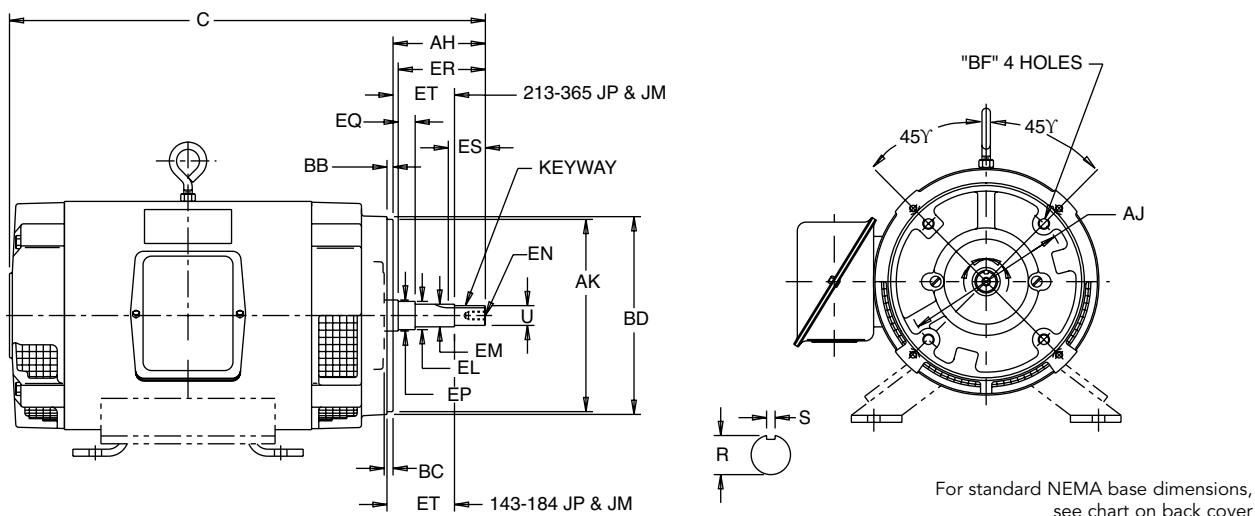

For standard NEMA base dimensions, see chart on back cover

Dimensions for Type JM

Frame Desig.	U	AH	AJ	AK	BB	BD Max.	BF			EL	EM	EN			EP Min.	EQ	ER Min.	Keyseat			ET
							No.	Tap Size	Bolt Pen. Allow.			Tap Size	Tap Drill Depth Max.	Bolt Pen. Allow.				R	ES Min.	S	
143 & 145	0.8745	4.15	5.890	4.500	0.150	6.62	4	3/8-16	0.56	1.156	1.0000	3/8-16	1.12	0.75	1.156	0.640	4.25	0.771	1.65	0.190	2.890
182 & 184	0.8745	4.13	5.89	4.500	0.16	6.62	4	3/8-16	0.56	1.250	1.0000	3/8-16	1.12	0.75	1.250	0.640	4.25	0.771	1.65	0.190	2.890
213 & 215	0.8750	4.25	7.265	8.500	0.312	9.00	4	1/2-13	0.75	1.248	0.9995	3/8-16	1.12	0.75	1.750	0.610	4.25	0.756	1.65	0.188	2.860
254 & 256	1.2495	5.25	7.250	8.500	0.312	10.00	4	1/2-13	0.75	1.748	1.3745	1/2-13	1.50	1.00	1.750	0.610	5.25	1.097	2.53	0.250	2.985
284 & 286	1.2495	5.281	11.00	12.500	0.312	14.00	4	5/8-11	0.94	1.750	1.3750	1/2-13	1.50	1.00	2.125	0.645	5.25	1.112	2.53	0.252	3.020
324 & 326	1.2495	5.281	11.00	12.500	0.312	14.00	4	5/8-11	0.94	1.750	1.3750	1/2-13	1.50	1.00	2.125	0.645	5.25	1.112	2.53	0.252	3.020
	1.2490	5.219	11.00	12.495	0.250					1.478	1.3745				2.125	0.605	5.25	1.097	2.53	0.250	2.980

Dimensions for Type JP

Frame Desig.	U	AH	AJ	AK	BB	BD Max.	BF			EL	EM	EN			EP Min.	EQ	ER Min.	Keyseat			ET
							No.	Tap Size	Bolt Pen. Allow.			Tap Size	Tap Drill Depth Max.	Bolt Pen. Allow.				R	ES Min.	S	
143 & 145	0.8745	7.19	5.890	4.500	0.156	6.62	4	3/8-16	0.56	1.156	1.0000	3/8-16	1.12	0.75	1.156	1.578	7.312	0.771	1.65	0.190	5.952
182 & 184	0.8745	7.21	5.890	4.500	0.156	6.62	4	3/8-16	0.56	1.250	1.0000	3/8-16	1.12	0.75	1.250	1.578	7.312	0.771	1.65	0.190	5.952
213 & 215	1.2495	8.12	7.250	8.500	0.312	9.00	4	1/2-13	0.75	1.248	0.9995	3/8-16	1.12	0.75	1.750	1.548	8.125	0.756	1.65	0.188	5.922
254 & 256	1.2495	8.156	7.250	8.500	0.312	10.00	4	1/2-13	0.75	1.748	1.3745	1/2-13	1.50	1.00	1.750	2.390	8.125	1.097	2.53	0.250	5.860
284 & 286	1.2495	8.156	11.00	12.500	0.312	14.00	4	5/8-11	0.94	1.750	1.3750	1/2-13	1.50	1.00	2.125	2.360	8.125	1.097	2.53	0.250	5.855
324 & 326	1.2495	8.12	11.00	12.500	0.312	14.00	4	5/8-11	0.94	1.750	1.3750	1/2-13	1.50	1.00	2.125	2.390	8.125	1.112	2.53	0.252	5.895
364 & 365	1.6245	8.12	11.00	12.500	0.312	14.00	4	5/8-11	0.94	2.125	1.7500	1/2-13	1.50	1.00	2.500	2.395	8.125	1.416	2.53	0.377	5.895
	1.6240			12.495	0.250					2.13	1.7495				2.355	8.125	1.401	2.53	0.375	5.855	

PUMP MOTORS (FLUID HANDLING)

All dimensions are measured in inches. For "C" dimensions, refer to the appropriate catalog page. Certified drawings are available upon request - contact Marathon Motors for details.

Fire Pump, Three Phase

Dripproof, Rigid Base

Applications:

For use on pumps designed for fire pump duty and installed per NFPA-20. These Dripproof motors are intended for installation in relatively clean and dry environments. **Fire Pump motors are not recommended for use with variable frequency drives.**



Features:

- UL File EX5190, CSA File LR2025 and CE Mark
- 50°C ambient
- Ball bearings
- 1.15 Service Factor (except as noted)
- Red paint on 25 HP through 200 HP
- NEMA Design B, Code G or less
- Dual voltage motors have 12 leads, suitable for wye-delta or across the line start on either voltage, or part winding start on low voltage
- Single voltage motors have 12 leads and are suitable for wye-delta, across the line, or part winding start
- Will accept C-Face kits (except as noted), see Accessories section for kits
- 230/460 and 460 Volt models rated for 50 HZ at next lower HP, 1.15 SF as noted

HP	RPM	VOLTS	FRAME	CAT. NO.	MODEL NO.	STOCK	LIST PRICE	MULT. SYMB.	NOM. EFF.	F.L. AMPS	WEIGHT	"C" DIM.	FOOT NOTES
25	3600	200/400	256T	U501	256TTDX4020		\$1,750	E2	91.0	66.5/33.5	126	22.32	
	3600	230/460	256T	U500	256TTDX4024	√	\$1,750	E2	91.0	58.0/29.0	164	22.32	68
	1800	200/400	284T	U503	284TTDP4047		\$1,733	E2	91.7	70/35.0	420	23.49	
	1800	230/460	284T	U502	284TTDP4027		\$1,733	E2	91.7	61.0/30.5	423	23.49	68
30	3600	230/460	284TS	U504	284TSTDP4002	√	\$2,088	E2	91.0	72.0/36.0	460	22.06	68
	3600	200/400	284TS	U505	284TSTDP4007		\$2,088	E2	91.0	83/41.5	460	22.06	68
	1800	200/400	286T	U507	286TTDP14042		\$2,016	E2	92.4	83.0/41.5	331	24.99	68
	1800	230/460	286T	U506	286TTDP4041		\$2,016	E2	92.4	72.0/36.0	331	24.99	68
40	3600	200/400	286TS	U509	286TSTDP4023	√	\$2,672	E2	91.7	108/54.0	360	23.56	
	3600	230/460	286TS	U508	286TSTDP4022	√	\$2,672	E2	91.7	94.0/47.0	332	23.56	68
	1800	200/400	324T	U511	324TTDP14049		\$2,507	E2	93.0	112/56.0	465	26.00	
	1800	230/460	324T	U510	324TTDP4038	√	\$2,507	E2	93.0	97.0/48.5	465	26.00	68
50	3600	200/400	324TS	U513	324TSTDP4007	√	\$3,176	E2	92.4	135/67.5	414	24.50	
	3600	230/460	324TS	U512	324TSTDP4010	√	\$3,176	E2	92.4	117/58.5	414	24.50	68
	1800	200/400	326T	U515	326TTDP4344		\$2,922	E2	93.0	141/70.5	515	27.50	
	1800	230/460	326T	U514	326TTDP4345		\$2,922	E2	93.0	123/61.5	345	27.50	68
60	3600	200/400	326TS	U517	326TSTDP4022	√	\$3,611	E2	93.0	155/77.5	378	26.00	
	3600	230/460	326TS	U516	326TSTDP4024	√	\$3,611	E2	93.0	135/67.5	378	26.00	68
	1800	200/400	326TS	U521	326TSTDR14034		\$3,285	E2	93.6	167/83.5	418	29.50	
	1800	200/400	364TS	U519	364TSTDS4337		\$3,682	E2	93.6	166/83.0	699	26.50	
	1800	200/400	364T	U538	364TTDS14329		\$3,682	E2	93.6	166/83.0	716	28.62	
	1800	230/460	364T	U520	364TTDS4328		\$3,682	E2	93.6	144/72.0	716	28.62	68
	1800	230/460	364TS	U518	364TSTDS4332	√	\$3,682	E2	93.6	144/72.0	686	26.50	68

PUMP MOTORS (FLUID HANDLING)

Catalog numbers (Cat No.) highlighted in bold blue have efficiency levels that meet EISA requirements

Blue shaded areas are Cast Iron Frames

Continued on next page.

Fire Pump, Three Phase

Dripproof, Rigid Base

HP	RPM	VOLTS	FRAME	CAT. NO.	MODEL NO.	STOCK	LIST PRICE	MULT. SYMB.	NOM. EFF.	F.L. AMPS	WEIGHT	"C" DIM.	FOOT NOTES
75	3600	200/400	364TS	U523	364TSTDS4024	✓	\$4,949	E2	93.0	210/105	713	26.50	
	3600	230/460	364TS	U522	364TSTDS4025	✓	\$4,949	E2	93.0	183/91.5	950	26.50	68
	1800	200/400	365TS	U525	365TSTDS4347		\$4,485	E2	94.1	204/102	766	27.50	
	1800	230/460	365TS	U524	365TSTDS4332	✓	\$4,485	E2	94.1	177/88.5	772	27.50	68
100	3600	200/400	365TS	U527	365TSTDS4303	✓	\$6,501	E2	93.0	276/138	748	27.50	
	3600	200/400	365TS	Y647	365TSTDS7904	✓	\$5,943	E2	91.7	274/137	690	27.50	d
	3600	230/460	365TS	U526	365TSTDS4025	✓	\$6,501	E2	93.0	240/120	721	27.50	68
	1800	200/400	404TS	U529	404TSTDS4333	✓	\$5,807	E2	94.1	271/136	850	29.50	
	1800	230/460	404TS	U528	404TSTDS4332	✓	\$5,720	E2	94.1	236/118	1002	29.50	68
125	3600	200/400	404TS	U531	404TSTDS14008	✓	\$8,087	E2	93.6	327/163	949	29.50	
	3600	230/460	404TS	U530	404TSTDS4017	✓	\$8,087	E2	93.6	284/142	933	29.50	68
	1800	200/400	405TS	U533	405TSTDS4333		\$6,849	E2	94.5	336/168	1070	31.00	
	1800	230/460	405TS	U532	405TSTDS4332	✓	\$6,849	E2	94.5	292/146	925	31.00	68
150	3600	460	405TS	U534	405TSTDS4006	✓	\$9,838	E2	93.6	169	1004	31.00	68
	1800	460	444TS	U535	444TSTDS4332	✓	\$9,891	E2	95.0	173	1286	34.00	68
200	3600	460	444TS	U536	444TSTDS4010	✓	\$15,304	E2	94.5	225	1313	34.00	68
	1800	460	445TS	U537	445TSTDS4332	✓	\$12,496	E2	95.0	233	1414	36.00	68
250	3600	460	445TS	U539	445TSTDS14007	✓	\$15,937	E2	94.5	279	1608	36.00	68
	1800	460	445TS	U540	445TSTDS14051	✓	\$13,790	E2	95.4	287	1642	36.00	68
300	3600	460	447TS	H178	447TSTDN7001	✓	\$16,918	E6	95.0	332	1940	39.50	F,25,68
	1800	460	447TS	H812	447TSTDN7026	✓	\$15,976	E6	95.4	345	1994	39.50	F,25,68
350	3600	460	447TS	H193	447TSTDN7003	✓	\$19,379	E6	95.0	385	2013	39.50	F,25,68
	1800	460	447TS	H813	447TSTDN7027	✓	\$17,363	E6	95.4	400	2064	39.50	F,25,68
400	3600	460	447TS	H817	447TSTDN7005	✓	\$22,049	E6	95.4	440	2150	39.50	F,25,68
	1800	460	447TS	H814	447TSTDN7028	✓	\$20,152	E6	95.4	450	2220	39.50	F,25
450	3600	460	449TS	H818	449TSTDN7001	✓	\$23,550	E6	95.8	495	2544	44.50	F,TS,25,68
	1800	460	449TS	H815A	449TSTDN14033		\$23,169	E6	95.8	505	2937	44.50	F,TS,17,25
500	3600	460	449TS	H819A	449TSTDN14005	✓	\$28,591	E6	95.8	545	2892	44.50	F,TS,25
	1800	460	449TS	H816	449TSTDN7027		\$23,599	E6	95.8	560	2695	44.50	F,TS,17,25

Catalog numbers (Cat No.) highlighted in bold blue have efficiency levels that meet EISA requirements

Blue shaded areas are Cast Iron Frames

Fire Pump, Three Phase

TEFC, Rigid Base, EPAct

Applications:

For use on pumps designed for fire pump duty and installed per NFPA-20.

Fire Pump motors are not recommended for use with variable frequency drives.



Features:

- UL File EX5190, CSA File LR2025 and CE Mark
- Ball bearings
- 1.15 Service Factor
- Red paint exterior
- NEMA Design B, Code G or less
- Dual voltage motors have 12 leads, suitable for wye-delta or across the line start on either voltage, or part winding start on low voltage
- Single voltage motors have 12 leads and are suitable for wye-delta, across the line, or part winding start
- Will accept C- Face kits, see Accessories section
- 230/460 and 460 Volt models rated for 50 HZ at next lower HP, 1.15 SF
- For special designs, contact district sales office near you

HP	RPM	VOLTS	FRAME	CAT. NO.	MODEL NO.	STOCK	LIST PRICE	MULT. SYMB.	NOM. EFF.	F.L. AMPS	WEIGHT	"C" DIM.	FOOT NOTES
3	3600	230/460	182T	Y1600		√	\$901	E8	85.5	7.4/3.7	84	15.87	
	1800	230/460	182T	Y1601		√	\$662	E8	87.5	8.6/4.3	90	15.87	
5	3600	230/460	184T	Y1602		√	\$1,037	E8	87.5	12.2/6.1	108	15.87	
	1800	230/460	184T	Y1603		√	\$764	E8	87.5	13.0/6.5	123	15.87	
7.5	3600	230/460	213T	Y1604		√	\$1,312	E8	88.5	19.0/9.5	188	18.20	
	1800	230/460	213T	Y1605		√	\$975	E8	89.5	20.0/10.0	194	19.63	
10	3600	230/460	215T	Y1606		√	\$1,532	E8	89.5	24.0/12.0	217	19.63	
	1800	230/460	215T	Y1607		√	\$1,186	E8	89.5	25.0/12.5	227	22.63	
15	3600	230/460	254T	Y1608	254TTFPA14014	√	\$2,160	E8	90.2	35.0/17.5	370	23.69	
	1800	230/460	254T	Y1609	254TTFNA14336	√	\$1,749	E8	91.0	39.0/19.5	365	23.52	
20	3600	230/460	256T	Y1610	256TTFNA14022	√	\$2,610	E8	90.2	46.8/23.4	334	25.27	
	1800	230/460	256T	Y1611	256TTFNA14071	√	\$2,072	E8	91.0	50.0/25.0	420	25.27	
25	3600	230/460	284TS	Y1612	284TSTFPA14007	√	\$2,450	E8	91.0	59.0/29.5	384	24.89	
	1800	230/460	284T	Y1613	284TTFPA14055	√	\$2,253	E8	92.4	61.0/30.5	440	26.27	
30	3600	230/460	286TS	Y1614	286TSTFPA14006	√	\$2,714	E8	91.0	70.0/35.0	428	26.47	
	1800	230/460	286T	Y1615	286TTFNA14050	√	\$2,621	E8	92.4	72.0/36.0	494	27.84	
40	3600	230/460	324TS	Y1616	324TSTFPA14010	√	\$3,474	E8	91.7	92.0/46.0	520	27.47	
	1800	230/460	324T	Y1618	324TTFPA14071	√	\$3,259	E8	93.0	100/50.0	575	28.97	
50	3600	230/460	326TS	Y1619	326TSTFPA14013	√	\$4,129	E8	92.4	112/56.0	540	28.97	
	1800	230/460	326T	Y1621	326TTFS14046	√	\$3,799	E8	93.0	122/61.0	675	31.87	
60	3600	230/460	364TS	Y1622	364TSTFS14009	√	\$4,694	E8	93.0	138/69.0	875	29.38	
	1800	230/460	364T	Y1624	364TTFS14064	√	\$4,787	E8	93.6	142/71.0	975	31.50	
75	3600	230/460	365TS	Y1625	365TSTFS14009	√	\$6,434	E8	93.0	172/86.0	1000	30.38	
	1800	230/460	365T	Y1627	365TTFS14071	√	\$5,831	E8	94.1	176/88.0	1025	32.50	
100	3600	230/460	405TS	Y1628	405TSTFS14007	√	\$8,451	E8	93.6	224/112	1239	34.12	
	1800	230/460	405T	Y1630	405TTFS14328	√	\$7,436	E8	94.5	224/112	1267	37.12	

Catalog numbers (Cat No.) highlighted in bold blue have efficiency levels that meet EISA requirements

Continued on next page.

PUMP MOTORS (FLUID HANDLING)

Fire Pump, Three Phase

TEFC, Rigid Base, EPAct

HP	RPM	VOLTS	FRAME	CAT. NO.	MODEL NO.	STOCK	LIST PRICE	MULT. SYMB.	NOM. EFF.	F.L. AMPS	WEIGHT	"C" DIM.	FOOT NOTES
125	3600	460	444TS	Y1631		✓	\$10,513	E8	94.5	136	1750	37.50	
	1800	460	444T	Y1633		✓	\$8,904	E8	94.5	145	1805	43.35	
150	3600	460	445TS	Y1634	445TSTFN14013	✓	\$12,789	E8	94.5	165	2187	39.44	
	1800	460	445T	Y1636	445TTFN14337	✓	\$12,858	E8	95.0	170	2116	43.35	
200	3600	460	445TS	Y1637	445TSTFN14014	✓	\$19,895	E8	95.0	222	2300	39.44	
	1800	460	445T	Y1639	445TTFN14338	✓	\$16,245	E8	95.0	224	2311	43.35	
250	3600	460	449TS	Y1640	449TSTFS14012	✓	\$20,718	E8	95.4	275	2700	47.88	
	1800	460	449T	Y1642	449TTFS14055	✓	\$17,927	E8	95.0	290	2600	51.85	
300	3600	460	449TS	Y1643		✓	\$21,993	E8	95.4	330	2850	47.88	
	1800	460	449T	Y1645	449TTFS14057	✓	\$20,769	E8	95.4	335	3041	51.86	
350	3600	460	449TS	Y1646		✓	\$25,193	E8	95.4	380	3064	47.88	
	1800	460	449T	Y1648	449TTFS14056	✓	\$22,572	E8	95.4	400	3202	51.88	
400	3600	460	5011S	Y1649		✓	\$46,143	E8	95.4	432	5500	67.19	
	1800	460	5011L	Y1650		✓	\$40,124	E8	95.4	448	5800	67.19	
450	3600	460	5011L	Y1651		✓	\$47,433	E8	95.4	515	5845	67.19	
	1800	460	5011L	Y1652		✓	\$41,247	E8	95.4	495	5942	67.19	

Catalog numbers (Cat No.) highlighted in bold blue have efficiency levels that meet EISA requirements

Hydraulic Pump, Three Phase

TEFC, Rigid Base, EPAct

Applications:

For use on: Axial piston pumps, gear pumps, gerotor pumps, variable volume pumps, trash compactors and hydraulic power units. Our highly engineered pump motor is equipped with a special patent pending regreasing system and flange with interchangeable SAE pump pads and shaft bushings (250 frame and larger). The special flange will adapt to SAE A to E pump pads and the motor shafts have a standard machined bore that will adapt to a spline or internal keyway shaft extensions (250 frame and larger).



Features:

- Ball bearings
- Class F insulation
- 50Hz Voltages at next lower HP
- Rolled Steel and Cast Iron
- 3600 & 1800 RPM (2 and 4 pole)
- NEMA Design B
- 10:1 Constant Torque
- 1.15 Service Factor on sinewave, 1.0 Service Factor on IGBT power
- 254TYZ and larger frames IP55 Standard with (IP-56 as a factory modification)
- Two year warranty

Suitable for use on VFD per guidelines on page 17.

HP	RPM	VOLTS	FRAME	FLANGE TYPE	SHAFT TYPE	CAT. NO.	LIST PRICE	MULT. SYMB.	NOM. EFF.	F.L. AMPS	WEIGHT
1/2	3600	208-230/460	56YZ	2-Bolt SAE AA	Spline	U2000	\$387	S5	72.0	2.2-2.0/1.0	25
	3600	208-230/460	56YZ	4-Bolt SAE AA	Spline	U2001	\$387	S5	72.0	2.2-2.0/1.0	25
	3600	208-230/460	56YZ	2-Bolt SAE A	Spline	U2002	\$448	S5	72.0	2.2-2.0/1.0	27
	3600	208-230/460	56YZ	2-Bolt SAE B	Spline	U2003	\$512	S5	72.0	2.2-2.0/1.0	27
	1800	208-230/460	56YZ	2-Bolt SAE AA	Spline	U2004	\$356	S5	74.0	2.1-2.2/1.1	25

Catalog numbers (Cat No.) highlighted in bold blue have efficiency levels that meet EISA requirements

Continued on next page.

Hydraulic Pump, Three Phase

TEFC, Rigid Base, EPAct

HP	RPM	VOLTS	FRAME	FLANGE TYPE	SHAFT TYPE	CAT. NO.	LIST PRICE	MULT. SYMB.	NOM. EFF.	F.L. AMPS	WEIGHT
1/2	1800	208-230/460	56YZ	4-Bolt SAE AA	Spline	U2005	\$356	S5	74.0	2.1-2.2/1.1	25
	1800	208-230/460	56YZ	2-Bolt SAE A	Spline	U2006	\$405	S5	74.0	2.1-2.2/1.1	27
	1800	208-230/460	56YZ	2-Bolt SAE B	Spline	U2007	\$464	S5	74.0	2.1-2.2/1.1	27
3/4	3600	208-230/460	56YZ	2-Bolt SAE AA	Spline	U2008	\$425	S5	75.5	2.2-2.4/1.2	29
	3600	208-230/460	56YZ	4-Bolt SAE AA	Spline	U2009	\$425	S5	75.5	2.2-2.4/1.2	29
	3600	208-230/460	56YZ	2-Bolt SAE A	Spline	U2010	\$495	S5	75.5	2.2-2.4/1.2	29
	3600	208-230/460	56YZ	2-Bolt SAE B	Spline	U2011	\$508	S5	75.5	2.2-2.4/1.2	29
	1800	208-230/460	56YZ	2-Bolt SAE AA	Spline	U2012	\$434	S5	77.0	2.6-2.8/1.4	31
	1800	208-230/460	56YZ	4-Bolt SAE AA	Spline	U2013	\$434	S5	77.0	2.6-2.8/1.4	31
	1800	208-230/460	56YZ	2-Bolt SAE A	Spline	U2014	\$469	S5	77.0	2.6-2.8/1.4	31
1	1800	208-230/460	56YZ	2-Bolt SAE B	Spline	U2015	\$482	S5	77.0	2.6-2.8/1.4	31
	3600	208-230/460	56YZ	2-Bolt SAE AA	Spline	U2016	\$442	S5	75.5	3.0-3.2/1.6	35
	3600	208-230/460	56YZ	4-Bolt SAE AA	Spline	U2017	\$442	S5	75.5	3.0-3.2/1.6	35
	3600	208-230/460	56YZ	2-Bolt SAE A	Spline	U2018	\$482	S5	75.5	3.0-3.2/1.6	35
	3600	208-230/460	56YZ	2-Bolt SAE B	Spline	U2019	\$497	S5	75.5	3.0-3.2/1.6	35
	1800	208-230/460	56YZ	2-Bolt SAE AA	Spline	U2020	\$453	S5	82.5	3.2-3.0/1.5	39
	1800	208-230/460	56YZ	4-Bolt SAE AA	Spline	U2021	\$453	S5	82.5	3.2-3.0/1.5	39
	1800	208-230/460	56YZ	2-Bolt SAE A	Spline	U2022	\$488	S5	82.5	3.2-3.0/1.5	39
	1800	208-230/460	56YZ	2-Bolt SAE B	Spline	U2023	\$546	S5	82.5	3.2-3.0/1.5	39
	1800	208-230/460	143YZ	2-Bolt SAE AA	Spline	U2024	\$536	S5	82.5	3.2-3.0/1.5	39
	1800	208-230/460	143YZ	4-Bolt SAE AA	Spline	U2025	\$536	S5	82.5	3.2-3.0/1.5	39
	1800	208-230/460	143YZ	2-Bolt SAE A	Spline	U2026	\$569	S5	82.5	3.2-3.0/1.5	39
	1800	208-230/460	143YZ	2-Bolt SAE B	Spline	U2027	\$624	S5	82.5	3.2-3.0/1.5	39
1 1/2	3600	208-230/460	56YZ	2-Bolt SAE AA	Spline	U2028	\$481	S5	82.5	4.4-4.2/2.1	40
	3600	208-230/460	56YZ	4-Bolt SAE AA	Spline	U2029	\$481	S5	82.5	4.4-4.2/2.1	40
	3600	208-230/460	56YZ	2-Bolt SAE A	Spline	U2030	\$507	S5	82.5	4.4-4.2/2.1	40
	3600	208-230/460	56YZ	2-Bolt SAE B	Spline	U2031	\$534	S5	82.5	4.4-4.2/2.1	40
	3600	208-230/460	143YZ	2-Bolt SAE AA	Spline	U2032	\$520	S5	82.5	4.4-4.2/2.1	40
	3600	208-230/460	143YZ	4-Bolt SAE AA	Spline	U2033	\$520	S5	82.5	4.4-4.2/2.1	40
	3600	208-230/460	143YZ	2-Bolt SAE A	Spline	U2034	\$549	S5	82.5	4.4-4.2/2.1	40
	3600	208-230/460	143YZ	2-Bolt SAE B	Spline	U2035	\$556	S5	82.5	4.4-4.2/2.1	40
	1800	208-230/460	56YZ	2-Bolt SAE AA	Spline	U2036	\$490	S5	84.0	4.6-4.4/2.2	42
	1800	208-230/460	56YZ	4-Bolt SAE AA	Spline	U2037	\$490	S5	84.0	4.6-4.4/2.2	42
	1800	208-230/460	56YZ	2-Bolt SAE A	Spline	U2038	\$525	S5	84.0	4.6-4.4/2.2	42
	1800	208-230/460	56YZ	2-Bolt SAE B	Spline	U2039	\$578	S5	84.0	4.6-4.4/2.2	42
	1800	208-230/460	145YZ	2-Bolt SAE AA	Spline	U2040	\$634	S5	84.0	4.6-4.4/2.2	42
	1800	208-230/460	145YZ	4-Bolt SAE AA	Spline	U2041	\$634	S5	84.0	4.6-4.4/2.2	42
	1800	208-230/460	145YZ	2-Bolt SAE A	Spline	U2042	\$687	S5	84.0	4.6-4.4/2.2	42
	1800	208-230/460	145YZ	2-Bolt SAE B	Spline	U2043	\$741	S5	84.0	4.6-4.4/2.2	42
	2	3600	208-230/460	56YZ	2-Bolt SAE AA	Spline	U2044	\$494	S5	84.0	5.4-5.6/2.8
3600		208-230/460	56YZ	4-Bolt SAE AA	Spline	U2045	\$494	S5	84.0	5.4-5.6/2.8	45
3600		208-230/460	56YZ	2-Bolt SAE A	Spline	U2046	\$539	S5	84.0	5.4-5.6/2.8	45
3600		208-230/460	56YZ	2-Bolt SAE B	Spline	U2047	\$581	S5	84.0	5.4-5.6/2.8	45
1800		208-230/460	56YZ	2-Bolt SAE AA	Spline	U2048	\$503	S5	84.0	6.6-6.6/3.3	49

Catalog numbers (Cat No.) highlighted in bold blue have efficiency levels that meet EISA requirements

Blue shaded areas are Cast Iron Frames

Continued on next page.

Hydraulic Pump, Three Phase

TEFC, Rigid Base, EPAct

HP	RPM	VOLTS	FRAME	FLANGE TYPE	SHAFT TYPE	CAT. NO.	LIST PRICE	MULT. SYMB.	NOM. EFF.	F.L. AMPS	WEIGHT
	1800	208-230/460	56YZ	4-Bolt SAE AA	Spline	U2049	\$503	S5	84.0	6.6-6.6/3.3	49
	1800	208-230/460	56YZ	2-Bolt SAE A	Spline	U2050	\$547	S5	84.0	6.6-6.6/3.3	49
	1800	208-230/460	56YZ	2-Bolt SAE B	Spline	U2051	\$590	S5	84.0	6.6-6.6/3.3	49
	1800	208-230/460	145YZ	2-Bolt SAE AA	Spline	U2052	\$788	S5	84.0	6.6-6.6/3.3	49
2	1800	208-230/460	145YZ	4-Bolt SAE AA	Spline	U2053	\$788	S5	84.0	6.6-6.6/3.3	49
	1800	208-230/460	145YZ	2-Bolt SAE A	Spline	U2054	\$732	S5	84.0	6.6-6.6/3.3	49
	1800	208-230/460	145YZ	2-Bolt SAE B	Spline	U2055	\$737	S5	84.0	6.6-6.6/3.3	49
3	3600	208-230/460	182TYZ	2-Bolt SAE AA	Spline	U2056	\$898	S5	85.5	7.6-7.8/3.9	64
	3600	208-230/460	182TYZ	4-Bolt SAE AA	Spline	U2057	\$898	S5	85.5	7.6-7.8/3.9	64
	3600	208-230/460	182TYZ	2-Bolt SAE A	Spline	U2058	\$1,001	S5	85.5	7.6-7.8/3.9	64
	3600	208-230/460	182TYZ	2-Bolt SAE B	Spline	U2059	\$1,079	S5	85.5	7.6-7.8/3.9	64
	3600	208-230/460	182TYZ	2-Bolt SAE AA	Hollow Bore	U2060	\$878	S5	85.5	7.6-7.8/3.9	64
	3600	208-230/460	182TYZ	4-Bolt SAE AA	Hollow Bore	U2061	\$878	S5	85.5	7.6-7.8/3.9	64
	3600	208-230/460	182TYZ	2-Bolt SAE A	Hollow Bore	U2062	\$965	S5	85.5	7.6-7.8/3.9	64
	3600	208-230/460	182TYZ	2-Bolt SAE B	Hollow Bore	U2063	\$1,035	S5	85.5	7.6-7.8/3.9	64
	1800	208-230/460	182TYZ	2-Bolt SAE AA	Spline	U2064	\$903	S5	87.5	9.0-8.4/4.2	70
	1800	208-230/460	182TYZ	4-Bolt SAE AA	Spline	U2065	\$903	S5	87.5	9.0-8.4/4.2	70
	1800	208-230/460	182TYZ	2-Bolt SAE A	Spline	U2066	\$978	S5	87.5	9.0-8.4/4.2	70
	1800	208-230/460	182TYZ	2-Bolt SAE B	Spline	U2067	\$1,054	S5	87.5	9.0-8.4/4.2	70
	1800	208-230/460	182TYZ	2-Bolt SAE AA	Hollow Bore	U2068	\$857	S5	87.5	9.0-8.4/4.2	70
	1800	208-230/460	182TYZ	4-Bolt SAE AA	Hollow Bore	U2069	\$857	S5	87.5	9.0-8.4/4.2	70
	1800	208-230/460	182TYZ	2-Bolt SAE A	Hollow Bore	U2070	\$940	S5	87.5	9.0-8.4/4.2	70
	1800	208-230/460	182TYZ	2-Bolt SAE B	Hollow Bore	U2071	\$1,007	S5	87.5	9.0-8.4/4.2	70
5	3600	208-230/460	184TYZ	2-Bolt SAE AA	Spline	U2072	\$992	S5	87.5	14.0-12.4/6.2	72
	3600	208-230/460	184TYZ	4-Bolt SAE AA	Spline	U2073	\$992	S5	87.5	14.0-12.4/6.2	72
	3600	208-230/460	184TYZ	2-Bolt SAE A	Spline	U2074	\$1,106	S5	87.5	14.0-12.4/6.2	72
	3600	208-230/460	184TYZ	2-Bolt SAE B	Spline	U2075	\$1,192	S5	87.5	14.0-12.4/6.2	72
	3600	208-230/460	184TYZ	2-Bolt SAE AA	Hollow Bore	U2076	\$974	S5	87.5	14.0-12.4/6.2	72
	3600	208-230/460	184TYZ	4-Bolt SAE AA	Hollow Bore	U2077	\$974	S5	87.5	14.0-12.4/6.2	72
	3600	208-230/460	184TYZ	2-Bolt SAE A	Hollow Bore	U2078	\$1,078	S5	87.5	14.0-12.4/6.2	72
	3600	208-230/460	184TYZ	2-Bolt SAE B	Hollow Bore	U2079	\$1,165	S5	87.5	14.2-13.0/6.5	75
	1800	208-230/460	184TYZ	2-Bolt SAE AA	Spline	U2080	\$963	S5	87.5	14.2-13.0/6.5	75
	1800	208-230/460	184TYZ	4-Bolt SAE AA	Spline	U2081	\$963	S5	87.5	14.2-13.0/6.5	75
	1800	208-230/460	184TYZ	2-Bolt SAE A	Spline	U2082	\$1,044	S5	87.5	14.2-13.0/6.5	75
	1800	208-230/460	184TYZ	2-Bolt SAE B	Spline	U2083	\$1,125	S5	87.5	14.2-13.0/6.5	75
	1800	208-230/460	184TYZ	2-Bolt SAE AA	Hollow Bore	U2084	\$917	S5	87.5	14.2-13.0/6.5	75
	1800	208-230/460	184TYZ	4-Bolt SAE AA	Hollow Bore	U2085	\$917	S5	87.5	14.2-13.0/6.5	75
	1800	208-230/460	184TYZ	2-Bolt SAE A	Hollow Bore	U2086	\$1,010	S5	87.5	14.2-13.0/6.5	75
	1800	208-230/460	184TYZ	2-Bolt SAE B	Hollow Bore	U2087	\$1,088	S5	87.5	14.2-13.0/6.5	75
7 1/2	3600	208-230/460	213TYZ	2-Bolt SAE AA	Spline	U2088	\$1,784	S5	88.5	18.1-18.4/9.2	104
	3600	208-230/460	213TYZ	4-Bolt SAE AA	Spline	U2089	\$1,784	S5	88.5	18.1-18.4/9.2	104
	3600	208-230/460	213TYZ	2-Bolt SAE A	Spline	U2090	\$1,990	S5	88.5	18.1-18.4/9.2	104
	3600	208-230/460	213TYZ	2-Bolt SAE B	Spline	U2091	\$2,144	S5	88.5	18.1-18.4/9.2	104

Catalog numbers (Cat No.) highlighted in bold blue have efficiency levels that meet EISA requirements

Blue shaded areas are Cast Iron Frames

Continued on next page.

Hydraulic Pump, Three Phase

TEFC, Rigid Base, EPAct

HP	RPM	VOLTS	FRAME	FLANGE TYPE	SHAFT TYPE	CAT. NO.	LIST PRICE	MULT. SYMB.	NOM. EFF.	F.L. AMPS	WEIGHT
	3600	208-230/460	213TYZ	2-Bolt SAE AA	Hollow Bore	U2092	\$1,746	S5	88.5	18.1-18.4/9.2	104
	3600	208-230/460	213TYZ	4-Bolt SAE AA	Hollow Bore	U2093	\$1,746	S5	88.5	18.1-18.4/9.2	104
	3600	208-230/460	213TYZ	2-Bolt SAE A	Hollow Bore	U2094	\$2,029	S5	88.5	18.1-18.4/9.2	104
	3600	208-230/460	213TYZ	2-Bolt SAE B	Hollow Bore	U2095	\$2,312	S5	88.5	18.1-18.4/9.2	104
	1800	208-230/460	213TYZ	2-Bolt SAE AA	Spline	U2096	\$1,780	S5	89.5	21.6-20.0/10.0	110
	1800	208-230/460	213TYZ	4-Bolt SAE AA	Spline	U2097	\$1,780	S5	89.5	21.6-20.0/10.0	110
	1800	208-230/460	213TYZ	2-Bolt SAE A	Spline	U2098	\$1,928	S5	89.5	21.6-20.0/10.0	110
	1800	208-230/460	213TYZ	2-Bolt SAE B	Spline	U2099	\$2,078	S5	89.5	21.6-20.0/10.0	110
	1800	208-230/460	213TYZ	2-Bolt SAE AA	Hollow Bore	U2100	\$1,740	S5	89.5	21.6-20.0/10.0	110
	1800	208-230/460	213TYZ	4-Bolt SAE AA	Hollow Bore	U2101	\$1,740	S5	89.5	21.6-20.0/10.0	110
	1800	208-230/460	213TYZ	2-Bolt SAE A	Hollow Bore	U2102	\$2,004	S5	89.5	21.6-20.0/10.0	110
	1800	208-230/460	213TYZ	2-Bolt SAE B	Hollow Bore	U2103	\$2,277	S5	89.5	21.6-20.0/10.0	110
10	3600	208-230/460	215TYZ	2-Bolt SAE AA	Spline	U2104	\$2,022	S5	89.5	22.0-24.0-12.0	117
	3600	208-230/460	215TYZ	4-Bolt SAE AA	Spline	U2105	\$2,022	S5	89.5	22.0-24.0-12.0	117
	3600	208-230/460	215TYZ	2-Bolt SAE A	Spline	U2106	\$2,334	S5	89.5	22.0-24.0-12.0	117
	3600	208-230/460	215TYZ	2-Bolt SAE B	Spline	U2107	\$2,656	S5	89.5	22.0-24.0-12.0	117
	3600	208-230/460	215TYZ	2-Bolt SAE AA	Hollow Bore	U2108	\$2,004	S5	89.5	22.0-24.0-12.0	117
	3600	208-230/460	215TYZ	4-Bolt SAE AA	Hollow Bore	U2109	\$2,004	S5	89.5	22.0-24.0-12.0	117
	3600	208-230/460	215TYZ	2-Bolt SAE A	Hollow Bore	U2110	\$2,236	S5	89.5	22.0-24.0-12.0	117
	3600	208-230/460	215TYZ	2-Bolt SAE B	Hollow Bore	U2111	\$2,410	S5	89.5	22.0-24.0-12.0	117
	1800	208-230/460	215TYZ	2-Bolt SAE AA	Spline	U2112	\$1,861	S5	89.5	28.0-26.0-13.0	125
	1800	208-230/460	215TYZ	4-Bolt SAE AA	Spline	U2113	\$1,861	S5	89.5	28.0-26.0-13.0	125
	1800	208-230/460	215TYZ	2-Bolt SAE A	Spline	U2114	\$2,016	S5	89.5	28.0-26.0-13.0	125
	1800	208-230/460	215TYZ	2-Bolt SAE B	Spline	U2115	\$2,173	S5	89.5	28.0-26.0-13.0	125
	1800	208-230/460	215TYZ	2-Bolt SAE AA	Hollow Bore	U2116	\$1,820	S5	89.5	28.0-26.0-13.0	125
	1800	208-230/460	215TYZ	4-Bolt SAE AA	Hollow Bore	U2117	\$1,820	S5	89.5	28.0-26.0-13.0	125
	1800	208-230/460	215TYZ	2-Bolt SAE A	Hollow Bore	U2118	\$2,098	S5	89.5	28.0-26.0-13.0	125
	1800	208-230/460	215TYZ	2-Bolt SAE B	Hollow Bore	U2119	\$2,385	S5	89.5	28.0-26.0-13.0	125

Catalog numbers (Cat No.) highlighted in bold blue have efficiency levels that meet EISA requirements

Blue shaded areas are Cast Iron Frames

Hydraulic Pump, Three Phase

TEFC, Rigid Base, EPAct

These motors have a selectable pump pad and shaft bushing. The motor catalog number is for the motor only. You need to specify which kit that is needed. Motor plus Kit will equal a complete unit.

HP	RPM	VOLTS	FRAME	FLANGE TYPE	SHAFT TYPE	CAT. NO.	LIST PRICE	MULT. SYMB.	NOM. EFF.	F.L. AMPS	WEIGHT
15	3600	230/460	254TYZ	Selectable from charts on page 152		U2120	\$3,314	S5	90.2	35.0/17.5	167
	1800	230/460	254TYZ	Selectable from charts on page 152		U2130	\$3,071	S5	91.0	40.0/20.0	175
20	3600	230/460	256TYZ	Selectable from charts on page 152		U2140	\$3,789	S5	90.2	46.0/23.0	187
	1800	230/460	256TYZ	Selectable from charts on page 152		U2155	\$3,449	S5	91.0	51.0/25.5	201
25	3600	230/460	284TYZ	Selectable from charts on page 152		U2156	\$4,477	S5	91.0	58.0/29.0	210
	1800	230/460	284TYZ	Selectable from charts on page 152		U2171	\$4,009	S5	92.4	62.0/31.0	225
30	3600	230/460	286TYZ	Selectable from charts on page 152		U2172	\$4,636	S5	91.0	72.0/36.0	231
	1800	230/460	286TYZ	Selectable from charts on page 152		U2187	\$4,288	S5	92.4	74.0/37.0	254
40	3600	230/460	324TYZ	Selectable from charts on page 152		U2188	\$5,812	S5	91.7	94.0/47.0	289
	1800	230/460	324TYZ	Selectable from charts on page 152		U2203	\$5,398	S5	93.0	100/50.0	325
50	3600	230/460	326TYZ	Selectable from charts on page 152		U2204	\$6,761	S5	92.4	117/58.5	342
	1800	230/460	326TYZ	Selectable from charts on page 152		U2219	\$5,951	S5	93.0	122/61.0	390
60	3600	230/460	364TYZ	Selectable from charts on page 152		U2220	\$11,544	S5	93.0	141/70.5	880
	1800	230/460	364TYZ	Selectable from charts on page 152		U2247	\$11,273	S5	93.6	144/72.0	920
75	3600	230/460	365TYZ	Selectable from charts on page 152		U2248	\$11,532	S5	93.0	172/86.0	942
	1800	230/460	364TYZ	Selectable from charts on page 152		U2275	\$11,086	S5	94.1	178/89.0	1000
100	3600	230/460	405TYZ	Selectable from charts on page 152		U2276	\$17,245	S5	93.6	224/112	1148
	1800	230/460	405TYZ	Selectable from charts on page 152		U2303	\$15,638	S5	94.5	228/114	1273
125	3600	460	444TYZ	Selectable from charts on page 152		U2304	\$19,044	S5	94.5	137	1554
	1800	460	444TYZ	Selectable from charts on page 152		U2331	\$17,841	S5	94.5	142	1787
150	3600	460	445TYZ	Selectable from charts on page 152		U2332	\$21,228	S5	94.5	167	1878
	1800	460	445TYZ	Selectable from charts on page 152		U2359	\$18,794	S5	95.0	172	2070
200	3600	460	445TYZ	Selectable from charts on page 152		U2360	\$24,887	S5	95.0	222	2147
	1800	460	445TYZ	Selectable from charts on page 152		U2387	\$21,410	S5	95.0	225	2215
250	3600	460	449TYZ	Selectable from charts on page 152		U2388	\$30,145	S5	95.4	280	2512
	1800	460	449TYZ	Selectable from charts on page 152		U2415	\$28,135	S5	95.0	285	2811
300	3600	460	449TYZ	Selectable from charts on page 152		U2416	\$35,882	S5	95.4	330	2866
	1800	460	449TYZ	Selectable from charts on page 152		U2443	\$32,772	S5	95.4	338	3041
350	3600	460	449TYZ	Selectable from charts on page 152		U2444	\$39,612	S5	95.4	382	2959
	1800	460	449TYZ	Selectable from charts on page 152		U2471	\$37,029	S5	95.4	400	3211

Catalog numbers (Cat No.) highlighted in bold blue have efficiency levels that meet EISA requirements

Blue shaded areas are Cast Iron Frames

Hydraulic Pump, Three Phase

Pump Pad with Shaft Bushing Kits

These kits are required for any motor 15HP and larger.

SAE - Spline Shaft Bushings

SAE SIZE	FRAME SIZE						LIST PRICE	WEIGHT
	250	280	320	360	400	440		
A	A020-A	A020-A	A020-A	A020-A	A020-A	A020-A	\$425	35
AA	A020-AA						\$425	35
B	A020-B	A020-B	A020-B	A020-B	A020-B	A020-B	\$380	35
BB	A020-BB	A020-BB	A020-BB	A020-BB	A020-BB	A020-BB	\$380	38
C	A020-C	A020-C	A020-C	A020-C	A020-C	A020-C	\$299	38
CC				A020-CC	A020-CC	A020-CC	\$675	40
D				A020-D	A020-D	A020-D	\$675	85
E				A020-E	A020-E	A020-E	\$675	85

SAE - Hollow Bore Shaft Bushings

SAE SIZE	FRAME SIZE						LIST PRICE	WEIGHT
	250	280	320	360	400	440		
A	A030-A	A030-A	A030-A	A030-A	A030-A	A030-A	\$425	35
AA	A030-AA						\$425	35
B	A030-B	A030-B	A030-B	A030-B	A030-B	A030-B	\$380	38
BB	A030-BB	A030-BB	A030-BB	A030-BB	A030-BB	A030-BB	\$380	38
C	A030-C	A030-C	A030-C	A030-C	A030-C	A030-C	\$299	40
CC				A030-CC	A030-CC	A030-CC	\$675	85
D				A030-D	A030-D	A030-D	\$675	85
E				A030-E	A030-E	A030-E	\$675	85

Vertical Solid Shaft P-Base

Three Phase, Dripproof

Applications:

For use on: Vertical end suction, short couple, centrifugal, non-clog, mix flow, turbine, and propeller pumps. HP type shafts, per NEMA MG-1 18.625. HPH and TCV type shafts, single phase, and other modifications such as adding screens are also available through special order. Contact Marathon Motors for more information.



Features:

- Normal and Medium thrust
- EPAct and NEMA Premium efficiencies
- Ball bearings and angular contact bearings for medium thrust applications
- Class B insulation
- 1.15 Service Factor
- Suitable for 230 volt part winding start through 100 HP (dual voltage motors)
- Heavy duty lifting lugs
- Drip cover/canopy cap included
- UL Recognized and CSA Certified
- UL Listed for Fire Pump applications (except as noted)

EPAct Efficient, Normal Thrust															
HP	RPM	VOLTS	FRAME	CAT. NO.	MODEL NO.	STOCK	LIST PRICE	MULT. SYMB.	NOM. EFF.	F.L. AMPS	WEIGHT	DOWN THRUST	BASE DIA	"C" DIM.	FOOT NOTES
3	1800	230/460	182HP	M801A	182TTDR14027		\$870	S5	86.5	9.3/4.7	83	390	9.88	17.18	98
	1200	230/460	213HP	M802A	213TTDW14084		\$1,357	S5	86.5	8.4/4.2	104	560	9.88	20.30	98
5	3600	230/460	182HP	M803A	182TTDR14026		\$1,393	S5	87.5	13.0/6.5	87	310	9.88	17.68	98
	1800	230/460	184HP	M804A	184TTDR4173		\$1,338	S5	87.5	13.2/6.6	168	490	9.88	17.18	98
172	1200	230/460	215HP	M805A	215TTDW14087		\$1,916	S5	87.5	14.2/7.1	138	650	9.88	21.55	98
	1800	230/460	213HP	M807A	213TTDW14054		\$1,672	S5	88.5	19.2/9.6	335	560	9.88	20.30	98
10	1200	230/460	254HP	M808A	254TTDX14088		\$2,281	S5	88.5	21.4/10.7	210	720	9.88	24.30	
	1800	230/460	215HP	M810A	215TTDW4071		\$1,878	S5	89.5	25.0/12.5	120	560	9.88	20.30	98
15	1200	230/460	256HP	M811A	256TTDX4094		\$2,576	S5	90.2	28.0/14.0	238	720	9.88	24.30	
	3600	230/460	215HP	M813A	215TTDW14018		\$2,184	S5	89.5	34.0/17.0	80	520	9.88	21.55	98
20	1800	230/460	254HP	M814A	254TTDX14064		\$2,245	S5	91.0	38.5/19.2	227	640	9.88	24.30	
	1200	230/460	284HP	M815A	284TTDR14082		\$3,002	S5	90.2	39.0/19.5	486	800	12.55	27.06	98
	900	230/460	324HP	M820A	324TTDR14104		\$4,109	S5	90.2	60.0/30.0	465	1100	16.38	30.56	98
25	1800	230/460	256HP	M818A	256TTDX14039		\$2,561	S5	91.0	50.0/25.0	241	640	9.88	24.30	
	1200	230/460	286HP	M819A	286TTDR14081		\$3,652	S5	91.0	53.0/26.5	562	800	12.55	29.56	98
	900	230/460	324HP	M821A	256TTDX4310		\$2,525	S5	91.0	58.0/29.0	225	520	9.88	24.30	
30	1800	230/460	284HP	M822A	286TTDR14046		\$2,854	S5	91.7	66.0/33.0	289	700	12.55	27.06	98
	1200	230/460	324HP	M823A	324TTDR14080		\$3,968	S5	91.7	66.0/33.0	460	1000	16.38	30.06	98
	900	230/460	326HP	M824A	326TTDR14103		\$4,733	S5	90.2	73.0/36.5	611	1100	16.38	30.56	98
40	3600	230/460	284HP	M825A	284TTDR14011		\$2,764	S5	91.0	72.0/36.0	292	550	12.55	27.06	98
	1800	230/460	286HP	M826A	286TTDR14042		\$3,210	S5	92.4	72.0/36.0	520	700	12.55	29.56	98
	900	230/460	364HP	M828A	364TTDS14104		\$5,311	S5	91.0	82.0/41.0	700	1100	16.5	29.00	
50	3600	230/460	286HP	M829	286TTDR17009		\$3,613	S5	91.7	94.0/47.0	347	550	12.55	28.56	98
	1800	230/460	324HP	M830A	324TTDR14049		\$3,551	S5	93.0	97.0/48.5	480	800	16.38	30.06	98
	1200	230/460	364HP	M831A	364TTDS14081		\$5,535	S5	93.0	105/52.5	772	1000	16.5	29.00	
50	900	230/460	365HP	M832A	365TTDS14101		\$6,402	S5	91.0	106/53.0	770	1100	16.5	29.00	
	3600	230/460	324HP	M833A	324TTDR14010		\$4,167	S5	92.4	117/58.5	510	600	16.38	29.56	98
	1800	230/460	326HP	M834A	326TTDR14034		\$4,215	S5	93.0	123/61.5	386	800	16.38	30.56	98
50	1200	230/460	365HP	M835A	365TTDS14082		\$6,530	S5	93.0	130/65.0	725	1000	16.5	29.00	
	900	460	404HP	M836A	404TTDS14102		\$7,297	S5	91.7	70.0	790	1400	16.5	31.75	

PUMP MOTORS (FLUID HANDLING)

Catalog numbers (Cat No.) highlighted in bold blue have efficiency levels that meet EISA requirements

Blue shaded areas are Cast Iron Frames

Continued on next page.

Vertical Solid Shaft P-Base

Three Phase, Dripproof

EPAct Efficient, Normal Thrust

HP	RPM	VOLTS	FRAME	CAT. NO.	MODEL NO.	STOCK	LIST PRICE	MULT. SYMB.	NOM. EFF.	F.L. AMPS	WEIGHT	DOWN THRUST	BASE DIA	"C" DIM.	FOOT NOTES
60	3600	230/460	326HP	M837A	326TTDR14010		\$4,661	S5	93.0	135/67.5	589	600	16.38	30.56	98
	1800	230/460	364HP	M838A	364TTDR14032		\$4,868	S5	93.6	145/72.5	587	800	16.38	34.19	98
	1200	230/460	404HP	M839A	404TTDS14081		\$7,453	S5	93.6	144/72.0	1049	1200	16.50	31.75	
	900	230/460	405HP	M840	405TTDS7124		\$8,415	S5	92.4	166/83.0	1077	1400	16.50	31.75	
75	3600	230/460	364HP	M841A	364TTDS14011		\$5,832	S5	93.0	183/91.5	733	600	16.50	29.00	
	1800	230/460	365HP	M842A	365TTDS4328		\$5,926	S5	94.1	179/89.5	810	800	16.50	29.00	
	1200	230/460	405HP	M843A	405TTDS4376		\$8,767	S5	93.6	176/88.0	1097	1200	16.50	31.75	
	900	460	444HP	M844A	444TTDS14101		\$9,651	S5	93.6	95.0	1210	1600	16.38	36.02	
100	3600	230/460	365HP	M845A	365TTDS14009		\$7,860	S5	93.0	240/120	762	600	16.50	29.00	
	1800	230/460	404HP	M846B	404TTDS14074		\$7,487	S5	94.1	270/135	1162	900	16.50	35.64	
	1200	460	444HP	M847A	444TTDS14086		\$10,881	S5	94.1	118	1317	1400	16.38	36.02	
	900	460	445HP	M848	445TTDS7121		\$12,948	S5	93.6	128	1504	1600	16.38	36.02	
125	3600	460	404HP	M849A	404TTDS14005		\$9,876	S5	93.6	142	1009	600	16.50	31.75	
	1800	460	405HP	M850A	405TTDS14067		\$9,043	S5	94.5	147	1142	900	16.50	31.75	
	1200	460	445HP	M851A	445TTDS14087		\$12,920	S5	94.1	147	1385	1400	16.38	36.02	
	900	460	505P	M852	505UTDS805		\$17,208	S5	93.6	168	1976	1600	20.00	38.75	98
150	3600	460	405HP	M853A	405TTDS14003		\$11,998	S5	93.6	169	1071	600	16.50	31.75	
	1800	460	444HP	M854A	444TTDS14057		\$10,849	S5	95.0	176	1240	1000	16.38	36.02	
	1200	460	445HP	M855A	445TTDS17084		\$15,604	S5	94.5	178	1498	1400	16.38	36.02	
	900	460	505P	M856	505UTDS819		\$21,330	S5	93.6	191	2148	1600	20.00	38.75	98
200	3600	460	444HP	M857A	444TTDS14003		\$16,398	S5	94.5	225	1357	600	16.38	36.02	
	1800	460	445HP	M858A	445TTDS14063		\$14,744	S5	95.0	233	1395	1000	16.38	36.02	
	1200	460	505P	M859A	505UTDS14077		\$22,807	S5	94.5	240	2145	1400	20.00	38.75	98
	900	460	505P	M860	505UTDS5820		\$24,004	S5	93.6	268	1250	1600	20.00	38.75	98
250	3600	460	445HP	M861A	445TTDS14003		\$17,555	S5	94.5	279	1520	600	16.38	36.02	
	1800	460	445HP	M862A	445TTDS14062		\$15,584	S5	95.4	286	1550	1000	16.38	36.02	
	1200	460	505P	M863A	505UTDS3999		\$24,323	S5	95.4	295	2318	1400	20.00	38.75	98
	900	460	508P	M864	---		\$29,108	S5	94.5	308	1600	20.00	45.75	98	
300	1800	460	505P	M866A	---		\$18,771	S5	95.4	340	1000	20.00	38.75	98	
	1200	460	508P	M867A	---		\$28,052	S5	95.4	342	1400	20.00	45.75	98	
	900	460	508P	M868	---		\$34,426	S5	93.6	375	1600	20.00	45.75	NE,98	
350	3600	460	505P	M869A	---		\$26,619	S5	95.0	378	600	20.00	38.75	98	
	1800	460	505P	M870	---		\$21,824	S5	95.4	402	1000	20.00	38.75	98	
	1200	460	508P	M871A	---		\$32,512	S5	95.4	400	1400	20.00	45.75	98	
400	1800	460	505P	M873	---		\$26,188	S5	95.4	455	1000	20.00	38.75	98	
	1200	460	508P	M874	---		\$37,339	S5	95.0	460	1400	20.00	45.75	NE,98	

NEMA Premium Efficient, Normal Thrust

20	3600	230/460	256HP	M717			\$2,856	S5	91.0	47.0/23.5	326	640	9.88	24.30	
	1800	230/460	256HP	M718	256TTDN16053		\$3,252	S5	93.0	48.0/24.0	452	640	16.39	29.62	
	1200	230/460	286HP	M719			\$4,638	S5	92.4	53.0/26.5	743	800	16.38	29.56	
25	3600	230/460	256HP	M721			\$3,207	S5	91.7	58.0/29.0	357	520	9.88	24.30	
	1800	230/460	256HP	M722	256TTDN16011		\$3,625	S5	93.6	58.0/29.0	449	700	16.39	29.62	
	1200	230/460	286HP	M723			\$5,039	S5	93.0	66.0/33.0	581	1000	16.38	30.06	
75	3600	230/460	364HP	M741			\$7,406	S5	93.6	183/91.5	733	600	16.50	29.00	
	1800	230/460	365HP	M742	365TTDS16072		\$7,527	S5	95.0	174/87.0	800	800	16.50	33.65	
	1200	230/460	405HP	M743			\$11,134	S5	94.5	176/88.0	1097	1200	16.50	31.75	
125	3600	460	404HP	M749			\$12,543	S5	94.1	142	1009	600	16.50	31.75	
	1800	460	405HP	M750	405TTDS16070		\$11,484	S5	95.4	141	1142	900	16.38	35.64	

Catalog numbers (Cat No.) highlighted in bold blue have efficiency levels that meet EISA requirements

Blue shaded areas are Cast Iron Frames

Continued on next page.

Vertical Solid Shaft P-Base

Three Phase, Dripproof

NEMA Premium Efficient, Medium Thrust													
HP	RPM	VOLTS	FRAME	CAT. NO.	LIST PRICE	MULT. SYMB.	NOM. EFF.	F.L. AMPS	WEIGHT	DOWN THRUST	BASE DIA	"C" DIM.	FOOT NOTES
20	3600	230/460	256HP	M1420	\$4,429	S5	91.0	47.0/23.5	186	1950	9.88	28.26	
	1800	230/460	256HP	M1421	\$5,429	S5	93.0	50.0/25.0	241	2400	9.88	24.30	
	1200	230/460	286HP	M1422	\$7,742	S5	92.4	53.0/26.5	562	3000	12.55	29.56	
	900	230/460	324HP	M1423	\$8,710	S5	90.2	60.0/30.0	465	4125	16.38	30.56	NE
25	3600	230/460	256HP	M1424	\$5,353	S5	91.7	58.0/29.0	225	1950	9.88	24.30	
	1800	230/460	324HP	M1425	\$6,051	S5	93.6	66.0/33.0	289	2625	12.55	27.06	
	1200	230/460	324HP	M1426	\$8,412	S5	93.0	66.0/33.0	460	3750	16.38	30.06	
	900	230/460	326HP	M1427	\$10,034	S5	90.2	73.0/36.5	611	4125	16.38	30.56	NE
30	3600	230/460	284HP	M1428	\$5,859	S5	91.7	72.0/36.0	292	2063	12.55	27.06	
	1800	230/460	286HP	M1429	\$6,805	S5	94.1	72.0/36.0	520	2625	12.55	29.56	
	1200	230/460	326HP	M1430	\$9,303	S5	93.6	76.0/38.0	788	3750	16.38	35.62	
	900	230/460	364HP	M1431	\$11,258	S5	91.0	82.0/41.0	700	4125	16.5	29.00	NE
40	3600	230/460	286HP	M1432	\$7,660	S5	92.4	94.0/47.0	347	2063	12.55	28.56	
	1800	230/460	324HP	M1433	\$7,528	S5	94.1	97.0/48.5	480	3000	16.38	30.06	
	1200	230/460	364HP	M1434	\$11,735	S5	94.1	105/52.5	772	3750	16.5	29.00	
	900	230/460	365HP	M1435	\$13,571	S5	91.0	106/53.0	770	4125	16.5	29.00	NE
50	3600	230/460	324HP	M1436	\$8,833	S5	93.0	117/58.5	510	2250	16.38	29.56	
	1800	230/460	326HP	M1437	\$8,936	S5	94.5	123/61.5	386	3000	16.38	30.56	
	1200	230/460	365HP	M1438	\$13,843	S5	94.1	130/65.0	725	3750	16.5	29.00	
	900	230/460	404HP	M1439	\$15,470	S5	91.7	140/70.0	790	5250	16.5	31.75	NE
60	3600	230/460	364HP	M1440	\$4,661	S5	93.6	135/67.5	589	2250	16.38	30.56	
	1800	230/460	364HP	M1441	\$4,868	S5	95.0	145/72.5	587	3000	16.38	34.19	
	1200	460	404HP	M1442	\$7,453	S5	94.5	72.0	1049	4500	16.50	31.75	
	900	460	405HP	M1443	\$8,415	S5	92.4	83.0	1077	5250	16.50	31.75	NE
75	3600	230/460	364HP	M1444	\$5,832	S5	93.6	183/91.5	733	2250	16.50	29.00	
	1800	230/460	365HP	M1445	\$5,926	S5	95.0	179/89.5	810	3000	16.50	29.00	
	1200	460	444HP	M1446	\$8,767	S5	94.5	88.0	1097	4500	16.50	31.75	
	900	460	444HP	M1447	\$9,651	S5	93.6	95.0	1210	6000	16.38	36.02	NE
100	3600	230/406	365HP	M1448	\$7,860	S5	93.6	240/120	762	2250	16.50	29.00	
	1800	230/460	404HP	M1449	\$7,487	S5	95.4	230/118	1100	3375	16.50	31.75	
	1200	460	444HP	M1450	\$10,881	S5	95.0	118	1317	5250	16.38	36.02	
	900	460	445HP	M1451	\$12,948	S5	93.6	128	1504	6000	16.38	36.02	NE
125	3600	460	404HP	M1452	\$9,876	S5	94.1	142	1009	2250	16.50	31.75	
	1800	460	405HP	M1453	\$9,043	S5	95.4	147	1142	3375	16.50	31.75	
	1200	460	445HP	M1454	\$12,920	S5	95.0	147	1385	5250	16.38	36.02	
	900	460	505P	M1455	\$17,208	S5	93.6	168	1976	6000	20.00	38.75	NE,98
150	3600	460	405HP	M1456	\$11,998	S5	94.1	169	1071	2250	16.50	31.75	
	1800	460	444HP	M1457	\$10,849	S5	95.8	176	1240	3750	16.38	36.02	
	1200	460	445HP	M1458	\$15,604	S5	95.4	178	1498	5250	16.38	36.02	
	900	460	505P	M1459	\$21,330	S5	93.6	191	2148	6000	20.00	38.75	NE,98
200	3600	460	444HP	M1460	\$16,398	S5	95.0	225	1357	2250	16.38	36.02	
	1800	460	445HP	M1461	\$14,744	S5	95.8	233	1395	3750	16.38	36.02	
	1200	460	505P	M1462	\$22,807	S5	95.4	240	2145	5250	20.00	38.75	98
	900	460	505P	M1463	\$24,004	S5	93.6	268	1250	6000	20.00	38.75	NE,98

PUMP MOTORS (FLUID HANDLING)

Catalog numbers (Cat No.) highlighted in bold blue have efficiency levels that meet EISA requirements

Blue shaded areas are Cast Iron Frames

Continued on next page.

Vertical Solid Shaft P-Base

Three Phase, Dripproof

NEMA Premium Efficient, Medium Thrust													
HP	RPM	VOLTS	FRAME	CAT. NO.	LIST PRICE	MULT. SYMB.	NOM. EFF.	F.L. AMPS	WEIGHT	DOWN THRUST	BASE DIA	"C" DIM.	FOOT NOTES
250	3600	460	445HP	M1464	\$17,555	S5	95.0	279	1520	2250	16.38	36.02	
	1800	460	445HP	M1465	\$15,584	S5	95.8	286	1550	3750	16.38	36.02	
	1200	460	505P	M1466	\$24,323	S5	95.4	295	2318	5250	20.00	38.75	98
	900	460	508P	M1467	\$29,108	S5	94.5	308	1562	6000	20.00	45.75	NE,98
300	3600	460	445HP	M1468	\$20,567	S5	95.4	362	1900	2250	16.38	36.02	
	1800	460	505P	M1469	\$18,771	S5	95.8	340	1937	3750	20.00	38.75	98
	1200	460	508P	M1470	\$28,052	S5	95.4	342	2877	5250	20.00	45.75	98
	900	460	508P	M1471	\$34,426	S5	94.1	375	1988	6000	20.00	45.75	NE,98
350	3600	460	505P	M1472	\$26,619	S5	95.4	378	2375	2250	20.00	38.75	98
	1800	460	505P	M1473	\$21,824	S5	95.8	402	2421	3750	20.00	38.75	98
	1200	460	508P	M1474	\$32,512	S5	95.4	400	3596	5250	20.00	45.75	98
	900	460	508P	M1475	\$37,456	S5	94.1	422	2485	6000	20.00	45.75	NE,98
400	3600	460	505P	M1476	\$30,122	S5	95.8	491	2969	2250	20.00	38.75	98
	1800	460	505P	M1477	\$26,188	S5	95.8	455	3027	3750	20.00	38.75	98
	1200	460	508P	M1478	\$37,339	S5	95.8	460	4495	5250	20.00	45.75	98
	900	460	508P	M1479	\$42,556	S5	94.1	489	3106	6000	20.00	45.75	NE,98
500	3600	460	508P	M1480	\$35,766	S5	95.8	571	3711	2250	20.00	45.75	98
	1800	460	508P	M1481	\$31,224	S5	96.2	521	3783	3750	20.00	45.75	98
	1200	460	508P	M1482	\$41,990	S5	96.2	563	5619	5250	20.00	45.75	98
	900	460	508P	M1483	\$47,555	S5	94.1	591	3883	6000	20.00	45.75	NE,98

Catalog numbers (Cat No.) highlighted in bold blue have efficiency levels that meet EISA requirements

Blue shaded areas are Cast Iron Frames

Vertical Solid Shaft P-Base

Three Phase, Totally Enclosed

Applications:

For use on: Vertical end suction, short couple, centrifugal, non-clog, mix flow, turbine, and propeller pumps. Totally Enclosed, Fan Cooled construction restricts the free exchange of ambient air inside the motor. Suitable for demanding applications in the process industries. HP type shafts, per NEMA MG-1, 18.625. HPH type shafts, severe duty features, explosion proof, and other modifications such as adding screens are also available through special order. Contact Marathon Motors for more information.

Features:

- Normal thrust
- Class F insulation
- 1.15 Service Factor
- Suitable for 230 volt part winding start through 100 HP (dual voltage motors)
- Heavy duty lifting lugs
- Drip cover/canopy cap included
- UL Recognized and CSA Certified

EPAct Efficient, Normal Thrust															
HP	RPM	VOLTS	FRAME	CAT. NO.	MODEL NO.	STOCK	LIST PRICE	MULT. SYMB.	NOM. EFF.	F.L. AMPS	WEIGHT	DOWN THRUST	BASE DIA	"C" DIM.	FOOT NOTES
3	3600	230/460	182HP	M875A	182TTFW14005		\$1,291	S5	85.5	7.4/3.7	89	260	9.88	18.05	
	1800	230/460	182HP	M876A	182TTFW14026		\$1,132	S5	87.5	8.4/4.2	124	390	9.88	18.05	
	1200	230/460	213HP	M877A	213TTFW14080		\$1,766	S5	87.5	9.2/4.6	134	560	9.88	22.66	
5	1800	230/460	184HP	M879A	184TTFW14026		\$1,586	S5	87.5	13.0/6.5	79	490	9.88	20.05	
	1200	230/460	215HP	M880A	215TTFW14083		\$2,488	S5	87.5	14.0/7.0	139	650	9.88	23.91	
7 1/2	3600	230/460	213HP	M881A	213TTFW14010		\$2,245	S5	88.5	18.4/9.2	157	380	9.88	22.66	
	1200	230/460	254HP	M883A	254TTFNA14084		\$2,968	S5	89.5	19.6/9.8	401	720	9.88	28.26	
10	3600	230/460	215HP	M884A	215TTFW14021		\$2,445	S5	89.5	24.0/12.0	160	450	9.88	22.66	
	1800	230/460	215HP	M885A	215TTFW14040		\$2,445	S5	89.5	26.0/13.0	158	560	9.88	23.91	
	1200	230/460	256HP	M886A	256TTFNA14084		\$3,351	S5	89.5	26.0/13.0	420	720	9.88	28.26	
15	3600	230/460	254HP	M888	254TTFNA7012		\$2,818	S5	90.2	35.0/17.5	272	520	9.88	28.26	
	1200	230/460	284HP	M890A	284TTFPA14049		\$3,907	S5	90.2	36.0/18.0	400	800	9.88	28.88	
20	3600	230/460	256HP	M892A	256TTFNA14016		\$3,083	S5	90.2	47.0/23.5	413	520	9.88	28.26	
	1800	230/460	256HP	M893	256TTFNA7028		\$3,329	S5	91.0	50.0/25.0	587	640	9.88	28.26	
	1200	230/460	286HP	M894A	286TTFNA14085		\$4,748	S5	90.2	54.0/27.0	438	800	9.88	30.84	
25	3600	230/460	284HP	M896	284TTFNA7508		\$3,257	S5	91.0	57.0/28.5	520	550	9.88	30.84	
	1800	230/460	284HP	M897A	284TTFPA14048		\$3,710	S5	92.4	62.0/31.0	466	700	9.88	28.88	
	1200	230/460	324HP	M898A	324TTFPA14089		\$5,556	S5	91.7	67.0/33.5	610	1000	16.38	33.09	
	900	230/460	326HP	M899A	326TTFNA14103		\$6,627	S5	89.5	73.0/36.5	835	1100	16.38	35.62	
30	3600	230/460	286HP	M900A	286TTFPA14011		\$3,594	S5	91.0	72.0/36.0	550	550	9.88	27.38	
	1800	230/460	286HP	M901A	286TTFPA14063		\$4,174	S5	92.4	74.0/37.0	653	700	9.88	27.38	
	1200	230/460	326HP	M902A	326TTFNA14087		\$6,344	S5	91.7	76.0/38.0	788	1000	16.38	35.62	

Catalog numbers (Cat No.) highlighted in bold blue have efficiency levels that meet EISA requirements

Blue shaded areas are Cast Iron Frames

Continued on next page.

PUMP MOTORS (FLUID HANDLING)

Vertical Solid Shaft P-Base

Three Phase, Totally Enclosed

EPAct Efficient, Normal Thrust

HP	RPM	VOLTS	FRAME	CAT. NO.	MODEL NO.	STOCK	LIST PRICE	MULT. SYMB.	NOM. EFF.	F.L. AMPS	WEIGHT	DOWN THRUST	BASE DIA	"C" DIM.	FOOT NOTES
40	3600	230/460	324HP	M904A	324TTFS14003		\$4,744	S5	91.7	92.0/46.0	738	600	16.38	35.62	
	1800	230/460	324HP	M905A	324TTFPA14065		\$4,973	S5	93.0	100/50.0	761	800	16.38	33.09	
	1200	230/460	364HP	M906A	364TTFS14087		\$8,305	S5	93.0	102/51.0	934	1000	16.38	37.44	
	900	230/460	365HP	M907	365TTFS17102		\$9,604	S5	91.0	111/55.5	1112	1100	16.38	37.44	
50	1800	230/460	326HP	M909A	326TTFPA14049		\$5,897	S5	93.0	122/61.0	649	800	16.38	34.59	
	1200	230/460	365HP	M910A	365TTFS14084		\$9,792	S5	93.0	130/65.0	998	1000	16.38	37.44	
60	3600	230/460	364HP	M912A	364TTFS14003		\$6,993	S5	93.0	141/70.5	978	600	16.38	37.44	
	1800	230/460	364HP	M913A	364TTFS14058		\$7,297	S5	93.6	142/71.0	998	800	16.38	37.44	
	1200	230/460	404HP	M914A	404TTFS14088		\$11,929	S5	93.6	149/74.5	1232	1400	16.38	40.69	
75	3600	230/460	365HP	M916A	365TTFS7923		\$8,734	S5	93.0	174/87.0	1059	600	16.38	37.44	
	1800	230/460	365HP	M917A	365TTFS14060		\$8,890	S5	94.1	178/89.0	1130	800	16.38	37.44	
	1200	230/460	405HP	M918A	405TTFS14087		\$14,029	S5	93.6	185/92.5	1340	1400	16.38	40.69	
	900	460	444HP	M919	444TTFS7403		\$16,887	S5	93.0	97.0	1889	1600	16.38	45.81	
100	3600	230/460	405HP	M920	405TTFS7612		\$12,579	S5	93.6	220/110	1341	600	16.38	40.69	
	1800	230/460	405HP	M921A	405TTFS14063		\$11,977	S5	94.5	228/114	1430	900	16.38	40.69	
	1200	460	444HP	M922A	444TTFN14080		\$18,701	S5	94.1	124	1865	1400	16.38	43.50	
125	3600	460	444HP	M924	444TTFS7321		\$16,974	S5	94.5	137	1846	600	16.38	45.81	
	1800	460	444HP	M925A	444TTFN14044		\$15,546	S5	94.5	145	1756	1000	16.38	43.50	
	1200	460	445HP	M926A	445TTFN14086		\$22,607	S5	94.1	152	2248	1400	16.38	43.50	
150	3600	460	445HP	M928A	445TTFN14003		\$20,627	S5	94.5	167	1780	600	16.38	43.50	
	1800	460	445HP	M929A	445TTFN14326		\$18,988	S5	95.0	172	2292	1000	16.38	43.50	
	900	460	449HP	M931	449TTFS7109		\$39,890	S5	93.6	206	3290	1600	16.38	54.25	
200	1800	460	445HP	M933A	445TTFN14330		\$26,535	S5	95.0	225	2290	1000	16.38	43.50	

Catalog numbers (Cat No.) highlighted in bold blue have efficiency levels that meet EISA requirements

Blue shaded areas are Cast Iron Frames

Aeration Fan, Farm / Agricultural Duty, Single Phase TEAO, Rigid Base

Applications:

Direct drive vane axial fans. These totally enclosed/air over motors must be mounted within the airstream for proper cooling. These aeration fan motors are often used in agricultural applications.

Features:

- Capacitor start design for high starting torque
- 1.0 Service Factor except as noted
- UL Recognized and CSA Certified
- 18" Leads for ease of connection
- 56Z & 143-5TZ have keyway and 1/4" x 20" UNC tapped hole



HP	RPM	VOLTS	FRAME	OVER LOAD	CAT. NO.	MODEL NO.	STOCK	LIST PRICE	MULT. SYMB.	F.L. AMPS	WEIGHT	"C" DIM.	FOOT NOTES
3/4	3600	115/230	56Z	AUTO	C1467	5KC37NN3544T	✓	\$260	F1	9.8/4.9	20	11.26	10
1	3600	115/230	56Z	AUTO	C1468	5KC49NN2081T	✓	\$288	F1	13.0/6.5	26	11.74	10
1 1/2	3600	115/230	143TZ	AUTO	C1273	5KC49SN8060T	✓	\$581	S1	16.4/8.2	35	12.28	
2	3600	115/230	145TZ	AUTO	C1274	5KCR49TN8058T	✓	\$711	S1	17.8/8.9	37	12.28	1,18
3	3600	230	145T	AUTO	C1275	5KCR49ZN8061T	✓	\$969	S1	13.2	49	13.69	1,18

Attic Fan, Split Phase Open Air Over, Resilient Base

Features:

- Variable torque on two speed motors
- 48Y Frame has 48/56 Frame mounting holes
- 56YZ frame with 3" shaft height, 1/2" diameter shaft, and 5/8" adapter with keyway included
- UL Recognized and CSA Certified



HP	RPM	VOLTS	FRAME	OVER LOAD	CAT. NO.	MODEL NO.	STOCK	LIST PRICE	MULT. SYMB.	F.L. AMPS	WEIGHT	"C" DIM.	FOOT NOTES
1/3	1800/1200	115	48Y	AUTO	B402	48S17D7209	✓	\$209	F1	5.3/2.9	21	10.31	
	1800	115	48Y	AUTO	B400	48S17D997	✓	\$138	F1	6.6	14	9.34	
1/2	1800	115	56YZ	AUTO	B401	56S17D2062	✓	\$172	F1	7.8	18	10.47	53

Centrifugal Fan, Single Phase

Dripproof, Rigid Base

Applications:

Direct drive centrifugal fans installed in relatively clean and dry applications.

Features:

- Capacitor start/capacitor run design for high starting torque and low amps
- Ball bearings, mechanically locked on shaft end
- 84" leads
- Heavy gauge steel frame and base
- Shafts are 1" longer than NEMA standard for extra clearance
- Rodent screens
- Thermostats for thermal overload protection
- 1.15 Service Factor (unless otherwise noted)
- UL Recognized and CSA Certified



HP	RPM	VOLTS	FRAME	CAT. NO.	MODEL NO.	STOCK	LIST PRICE	MULT. SYMB.	F.L. AMPS	WEIGHT	"C" DIM.	FOOT NOTES
5	1800	208-230	184TZ	Z124A	184TBDW7369		\$1,388	S1	23.0-21.0	82	16.72	13
7 1/2	1800	208-230	215TZ	Z125	215TBDR7361		\$1,837	S1	35.2	135	19.19	
10	1800	230	215TZ	Z126	215TBDW7362		\$1,939	S1	44.0	158	18.70	
15	1800	230	256TZ	Z127	256TBDX7028		\$2,404	S1	61.0	187	24.06	17

Condenser Fan/Heat Pump, PSC, Open Air Over

Thru-Bolt, Shaft Up or Horizontal

Applications:

Direct drive condenser fans mounted vertically, shaft up. Models with open brackets should be mounted where they are shielded from rain. These motors need to be mounted within the airflow of the fan for proper cooling.

Features:

- Frame and shaft end bracket enclosed, except X011, X012, and X208 have open frames and X426 has open frame and brackets
- Single and multi-speed models as noted
- Ball bearings
- Weather resistant reversing plug
- 30" long leads
- Shaft with flat, unless otherwise noted
- 60°C ambient (as noted)
- Shaft slinger
- 1-5/8" Extended thru-bolts on shaft end, except where noted
- Automatic reset thermal protector
- Lug mount kits and other accessories available, see Accessories section
- UL Recognized and CSA Certified
- Capacitor not included, see Accessories section



X208



X081



X426



X011

HP	RPM	VOLTS	FRAME	CAT. NO.	MODEL NO.	STOCK	LIST PRICE	MULT. SYMB.	F.L. AMPS	WEIGHT	FRAME LENGTH	SHAFT DIM.	FOOT NOTES
1/4	1625/1	208-230	48Y	X012	48A17O2006	✓	\$147	F1	1.8-1.8	12	4 1/2	1/2 x 6	30,34,44
	1625/1	460	48Y	X420	48A17O169	✓	\$197	F1	1.0	12	4	1/2 x 6	34
	1075/2	208-230	48Y	X081	48A11O2031	✓	\$164	F1	1.9-1.9	12	4 1/4	1/2 x 6	
	1075/1	208-230	48Y	X213	48A11O1524	✓	\$140	F1	1.4-1.2	12	4 1/4	1/2 X 6	21
	1075/1	208-230	48Y	X087	48A11O2029	✓	\$133	F1	2.0-2.0	12	4 1/4	1/2 x 6	
	1075/1	460	48Y	X423	48A11O2055	✓	\$152	F1	1.0	13	4 1/4	1/2 x 6	36
1/3	825/1	208-230	48Y	X097	48A8O182	✓	\$197	F1	1.8-1.8	13	4 1/2	1/2 x 6	
	1625/3	208-230	48Y	X011	48A17O2005	✓	\$158	F1	2.3-2.3	14	4 3/4	1/2 x 6	30,34,44
	1075/2	208-230	48Y	X083	48A11O2034	✓	\$174	F1	3.0-3.0	18	4 3/4	1/2 x 6	

Continued on next page.

Condenser Fan/Heat Pump, PSC, Open Air Over

Thru-Bolt, Shaft Up or Horizontal

HP	RPM	VOLTS	FRAME	CAT. NO.	MODEL NO.	STOCK	LIST PRICE	MULT. SYMB.	F.L. AMPS	WEIGHT	FRAME LENGTH	SHAFT DIM.	FOOT NOTES
1/3	1075/1	208-230	48Y	X214	048A11O1525	✓	\$139	F1	2.3-2.6	139	4 1/2	1/2 x 6	45
	1075/1	208-230	48Y	X088	048A11O2032	✓	\$143	F1	3.0-3.0	143	4 3/4	1/2 x 6	
	1075/1	460	48Y	X424	048A11O2054	✓	\$172	F1	1.4	172	4 3/4	1/2 x 6	36
	825/1	208-230	48Y	X086	048A8O2001	✓	\$221	F1	2.4-2.4	221	5 1/4	1/2 x 6	
1/2	1625/1	460	48Y	X422	048A17O172	✓	\$249	F1	1.7	249	5	1/2 x 6	36
	1625/1	575	48Y	X454	048A17O250	✓	\$249	F1	1.35	249	5	1/2 x 6	36
	1075/1	208-230	48Y	X096	048A11O840	✓	\$191	F1	4.2-4.2	191	5 1/2	1/2 x 6	
	1075/1	208-230	48Y	X089	048A11O2035		\$161	F1	4.2-4.2	17	5 1/4	1/2 x 6	45
	1075/1	208-230	48Y	X221	048A11O1526	✓	\$169	F1	2.7-2.6	169	5	1/2 x 6	45
	1075/1	460	48Y	X400	048A11O2017	✓	\$194	F1	1.8	194	5	1/2 x 6	35
	1075/1	575	48Y	X453	048A11O1771	✓	\$194	F1	1.15	194	5	1/2 x 6	35
	825/1	208-230	48Y	X098	048A8O181	✓	\$266	F1	3.3-3.3	266	5 1/2	1/2 x 6	
	825/1	208-230	56Z	X208	056A8O5	✓	\$407	F1	3.4-3.4	407	8 5/8	5/8 x 6 w/key/flat	30
	3/4	1075/2	208-230	48Y	X085	048A11O678	✓	\$221	F1	5.1-5.1	221	5 1/2	1/2 x 6
1075/1		208-230	48Y	X298	048A11O2059	✓	\$185	F1	4.0-4.2	185	5 1/4	1/2 x 6	
1075/1		208-230	48Y	X090	048A11O2007	✓	\$209	F1	4.6-4.6	209	5 1/2	1/2 x 6	
1075/1		460	48Y	X099	048A11O2016	✓	\$223	F1	2.5	223	5 1/2	1/2 x 6	34
1075/1		460	48YZ	X426	048A11O1375	✓	\$270	F1	2.2	270	5 1/2	5/8 x 4.5 w/key	69
1075/1		575	48Y	X455	048A11O1770	✓	\$223	F1	1.7	223	5 1/2	1/2 x 6	35
1		1075/1	200-230/460	56Z	P190	5KCP49Z9617T	✓	\$477	F1	6.7-6.8/3.4	477	9.0	5/8 x 4

Condenser Fan/Heat Pump, PSC, Open Air Over

Thru-Bolt Mount, Shaft Down

Applications:

Direct drive condenser fans mounted vertically, shaft down. These motors need to be mounted within the airflow of the fan for proper cooling.

Features:

- Frame and opposite shaft end bracket are enclosed for vertical shaft down mounting
- Weather resistant reversing plug
- 30" Long leads
- Shaft slinger
- 1-1/4" Extended thru-bolts on shaft end, except where noted
- Automatic reset thermal protector
- Ball Bearings
- UL Recognized and CSA Certified
- Capacitor not included, see Accessories section



HP	RPM	VOLTS	FRAME	CAT. NO.	MODEL NO.	STOCK	LIST PRICE	MULT. SYMB.	F.L. AMPS	WEIGHT	FRAME LENGTH	SHAFT DIM.	FOOT NOTES
1/8	825	208-230	48Y	X278	048A8O206	✓	\$181	F1	0.9-0.9	11	4 1/4	1/2 X 4 3/4	37,44
1/6	1075	208-230	48Y	X440	048A11O2065	✓	\$119	F1	1.0-0.9	10	4	1/2 X 6	
1/5	1075	208-230	48Y	X216	048A11O1097	✓	\$133	F1	1.8-1.6	10	3 3/4	1/2 X 6	37,44,60
1/4	1075	208-230	48Y	X441	048A11O2062	✓	\$146	F1	1.35-1.35	12	4 1/4	1/2 X 6	
1/3	1075	208-230	48Y	X442	048A11O2064	✓	\$156	F1	2.0-1.95	14	4 3/4	1/2 X 6	
	1075	208-230	48Y	X297	048A11T509	✓	\$141	F1	1.8-1.8	12	4 1/4	1/2 X 3 3/4	N,29,41,60
1/2	1075	208-230	48Y	X443	048A11O2063	✓	\$173	F1	3.9-3.9	18	5 1/4	1/2 X 6	
3/4	1075	208-230	48Y	X444	048A11O1596	✓	\$230	F1	4.3-4.7	18	5 1/2	1/2 X 6	

Condenser Fan/Heat Pump, PSC, Air Over

48 Frame, Thru-Bolt, All-Angle

Applications:

Direct drive condenser fans for all angle mounting. These motors need to be mounted within the airflow of the fan for proper cooling.

Features:

- Frame and end brackets enclosed
- Single and multi-speed models, as noted
- Ball bearings (except as noted)
- Weather resistant reversing plug
- 30" long leads
- Shaft slinger
- 1-1/2" Thru-bolts on shaft end, 1" thru-bolts on lead end (except as noted)
- Automatic reset thermal protector
- Weep holes with removable plugs on end brackets. Remove bottom plug after installation.
- Lug mount kits and other accessories available (see Accessories section)
- 60°C ambient, as noted
- UL Recognized and CSA Certified
- Capacitor not included, see Accessories section



HP	RPM	VOLTS	FRAME	CAT. NO.	MODEL NO.	STOCK	LIST PRICE	MULT. SYMB.	F.L. AMPS	WEIGHT	FRAME LENGTH	SHAFT DIM.	FOOT NOTES
1/6	1075/2	208-230	48Y	X429	048A11T2020	✓	\$160	F1	1.3-1.3	11	4	1/2 x 6	36
	1075/1	208-230	48Y	X411	048A11T2008	✓	\$152	F1	1.3-1.3	10	3 3/4	1/2 x 6	
	1075/1	208-230	48Y	X427	048A11T2017		\$152	F1	1.3-1.3	10	3 3/4	1/2 x 6	
1/4	825/1	208-230	48Y	X465	048A8T11002	✓	\$160	F1	1.1-1.1	12	4 1/4	1/2 x 6	45
	1625/1	208-230	48Y	X467	048A47T87	✓	\$143	F1	2.0-2.0	12	4 1/2	1/2 x 6	21,36
	1625/2	208-230	48Y	X463	048A17T356	✓	\$164	F1	1.4-1.4	13	4 1/2	1/2 x 6	45,94
1/3	1075/2	208-230	48Y	X430	048A11T463	✓	\$174	F1	1.8-1.8	16	4 1/2	1/2 x 6	36
	1075/1	208-230	48Y	X412	048A11T569	✓	\$169	F1	1.4-1.4	16	4 1/4	1/2 x 6	45
	1075/1	460	48Y	X456	048A11T578	✓	\$174	F1	0.75	15	4 1/2	1/2 x 6	45
	840/1	208-230	48Y	X450	048A8T71	✓	\$164	F1	1.9-1.9	17	5 1/4	1/2 x 6	45
	1625/1	208-230	48Y	X466	048A17T86	✓	\$157	F1	2.0-2.0	15	5	1/2 x 6	21,36
1/2	1075/2	208-230	48Y	X415	048A11T2012	✓	\$186	F1	2.6-2.6	16	5	1/2 x 6	36
	1075/1	208-230	48Y	X413	048A11T529	✓	\$183	F1	1.9-1.9	14	4 3/4	1/2 x 6	45
	1075/1	460	48Y	X457	048A11T579	✓	\$185	F1	0.9	17	5	1/2 x 6	36,45
	825/1	208-230	48Y	X451	048A8T72	✓	\$173	F1	2.3-2.3	19	5 3/4	1/2 x 6	34,45
	1625/1	208-230	48Y	X468	048A17T96	✓	\$177	F1	2.9-2.6	16	5 1/4	1/2 x 6	21
	1625/2	208-230	48Y	X464	048A17T359	✓	\$199	F1	3.1-2.9	17	5 1/4	1/2 x 6	45
	1075/2	208-230	48Y	X416	048A11T2013	✓	\$204	F1	4.2-4.2	19	5 1/2	1/2 x 6	36
3/4	1075/1	208-230	48Y	X414	048A11T571	✓	\$201	F1	2.7-2.7	17	5	1/2 x 6	36,45
	1075/1	460	48Y	X458	048A11T580	✓	\$204	F1	1.4	20	5 1/2	1/2 x 6	36,45
	825/1	208-230	48Y	X452	048A8T73	✓	\$213	F1	3.1	21	6 1/4	1/2 x 6	45
	1075/1	208-230	48Y	X469	048A11T276	✓	\$177	F1	4.2-3.65	21	6	1/2 x 6	21,63
1	1075/1	460	48Y	X459	048A11T581	✓	\$230	F1	2.1	23	6	1/2 x 6	32,45
	1075/1	460	48Y	X462	048A11T619	✓	\$272	F1	3.4	27	7 1/4	1/2 x 6	32,45

Condenser Fan/Heat Pump, PSC, Open Air Over

Rigid Base, Shaft Up or Horizontal

Applications:

Condenser fans, installed outdoors. These motors need to be mounted within the airflow of the fan for proper cooling.

Features:

- Frame and shaft end bracket enclosed
- Heavy gauge steel constructions
- 56Y frame has non-NEMA BA dimension of 1.97"
- Automatic reset thermal protector
- Flat and keyway on shaft
- Ball Bearings
- UL Recognized and CSA Certified
- Capacitor included on X432, see Accessories section to order capacitor for X433



HP	RPM	VOLTS	FRAME	CAT. NO.	MODEL NO.	STOCK	LIST PRICE	MULT. SYMB.	F.L. AMPS	WEIGHT	FRAME LENGTH	SHAFT DIM.	FOOT NOTES
3/4	1075	208-230/460	56YZ	X432	056A11O29	✓	\$334	F1	4.6-4.4/2.2	22	11.88	5/8 x 4 1/2	36
1	1075	208-230/460	56YZ	X433	056S11O30	✓	\$398	F1	5.8-5.4/2.7	27	12.38	5/8 x 4 1/2	

Condenser Fan/Heat Pump, Single Phase, PSC

56 Frame, Resilient Ring, Thru-Bolt

Applications:

Direct drive condenser fans mounted vertically, shaft up or horizontal. These motors need to be mounted within the airflow of the fan for proper cooling.



Features:

- Enclosed shaft end bracket with vented frame
- Ball bearings
- 30" long leads (except P243)
- Shaft slinger
- 60°C ambient, as noted
- Automatic reset thermal protector
- Flat & keyway on shaft
- UL Recognized and CSA Certified
- Capacitor not included, see Accessories section

Open Air Over, Shaft Up

HP	RPM	VOLTS	FRAME	CAT. NO.	MODEL NO.	STOCK	LIST PRICE	MULT. SYMB.	F.L. AMPS	WEIGHT	FRAME LENGTH	SHAFT DIM.	FOOT NOTES
3/4	1075	208-230/460	56Y	X207	056A11O5311	✓	\$377	F1	3.9-3.6/1.8	31	8 1/4	5/8 x 6	37,45
1	1075	208-230/460	56Y	X206	056A1105310	✓	\$398	F1	5.4-5.2/2.6	34	10 1/16	5/8 x 6	37
1 1/2	1075	208-230/460	56Y	X271	056A11O5305	✓	\$454	F1	7.7-7.6/3.8	43	9 3/4	5/8 x 6	34,45

Dripproof

HP	RPM	VOLTS	FRAME	CAT. NO.	MODEL NO.	STOCK	LIST PRICE	MULT. SYMB.	F.L. AMPS	WEIGHT	FRAME LENGTH	SHAFT DIM.	FOOT NOTES
1/2	825/1	115/208-230	56Y	P245	5KCP49PN9812S	✓	\$513	F1	6.2/3.8-3.1	31	13.66	5/8 X 6	
3/4	1075/1	208-230/460	56Y	P243	5KCP49RN9611S	✓	\$486	F1	4.9-3.8/1.9	33	13.66	5/8 X 6	
	825/1	208-230	56Y	P246	5KCP49UN9811S	✓	\$556	F1	5.8-5.6	32	14.47	5/8 X 6	
1	1075/3	115	56Y	P184	5KCP49UN9612S	✓	\$532	F1	10.8	40	14.87	5/8 x 6	
	1075/3	200-230	56Y	P185	5KCP49UN9614S	✓	\$532	F1	4.8-5.0	34	14.87	5/8 X 6	
	1075/1	208-230/460	56Y	P244	5KCP49UN9613S	✓	\$511	F1	6.3-5.0/2.5	40	14.47	5/8 X 6	
	825/1	208-230/460	56Y	P180	5KCP49WN9813S	✓	\$586	F1	6.3-6.4/3.2	39	11.24	5/8 x 6	

Commercial Condenser Fan/Heat Pump, PSC

Open Air Over, Belly Band, Shaft Up

Applications:

Heavy duty design for commercial direct drive condenser fans mounted vertically, shaft up. These motors need to be mounted within the airflow of the fan for proper cooling.

Features:

- Open frame and end brackets
- Shaft with flat, unless otherwise noted
- Unique Rain Shield fits over shaft to protect motor in vertical shaft up position
- Shaft slinger
- Automatic reset thermal protector
- 60°C ambient (as noted)
- Ball bearings
- UL Recognized and CSA Certified
- Capacitor not included, see Accessories section



HP	RPM	VOLTS	FRAME	CAT. NO.	MODEL NO.	STOCK	LIST PRICE	MULT. SYMB.	F.L. AMPS	WEIGHT	FRAME LENGTH	SHAFT DIM.	FOOT NOTES
0.4	1075	200-230/460	48Y	X445	048A11O1732		\$204	F1	3.0-2.8/1.4	29	5 1/2	1/2 x 4	
0.6	1075	200-230/460	48Y	X446	048A11O1643	✓	\$225	F1	3.0-3.6/1.8	20	6 7/8	1/2 x 4	
0.8	1075	200-230/460	48Y	P193	5KCP39SNB480S		\$252	F1	4.0/2.0	21	14 1/5	1/2 x2 3/4	
	1075	200-230/460	48Y	P194	5KCP39SNB481S		\$301	F1	4.0/2.0	21	9 1/3	5/8 x 4 7/8	
	1075	200-230/460	48Y	X447	048A11O1642	✓	\$301	F1	5.0-4.4/2.2	27	8 3/4	1/2 x 4	45
1	1075	200-230/460	48Y	P195	5KCP39SNB482S	✓	\$325	F1	5.6/2.8	21	10 5/8	5/8 x 5 1/4 w/key/flat	
	1075	200-230/460	56Y	X448	056A11O5314	✓	\$325	F1	6.0-5.2/2.6	33	8 3/4	5/8 x 4 w/key/flat	45
	1075	575	56Y	P196	5KCP39TNB763T	✓	\$325	F1	2.6	22	10 1/4	1/2 x 5 1/4	
1.5	1075	200-230/460	56Y	P197	5KCP39UNB767T	✓	\$373	F1	8.1-7.8/3.9	23	10 1/4	5/8 spcl.	d
	1075	200-230/460	56Y	X449	056A11O5315		\$373	F1	7.0-7.0/3.5	39	9 1/4	5/8 x 4	45
	1075	575	56Y	P198	5KCP39UNB764T	✓	\$373	F1	3.5	23	10 1/4	1/2 x 5 1/4	

Commercial Condenser Fan/Heat Pump, PSC

Resilient Base, Shaft Up or Horizontal

Applications:

Condenser fans, installed outdoors. These motors need to be mounted within the airflow of the fan for proper cooling.

Features:

- Frame and shaft end bracket enclosed
- Automatic reset thermal protector
- Ball bearings
- UL Recognized and CSA Certified
- Capacitor included



HP	RPM	VOLTS	FRAME	CAT. NO.	MODEL NO.	STOCK	LIST PRICE	MULT. SYMB.	F.L. AMPS	WEIGHT	FRAME LENGTH	SHAFT DIM.	FOOT NOTES
1/2	1075	208-230/460	48YZ	X431	048A11O1461	✓	\$263	F1	3.0-3.0/1.5	19	11.94	1/2 x 4 1/2	

Commercial Condenser Fan/Heat Pump, Three Phase

Open Air Over, Rigid Base, Shaft Up or Horizontal

Applications:

Commercial condenser fans may be installed outdoors. These motors need to be mounted within the airflow of the fan for proper cooling. Used on Trane, Carrier, Climtrol and York units, 5 tons and larger.

Features:

- 70°C ambient (except as noted)
- Enclosed shaft end bracket, vented frame
- Continuous duty, air over
- Automatic reset thermal protector
- Shaft slinger
- Threaded lead exit
- Nameplated 60/50 hertz 190/380 volts, at next lower HP
- Double sealed ball bearings
- Flat and keyway on shaft
- Patented VCD™ - Voltage Change Device (as noted)
- Ball Bearings
- UL Recognized and CSA Certified



As Noted

HP	RPM	VOLTS	FRAME	CAT. NO.	MODEL NO.	STOCK	LIST PRICE	MULT. SYMB.	F.L. AMPS	WEIGHT	FRAME LENGTH	SHAFT DIM.	FOOT NOTES
1/3	1140	208-230/460	56Z	X532	056T11O11001	✓	\$355	F1	1.8-1.8/0.9	22	13.37	1/2 x 5	45,50
1/2	1140	208-230/460	56Z	X533	056T11O11002	✓	\$382	F1	2.1-2.0/1.0	20	13.37	5/8 x 5	45,50
	850	208-230/460	56HZ	X529	056T8O5531	✓	\$547	F1	2.9-3.0/1.5	31	14.68	5/8 x 5	VC,5
3/4	1140	208-230/460	56HZ	X512	056T11O15511		\$425	F1	2.7-3.0/1.5	27	14.18	5/8 x 5	VC,5
1	1140	208-230/460	56HZ	K1485	5K49RN6118S		\$435	F1	4.2-4.0/2.0	33	16.02	5/8 X 6	46
	1140	208-230/460	56HZ	X513	056T11O5305	✓	\$461	F1	4.1-4.2/2.1	29	14.68	5/8 x 5	VC,5
	850	208-230/460	56HZ	X528	056T8O5306	✓	\$614	F1	5.1-5.3/2.65	49	17.06	5/8 x 5	VC,5
1 1/2	1140	208-230/460	56HZ	K1486	5K48TN6119S		\$473	F1	5.1-5.0/2.5	38	16.77	5/8 X 6	46
	1140	208-230/460	56HZ	X523	056T11O5306	✓	\$501	F1	5.45-5.4/2.7	36	15.68	5/8 x 5	VC,5
	850	208-230/460	56HZ	X531	056T8O15504	✓	\$668	F1	7.0-7.0/3.5	47	16.68	5/8 x 5	VC,5
2	1140	208-230/460	56HZ	X525	056T11O5310	✓	\$543	F1	7.2-6.8/3.4	47	16.68	5/8 x 5	VC,5

Condenser Fan/Heat Pump, Three Phase

Open Air Over, Belly Band/Resilient Ring

Applications:

Commercial condenser fans may be installed outdoors. These motors need to be mounted within the airflow of the fan for proper cooling. Used on Trane, Carrier, Climatrol and York units, 5 tons and larger.

Features:

- 70°C ambient (except as noted)
- Enclosed shaft end bracket, vented frame
- Automatic reset thermal protector
- Nameplate 60/50 hertz 190/380 volts, at next lower HP (except as noted)
- Double sealed ball bearings
- 5/8" Dia. x 5" long shaft with flat and keyway
- Ball bearings
- Threaded lead exit
- Patented VCD™ - Voltage Change Device
- 4 Locating screws 90 degrees apart, 3.33" from outer edge of shaft slinger
- Hubs on both ends will accept resilient base kits, see Accessories section (except X524 and X526 - horizontal only)
- UL Recognized and CSA Certified
- External shaft slinger on all, internal slinger on 5K models



HP	RPM	VOLTS	FRAME	CAT. NO.	MODEL NO.	STOCK	LIST PRICE	MULT. SYMB.	F.L. AMPS	WEIGHT	FRAME LENGTH	FOOT NOTES
1/3	850	208-230/460	56Y	X511	056T8O5303	✓	\$493	F1	2.3-2.5/1.25	23	9 1/2	VC
1/2	1140	200-230/460	56Y	X500	056T11O5300	✓	\$392	F1	2.4-2.7/1.35	21	9.00	VC
	1140	575	56Y	K1500	5K49MN6432S	✓	\$467	F1	1.0	27	9.49	33,46
3/4	1140	208-230/460	56Y	K378	5K46LN6033S		\$410	F1	3.0-3.4/1.7	25	8.89	46
	1140	200-230/460	56Y	X501	056T11O5301	✓	\$434	F1	3.1-3.2/1.6	24	9.50	VC
	1140	575	56Y	K1505	5K46LN6428S	✓	\$490	F1	1.5	25	8.89	33,46
	850	208-230/460	56Y	X506	056T8O5301		\$574	F1	3.6-3.6/1.8	39	11.00	VC
1	1140	208-230/460	56Y	K379	5K49RN6034S		\$429	F1	4.2-4.0/2.0	33	10.02	46
	1140	200-230/460	56Y	X502	056T11O5302	✓	\$455	F1	4.0-4.2/2.1	28	10.00	VC
	1140	575	56Y	X522	056T11O5308	✓	\$427	F1	1.7	28	10.00	70
	1140	575	56Y	K1510	5K49RN6429S		\$427	F1	1.6	33	16.02	33,46
	850	208-230/460	56Y	K1482	5K48WN3013S		\$563	F1	5.1-5.2/2.6	44	10.77	46
	850	200-230/460	56Y	X507	056T8O5302	✓	\$597	F1	5.3-5.3/2.6	46	12.00	VC
	850	575	56Y	K1511	5K48WN3181S	✓	\$563	F1	2.0	44	10.77	d,33,46
	850	575	56Y	X527	056T8O5304	✓	\$597	F1	2.1	46	12.00	70
1 1/2	1140	200-230/460	56Y	X503	056T11O5303	✓	\$497	F1	5.5-5.4/2.7	35	11.00	VC
	1140	575	56Y	X524	056T11O5307	✓	\$497	F1	2.2	35	11.00	73
	1140	575	56Y	K1515	5K48TN6430S		\$467	F1	2.2	38	10.77	33,46
	850	208-230/460	56Y	X530	056T8O5307	✓	\$643	F1	7.5-6.8/3.4	47	11.25	VC
2	1140	208-230/460	56Y	X509	056T11O5304	✓	\$539	F1	7.2-6.8/3.4	49	12.00	VC
	1140	575	56Y	K1520	5K49ZN6433S	✓	\$497	F1	2.5	49	11.97	d,33,46
	1140	575	56Y	X526	056T11O5309	✓	\$539	F1	2.7	45	11.63	73

Shaft Up with Fan Canopy / Rainshield

HP	RPM	VOLTS	FRAME	CAT. NO.	MODEL NO.	STOCK	LIST PRICE	MULT. SYMB.	F.L. AMPS	WEIGHT	FRAME LENGTH	FOOT NOTES
1/2	1140	200-230/460	48Y	K1403	5K36PN345S	✓	\$465	F1	2.2-2.6/1.3	20	7.95	46
3/4	1140	200-230/460	48Y	K1404	5K38SN267S	✓	\$489	F1	3.3-3.8/1.9	24	8.95	46
	1140	575	48Y	K1405	5K39SNB765T	✓	\$519	F1	1.5	21	8.50	46
1	1140	200-230/460	48Y	K1402	5K39SNB505S	✓	\$539	F1	4.4-4.0/2.0	21	8.50	46
1 1/2	1140	200-230/460	48Y	K1407	5K39SNB587S	✓	\$590	F1	6.0-5.8/2.9	21	10.63	46

Fan and Blower - Direct Drive, PSC Open Air Over, Resilient Ring, Thru-Bolt Mount

Features:

- Open frames and brackets (except X011 and X012 have enclosed shaft end bracket)
- Single and multi-speed models as noted
- Grommeted lead exit
- Weather resistant reversing plug
- 2-1/4" resilient ring mounting except where noted (base not included, see Accessories section)
- 2 1/2" adapter rings supplied, shipped loose in box
- Extended thru-bolts on shaft end
- 30" long leads
- Automatic reset thermal protector
- Ball bearings
- UL Recognized and CSA Certified
- Capacitor not included, see Accessories section



X001



X211



X242



X219



X033

HP	RPM	VOLTS	FRAME	CAT. NO.	MODEL NO.	STOCK	LIST PRICE	MULT. SYMB.	F.L. AMPS	WEIGHT	FRAME LENGTH	SHAFT DIM.	FOOT NOTES
1/5	1075/3	115	48Y	X219	048A11O2047	✓	\$132	F1	3.5	11	4	1/2 x 4	39
1/4	1625/3	115	48Y	X013	048A17O152	✓	\$145	F1	2.9	12	5	1/2 x 4	32
	1625/3	208-230	48Y	X014	048A17O154	✓	\$147	F1	1.8-1.35	11	4 1/4	1/2 x 4	32
	1625/1	208-230	48Y	X012	048A17O2006	✓	\$147	F1	1.8-1.8	12	4 1/2	1/2 x 6	34,44
	1075/3	115	48Y	X000	048A11O1798	✓	\$139	F1	3.4	12	4 1/4	1/2 x 4	32
	1075/3	208-230	48Y	X001	048A11O1799	✓	\$143	F1	1.5-1.5	12	4 1/2	1/2 x 4	32
	1075/3	277	48Y	X018	048A11O1350	✓	\$149	F1	1.6	11	4 1/4	1/2 x 4	32
	1075/1	208-230	48Y	X006	048A11O2001	✓	\$137	F1	2.0-2.0	11	4 1/4	1/2 x 4	32
	1075/1	208-230	48Y	X417	048A11O2051	✓	\$146	F1	2.0-2.2	13	4 1/4	1/2 x 6	51,116
1/3	1625/3	115	48Y	X015	048A17O151	✓	\$154	F1	4.0	13	4 3/4	1/2 x 4	32
	1625/3	208-230	48Y	X011	048A17O2005	✓	\$158	F1	2.3-2.3	14	4 3/4	1/2 x 6	34,44
	1075/4	115	48Y	X236	048A11O699	✓	\$173	F1	6.4	16	4 3/4	1/2 x 6	39
	1075/4	208-230	48Y	X237	048A11O694		\$176	F1	4.8-4.8	16	5 1/4	1/2 x 6	39
	1075/3	115	48Y	X002	048A11O1769	✓	\$149	F1	4.6	14	4 3/4	1/2 x 4	32
	1075/3	208-230	48Y	X003	048A11OB2042	✓	\$152	F1	3.3-3.3	14	4 3/4	1/2 x 4	32
	1075/3	277	48Y	X019	048A11O1351	✓	\$159	F1	2.7	15	4 3/4	1/2 x 4	32
	1075/2	460	48Y	X037	048A11O1876	✓	\$299	F1	1.0	14	4 3/4	1/2 x 6	51
	1075/1	208-230	48Y	X418	048A11O2052	✓	\$155	F1	3.1-3.1	14	4 1/2	1/2 x 6	51,116
	825/1	230	48Y	X209	048A8O183	✓	\$190	F1	2.8	17	5 3/4	1/2 x 5 1/2	34,43
1/2	1625/3	115	48Y	X016	048A17O153	✓	\$172	F1	5.0	16	5 1/4	1/2 x 4	32
	1625/3	208-230	48Y	X017	048A17O155	✓	\$174	F1	4.1-4.1	16	5 1/4	1/2 x 4	32
	1075/4	115	48Y	X033	048A11O1674	✓	\$145	F1	6.1	15	5	1/2 x 5	31,73
	1075/3	115	48Y	X004	048A11O1755	✓	\$168	F1	6.2	17	5 1/2	1/2 x 4	32
	1075/3	208-230	48Y	X005	048A11O1756	✓	\$170	F1	2.65-2.6	17	5 1/2	1/2 x 4	32
	1075/3	277	48Y	X020	048A11O1352	✓	\$177	F1	3.6	17	5 1/2	1/2 x 4	32
	1075/1	208-230	48Y	X419	048A11O2053		\$173	F1	4.2	17	5 1/4	1/2 x 6	51,116
3/4	1625/3	230	48Y	X022	048A17O174	✓	\$191	F1	3.7	18	5 1/2	1/2 x 5 1/2	39,43
	1075/4	208-230	48Y	X241	048A11O697	✓	\$223	F1	5.4-5.4	17	5 1/2	1/2 x 6	39
	1075/3	115	48Y	X009	048A11O787	✓	\$196	F1	10.2	20	5 3/4	1/2 x 4	32
	1075/3	208-230	48Y	X010	048A11O2046	✓	\$199	F1	5.6	19	5 1/2	1/2 x 4	32
	1075/3	277	48Y	X021	048A11O1353	✓	\$204	F1	5.0	20	5 3/4	1/2 x 4	32
1	1625/2	208-230	48Y	X211	048A17O125	✓	\$248	F1	6.2	20	6 1/4	1/2 x 2 1/2	39,42,43
	1075/3	230	48Y	X023	048A11O1583	✓	\$227	F1	5.3	24	6 1/2	1/2 x 5	34
	1075/3	208-230	48YZ	X242	048A11O756	✓	\$377	F1	6.2	26	7 1/4	5/8 x 4	39,51

Fan and Blower - Direct Drive, PSC Open Air Over, Resilient Ring

Applications:

Single speed PSC motors designed to replace PSC and Shaded pole motors, used in direct drive furnace, air conditioners, and others blowers.

Features:

- Open frame and brackets
- Heavy gauge steel frame and base
- Shaft with flat
- 70°C ambient
- 37" Leads
- Thermal overload protection
- 1/4" terminals on the capacitor leads
- 2 1/4" resilient rings, includes 2 1/2" expanders
- Capacitor not included, see Accessories section



HP	RPM	VOLTS	FRAME	CAT. NO.	MODEL NO.	STOCK	LIST PRICE	MULT. SYMB.	F.L. AMPS	WEIGHT	FRAME LENGTH	SHAFT DIM.	FOOT NOTES
1/6	1625	115	48Y	X477	48A17O128	✓	\$138	F1	2.6	9	4	1/2 x 4	
	1625	230	48Y	X475	48A17O123	✓	\$138	F1	1.3	9	4	1/2 x 4	
	1075	115	48Y	X473	48A11O1046	✓	\$133	F1	2.9	9	4	1/2 x 4	
	1075	230	48Y	X471	48A11O1044	✓	\$133	F1	1.3	10	4	1/2 x 4	
1/4	1625	230	48Y	X476	48A17O124	✓	\$147	F1	1.8	10	4 1/4	1/2 x 4	
	1075	115	48Y	X472	48A11O1045	✓	\$139	F1	4.0	11	4 1/4	1/2 x 4	
	1075	230	48Y	X474	48A11O1047	✓	\$139	F1	2.0	11	4 1/4	1/2 x 4	

Fan and Blower - Direct Drive, PSC Open Air Over, Torsion Flex Mount

Applications:

Residential and commercial furnaces, air conditioners, exhaust fans, and other air handling equipment installed in clean and dry environments.

Features:

- Open frames and brackets
- Three lug mount fits 9" or 10" bolt circle. Mounting holes on lugs are .435" dia., with gromets and sleeves for .26" dia. option.
- Multi-speed capacity
- Weather resistant reversing plug
- 30" long leads
- Automatic reset thermal protector
- Ball Bearings
- UL Recognized and CSA Certified
- Capacitor not included, see Accessories section



HP	RPM	VOLTS	FRAME	CAT. NO.	MODEL NO.	STOCK	LIST PRICE	MULT. SYMB.	F.L. AMPS	WEIGHT	FRAME LENGTH	SHAFT DIM.	FOOT NOTES
1/4	1075/4	115	48Y	X034	48A11O1773	✓	\$160	F1	3.3	14	4 1/2	1/2 x 6	
1/3	1075/4	115	48Y	X035	48A11O1774	✓	\$172	F1	4.5	15	4 1/2	1/2 x 6	
1/2	1075/4	115	48Y	X036	48A11O1772	✓	\$190	F1	6.0	19	5	1/2 x 6	

Fan & Blower - Direct Drive, PSC Open Air Over, Extended Thru-Bolt, 460 Volt

Applications:

Residential and commercial furnaces, air conditioners, exhaust fans, and other air handling equipment installed in clean and dry environments.

Features:

- Enclosed frame and open end brackets
- Multi-speed capability
- Grommeted lead exit
- Weather resistant reversing plug
- Automatic reset thermal protector
- 7/8" extended thru-bolts on shaft end
- Ball Bearings
- UL Recognized and CSA Certified
- Capacitor not included, see Accessories section



HP	RPM	VOLTS	FRAME	CAT. NO.	MODEL NO.	STOCK	LIST PRICE	MULT. SYMB.	F.L. AMPS	WEIGHT	FRAME LENGTH	SHAFT DIM.	FOOT NOTES
1/3	1075/2	460	48Y	X037	48A11O1876	✓	\$299	F1	1.0	14	4 3/4	1/2 X 6	51
1/2	1075/2	460	48Y	X038	48A11O1874	✓	\$305	F1	1.6	17	5 1/4	1/2 X 6	51
3/4	1075/2	460	48Y	X039	48A11O1875	✓	\$311	F1	2.1	19	5 1/2	1/2 X 6	51

Fan and Blower - Direct Drive, PSC, Open Air Over Belly Band Thru-Bolt, Double Shaft

Applications:

Continuous air over applications, such as room air conditioners, fan coil units, and other air moving applications.

Features:

- Open frame and brackets
- Multi-speed capability
- Automatic reset thermal protector
- 30" leads
- CCW rotation, fixed lead end
- 1" extended Thru-bolts both ends
- 20" overall length
- Length adapter kits included where noted
- Ball bearings
- UL Recognized and CSA Certified
- Capacitor not included, see Accessories section



HP	RPM	VOLTS	FRAME	CAT. NO.	MODEL NO.	STOCK	LIST PRICE	MULT. SYMB.	F.L. AMPS	WEIGHT	FRAME LENGTH	SHAFT DIM.	FOOT NOTES
1/8	1075/3	115	48Y	X064	048A11O2011		\$132	F1	2.4	11	4	8 1/5 x 1/2 x 7 7/8	
	1075/3	115	48Y	X056	048A11O901	✓	\$146	F1	2.4	13	4	8 1/5 x 1/2 x 7 7/8	71
	1075/3	208-230	48Y	X065	048A11O2012	✓	\$132	F1	1.0	11	4	8 1/5 x 1/2 x 7 7/8	
	1075/3	208-230	48Y	X057	048A11O900		\$146	F1	1.0	33	4	8 1/5 x 1/2 x 7 7/8	71
1/6	1075/3	115	48Y	X048	048A11O772		\$133	F1	3.0	14	4	8 1/5 x 1/2 x 7 7/8	
	1075/3	115	48Y	X042	048A11O653	✓	\$149	F1	3.0	11	4	8 1/5 x 1/2 x 7 7/8	71
	1075/3	208-230	48Y	X049	048A11O773	✓	\$133	F1	1.5	9	4	8 1/5 x 1/2 x 7 7/8	
	1075/3	208-230	48Y	X043	048A11O654	✓	\$149	F1	1.5	11	4	8 1/5 x 1/2 x 7 7/8	71
1/4	1625/3	208-230	48Y	X059	048A17O2002		\$147	F1	1.8	12	4 1/4	8 x 1/2 x 7 7/8	
	1625/3	208-230	48Y	X040	048A17O69	✓	\$163	F1	1.8	12	4 1/4	8 x 1/2 x 7 7/8	71
	1075/3	115	48Y	X061	048A11O2022	✓	\$159	F1	4.8	14	4 1/4	8 x 1/2 x 7 7/8	71
	1075/3	115	48Y	X066	048A11O2013		\$137	F1	4.2	15	4 1/2	7 1/5 x 1/2 x 7 1/3	
	1075/3	208-230	48Y	X050	048A11O774	✓	\$143	F1	2.2	13	4 1/4	8 x 1/2 x 7 7/8	
	1075/3	208-230	48Y	X044	048A11O655	✓	\$159	F1	2.2	16	4 1/4	8 x 1/2 x 7 7/8	71
1/3	1625/3	208-230	48Y	X060	048A17O2003		\$158	F1	2.5	14	4 3/4	7 1/2 x 1/2 x 7 7/8	
	1625/3	208-230	48Y	X041	048A17O70	✓	\$172	F1	2.5	15	4 3/4	7 1/2 x 1/2 x 7 7/8	71
	1075/3	115	48Y	X070	048A11O2024	✓	\$168	F1	7.8	15	4 3/4	7 1/2 x 1/2 x 7 7/8	71
	1075/3	208-230	48Y	X052	048A11O775	✓	\$152	F1	3.4	16	4 3/4	7 1/2 x 1/2 x 7 7/8	
	1075/3	208-230	48Y	X045	048A11O656	✓	\$168	F1	3.4	17	4 3/4	7 1/2 x 1/2 x 7 7/8	71
	1075/3	208-230	48Y	X258	048A11O1167	✓	\$147	F1	2.3	14	4 1/4	6 7/8 x 1/2 x 6 7/8	
1/2	1625/3	208-230	48Y	X058	048A17O2001	✓	\$194	F1	4.1	18	5 1/4	7 x 1/2 x 7 7/8	71
	1625/3	208-230	48Y	X069	048A17O2004		\$177	F1	4.1	16	5 1/4	7 x 1/2 x 7 7/8	
	1075/3	115	48Y	X071	048A11O2026	✓	\$189	F1	9.4	20	5 1/2	6 5/8 x 1/2 x 7 7/8	71
	1075/3	208-230	48Y	X062	048A11O2009	✓	\$189	F1	4.7	17	5 1/2	6 5/8 x 1/2 x 7 7/8	71
	1075/3	208-230	48Y	X067	048A11O2014	✓	\$173	F1	4.7	19	5 1/2	6 5/8 x 1/2 x 7 7/8	
3/4	1075/3	208-230	48Y	X068	048A11O2015		\$197	F1	5.0	15	5 3/4	6 3/4 x 1/2 x 6 7/8	
	1075/3	208-230	48Y	X063	048A11O2028	✓	\$212	F1	5.4	19	5 1/2	6 5/8 x 1/2 x 7 7/8	71

Fan and Blower, Split Phase, Dripproof Resilient Base (Single & Two-Speed)



Features:

- Ball bearings (except as noted)
- Service factor, as noted
- Thermal protection, as noted
- Variable torque on two speed motors
- Extended thru-bolts, as noted
- Heavy gauge steel frame and base
- 48Y and 48YZ frame have 48/56 frame mounting holes
- UL Recognized and CSA certified

HP	RPM	VOLTS	FRAME	OVER LOAD	CAT. NO.	MODEL NO.	STOCK	LIST PRICE	MULT. SYMB.	F.L. AMPS	WEIGHT	"C" DIM.	FOOT NOTES
1/12	1140	115	48Z	AUTO	HG152	5KH32GN140X	✓	\$247	F1	2.4	15	9.32	8,112
1/8	1140	115	48Z	AUTO	HG154	5KH36KN113X	✓	\$273	F1	3.8	17	10.38	8,112
	850	115	56	AUTO	HG155	5KH46MN3021X	✓	\$439	F1	4.6	32	10.88	112
1/6	1725/1140	115	48Z	NONE	H169	5KH36KN114	✓	\$170	F1	3.4/1.9	17	10.38	8,20,54
	1725/1140	115	48Z	AUTO	H170	5KH36KN114X	✓	\$177	F1	3.4/1.9	17	10.38	8,20,54
	1725/1140	115	48	NONE	4322	5KH39QN9548	✓	\$204	F1	3.4/1.9	15	10.00	20
	1725/1140	115	48	AUTO	4389	5KH39QN9548X	✓	\$217	F1	3.4/1.9	18	10.00	20
	1725	115	48Y	AUTO	D107	48S17D2017	✓	\$151	F1	3.6	12	8.99	CF,20
	1725	115	48	NONE	4304	5KH39QN5543	✓	\$146	F1	3.9	12	8.93	20
	1725	115	48Z	AUTO	H913	5KH32DNA700X	✓	\$155	F1	4.4	12	9.74	9,20,28
	1725	115	48Z	NONE	HG156	5KH32DN3085	✓	\$143	F1	3.9	12	9.32	8,20
	1725	115	48Z	NONE	H912	5KH32DNA700	✓	\$105	F1	4.4	12	9.74	9,20,28
	1725	115	48YZ	NONE	B300	48S17D2052	✓	\$145	F1	3.6	13	9.32	CF,20,31,52
	1725	115	48Z	AUTO	H157	5KH32DN3085X	✓	\$151	F1	3.9	12	9.32	8,20
	1725	115	48YZ	AUTO	B322	48S17D2053	✓	\$153	F1	3.6	13	9.32	CF,20,31,52
	1725	115	56Z	AUTO	4350	5KH39QN5538X	✓	\$154	F1	3.9	13	9.19	8,20,26
	1140	115	48	NONE	H112	5KH37PN39	✓	\$242	F1	4	20	10.40	20
	1140	115	48Z	AUTO	H159	5KH37PN41X	✓	\$300	F1	4	21	10.78	8,20
	1140	115	48	NONE	HG695	5KH37PNA233	✓	\$244	F1	4	24	10.40	20
	1140	115	48Z	NONE	H158	5KH37PN41	✓	\$293	F1	4	21	10.78	8,20
	1140	115	48	AUTO	HG113	5KH37PN39X	✓	\$250	F1	4	20	10.40	20
	850	115	56	NONE	H620	5KH49PN3043	✓	\$487	F1	6.1	31	11.48	20
1/4	1725/1140	115	48Y	AUTO	D180	48S17D7204	✓	\$185	F1	4.1/2.5	18	10.06	20
	1725/1140	115	48Z	AUTO	H172	5KH37PN33X	✓	\$203	F1	4.2/2.7	21	10.69	8,20,54
	1725/1140	115	48Z	NONE	H171	5KH37PN33	✓	\$196	F1	4.2/2.7	21	10.69	8,20,54
	1725/1140	115	48	AUTO	4399	5KH39QN9551X	✓	\$250	F1	4.2/2.7	22	10.40	20,54
	1725/1140	115	56Z	AUTO	HG704	5KH35MNA568T	✓	\$255	F1	5.2/2.8	17	10.18	17,20,48
	1725/1140	230	48	AUTO	4412	5KH39QN9550X	✓	\$281	F1	2.1/1.3	22	10.40	20,39
	1725	115	48	AUTO	4305	5KH39QN5511X	✓	\$130	F1	5.1	13	8.93	20
	1725	115	48	NONE	4355	5KH39QN5225	✓	\$154	F1	5.1	13	8.93	20,47
	1725	115	48Y	AUTO	4701	5KH39QN5512T	✓	\$128	F1	5.1	12	9.12	CF,20,53
	1725	115	48YZ	AUTO	B206	48S17D2107	✓	\$134	F1	5	14	9.62	8,20,26
	1725	115	48Z	NONE	H160	5KH32FN3083	✓	\$153	F1	5.1	14	9.32	CF,20,31,52
	1725	115	48YZ	NONE	B302	48S17D2054	✓	\$156	F1	5	14	9.57	9,20,28
	1725	115	48Z	AUTO	H915	5KH33FNA722X	✓	\$167	F1	5.6	14	9.99	7,20,26
	1725	115/230	48Y	AUTO	4702	5KH33HN5725X	✓	\$162	F1	5.2/2.6	15	9.62	20,48
	1725	115	48Y	AUTO	HG701	5KH32DN5618X	✓	\$139	F1	5.1	13	8.94	9,20
	1725	115/208-230	48Z	AUTO	4680	5KH32FN3120T	✓	\$219	F1	5.0/2.5	13	9.94	8,20
	1725	115	48Z	AUTO	HG161	5KH32FN3083X	✓	\$160	F1	5.1	14	9.32	CF,20,31,52
	1725	115	48YZ	AUTO	B303	48S17D2055	✓	\$163	F1	5	14	9.57	20,32,53
	1725	115	56Z	AUTO	B201	56S17D2047	✓	\$134	F1	5	14	9.47	8,20,26
	1725	115	56Z	AUTO	4363	5KH39QN5526X	✓	\$176	F1	5.1	14	9.19	20
	1725	230	48	AUTO	4306	5KH39QN5537X	✓	\$139	F1	2.5	13	9.09	20
	1725	230	48	NONE	4360	5KH39QN5548	✓	\$170	F1	2.5	13	8.93	20,31,52
	1725	277	48YZ	NONE	B606	48S17D2116	✓	\$174	F1	2.1	13	9.47	20,31
	1140/850	115	56	NONE	H300	5KH49SN3048	✓	\$514	F1	5.8/3.6	30	12.01	20
	1140	115	56	AUTO	H163	5KH46MN6053X	✓	\$356	F1	5.6	23	10.88	20
	1140	115	56	NONE	H162	5KH46MN6053	✓	\$348	F1	5.6	27	10.88	19
	850	115	56	NONE	H296	5KH49SN3046	✓	\$598	F1	6.9	30	12.01	20
1/3	3450	115	48	NONE	H114	5KH35FN124	✓	\$198	F1	5.6	15	9.57	20
	3450	115	48	AUTO	HG115	5KH35FN124X	✓	\$211	F1	5.6	15	9.57	9,20
	3450	115/230	48Z	AUTO	4798	5KH35FN153T	✓	\$230	F1	6.8/3.4	13	10.25	9,20

Fan and Blower, Split Phase, Dripproof Resilient Base (Single & Two-Speed)

HP	RPM	VOLTS	FRAME	OVER LOAD	CAT. NO.	MODEL NO.	STOCK	LIST PRICE	MULT. SYMB.	F.L. AMPS	WEIGHT	"C" DIM.	FOOT NOTES	
1/3	1725/1140	115	48	AUTO	4319	5KH39QN9429T	✓	\$256	F1	6.3/3.1	22	10.40	20,94	
	1725/1140	115	48	NONE	4396	5KH39QN9683	✓	\$246	F1	6.3/3.1	21	10.40	17,54	
	1725/1140	115	48Y	AUTO	D181	048S17D7205	✓	\$230	F1	5.3/2.9	20	10.06	20	
	1725/1140	115	56	NONE	H173	5KH46MN3025	✓	\$247	F1	5.7/3.2	24	10.88	20,31	
	1725/1140	115	56	AUTO	H174	5KH46MN3025X	✓	\$254	F1	5.7/3.2	32	10.88	20,31	
	1725/1140	115	56Z	AUTO	HG706	5KH37PNA569T	✓	\$292	F1	6.0/3.8	20	11.01	17,48	
	1725/850	115	56Z	AUTO	HG705	5KH46NN3039T	✓	\$444	F1	4.7/2.6	25	10.90	17,48	
	1725	115	48Y	AUTO	D143	048S17D2086	✓	\$152	F1	6.1	15	9.34	20	
	1725	115	48Y	AUTO	B703	048N17D14	✓	\$204	F1	3.2	17	9.84	20,74	
	1725	115	48Y	AUTO	HG711	5KH32HNN5620T	✓	\$149	F1	6.6	14	8.94	4,20,26,48	
	1725	115	48Y	AUTO	HG700	5KHC37NNA167T	✓	\$261	F1	3.7	24	10.39	ES,20,26,47	
	1725	115	48YZ	AUTO	B207	048S17D2108	✓	\$152	F1	5.5	15	9.62	CF,20,53	
	1725	115	48Z	NONE	H164	5KH32JN3128	✓	\$177	F1	6.2	15	9.32	8,20	
	1725	115	48YZ	NONE	B304	048S17D2056	✓	\$180	F1	5.5	15	9.32	CF,20,31,52	
	1725	115	48Z	AUTO	H917	5KH35JNA723X	✓	\$190	F1	6.9	15	10.37	9,20,28	
	1725	115	48Z	AUTO	H165	5KH32JN3128X	✓	\$183	F1	6.2	16	9.32	8,20	
	1725	115	48YZ	AUTO	B305	048S17D2057	✓	\$186	F1	5.5	15	9.32	CF,20,31,52	
	1725	115	56Z	AUTO	B202	56S17D2048	✓	\$156	F1	6.1	15	9.72	20,32,53	
	1725	230	48Z	AUTO	H167	5KH35JN26X	✓	\$160	F1	3.3	16	9.95	8,20	
	1725	230	48	AUTO	4309	5KH39QN9514X	✓	\$232	F1	3.1	15	9.18	20	
	1725	115	48	NONE	4370	5KH39QN9682	✓	\$213	F1	6.2	15	9.18	20	
	1725	115/208-230	56Z	AUTO	4682	5KH35JN3132T	✓	\$246	F1	6.2/3.1	16	10.26	9,20,26,72	
	1725	230	48Z	NONE	H166	5KH35JN26	✓	\$235	F1	3.3	16	9.95	8,20	
	1725	230	56Z	AUTO	4757	5KH39QN9636T	✓	\$243	F1	3.1	16	9.19	7,20,26	
	1725	277	48YZ	NONE	B607	048S17D2117	✓	\$196	F1	2.5	15	9.72	20,31,52	
	1725	115	56Z	AUTO	4383	5KH39QN9513X	✓	\$228	F1	6.2	15	9.19	8,26	
	1140	115/230	56	NONE	H168	5KH49PN6055	✓	\$404	F1	7.0/3.5	27	11.48	20	
	1140	115/230	56	AUTO	HG621	5KH49PN6055X	✓	\$419	F1	7.0/3.5	26	11.48	20	
	1/2	1725/1140	115	56	NONE	H175	5KH49PN3026	✓	\$312	F1	8.0/4.2	31	11.48	19,31
		1725/1140	115	56	AUTO	H176	5KH49PN3026X	✓	\$319	F1	8.0/4.2	31	11.48	19,31
1725/1140		115	56	NONE	H130	5KH39QN9632	✓	\$350	F1	8.4/4.8	22	10.32	17	
1725/1140		115	56	AUTO	H131	5KH39QN9631T	✓	\$362	F1	8.4/4.8	22	10.32	17,31	
1725/1140		115	56Z	AUTO	HG715	5KH38SNA731T	✓	\$412	F1	7.8/4.8	25	11.44	17,48	
1725/1140		230	56	NONE	H275	5KH49PN3045	✓	\$436	F1	3.8/1.9	28	11.48	19,31	
1725/1140		230	56	AUTO	H133	5KH39QN9642T	✓	\$378	F1	4.1/2.4	22	10.32	17,31	
1725		115	48Y	AUTO	D162	048S17D2087	✓	\$207	F1	7.2	19	10.09	19	
1725		115	48Y	AUTO	HG703	5KH35MNA519T	✓	\$200	F1	7.9	15	10.32	19,48	
1725		115	48YZ	AUTO	B208	048S17D2109	✓	\$207	F1	7.5	20	10.43	CF,19,53	
1725		115	48YZ	NONE	B306	048S17D2058	✓	\$218	F1	7.5	18	10.32	CF,19,31,52	
1725		115	48	AUTO	HG694	5KH39QN9767X	✓	\$231	F1	7.1	19	9.99	19	
1725		115	48YZ	AUTO	B307	048S17D2059	✓	\$237	F1	7.5	18	10.32	CF,19,31,52	
1725		115	56Z	AUTO	H919	5KH36MNA735X	✓	\$234	F1	8.7	18	10.80	10,19,28	
1725		115	56	AUTO	4392	5KH39QN9405X	✓	\$230	F1	7.9	21	10.32	19	
1725		115	56	NONE	4390	5KH39QNA039	✓	\$258	F1	7.9	17	10.32	19	
1725		115	56	AUTO	D149	056S17D2050	✓	\$212	F1	7.2	19	10.47	19	
1725		115	56	AUTO	H248	5KH36MN3106X	✓	\$262	F1	9.3	18	10.32	19	
1725		115	56	NONE	H286	5KH36MN3106	✓	\$258	F1	9.3	18	10.32	19	
1725		115	56Z	AUTO	B200	056S17D2049	✓	\$212	F1	7.2	19	10.47	19,32,53	
1725		115	56Z	AUTO	4758	5KH39QN9698T	✓	\$269	F1	7.9	22	9.99	7,19,26	
1725		115/230	56	AUTO	B100	056S17D2064	✓	\$223	F1	7.2/3.6	20	10.47	19	
1725		115/230	56Z	AUTO	4684	5KH36MN3127T	✓	\$304	F1	8.9/4.5	18	10.69	9,26	
1725		230	56	AUTO	4393	5KH39QN9544X	✓	\$281	F1	4.5	21	10.32	19	
1725		230	56Z	AUTO	4759	5KH39QN9697T	✓	\$217	F1	4.0	17	9.99	19	
1725		230	48Y	AUTO	D163	048S17D2088	✓	\$217	F1	3.6	19	10.09	19	
1140		115/230	56	AUTO	H298	5KH48UN6054X	✓	\$536	F1	9.0/4.5	32	12.76	19	
3/4		1725	115	56	AUTO	4338	5KH39QN9541T	✓	\$275	F1	11.4	21	10.72	18

Fan and Blower - Capacitor Start, Dripproof Resilient Base (Single & Two-Speed)



Features:

- Ball bearings
- Heavy gauge steel frame and base
- Service Factor, as noted
- Capacitor start / capacitor run as noted
- Thermal protection, as noted
- 48Y and 48YZ Frame have 48/56 Frame mounting holes
- UL Recognized and CSA Certified

HP	RPM	VOLTS	FRAME	OVER LOAD	CAT. NO.	MODEL NO.	STOCK	LIST PRICE	MULT. SYMB.	F.L. AMPS	WEIGHT	"C" DIM.	FOOT NOTES	
1/4	1725	115/230	48	NONE	G1114	5KC35JN7J	✓	\$173	F1	5.2/2.6	16	9.57	20	
	1725	115/208-230	48YZ	AUTO	B313	48C17D2042	✓	\$203	F1	5.2/2.8-2.6	16	9.95	CF,20,31,52	
	1725	115/208-230	48YZ	NONE	B312	48C17D2041	✓	\$194	F1	6.2/2.8-3.1	15	9.72	20,31,52	
	1725	115/230	48	AUTO	G1115	5KC35JN7X	✓	\$183	F1	5.2/2.6	16	9.57	20	
1/3	1725	115/208-230	48YZ	NONE	B314	48C17D2043	✓	\$229	F1	5.8/3.1-2.9	18	10.22	20,31,52	
	1725	115/208-230	48YZ	AUTO	B315	48C17D2044	✓	\$237	F1	5.8/3.1-2.9	17	10.22	20,31,52	
	1725	115/208-230	56	AUTO	C216	5KC36LN1X	✓	\$241	F1	6.0/3.2-3.0	18	10.32	20,50	
	1725	115/230	48YZ	AUTO	D119	48C17D2055	✓	\$218	F1	5.8/2.9	12	10.22	20,31,52	
	1725	115/230	56	AUTO	G135	56C17D2088	✓	\$221	F1	6.4/3.2	18	10.22	20	
	1/2	3450	115/208-230	48	AUTO	C1152	5KC39QN3220X	✓	\$175	F1	8.2/3.9-4.1	19	11	19
1725/1140	115	56	AUTO	C419	5KC49PN3027X	✓	\$499	F1	8.2/3.9	28	11.38	19		
1725	115/208-230	56	NONE	B1316	5KC49GN0001	✓	\$259	F1	8.8/4.2-4.4	21	10.38	19		
1725	115/208-230	56	AUTO	C1153	5KC49GN0022X	✓	\$293	F1	8.6/4.1-4.3	21	10.38	19		
1725	115/208-230	56	AUTO	B317	56C17D2072	✓	\$299	F1	8.0/4.1-4.0	20	10.32	CF,19,31		
1725	115/208-230	56Y	AUTO	B353	56B17D67	✓	\$320	F1	6.2/3-3.1	24	12.92	1,19,55		
1725	115/230	56	AUTO	D111	56C17D2079	✓	\$263	F1	7.2/3.6	20	10.72	19		
1725	115/230	56	AUTO	G151	56C17D2025	✓	\$263	F1	8.6/4.3	24	11.72	19		
1725	277	56	NONE	B608	56C17D2113	✓	\$296	F1	3.6	23	11.72	19		
3/4	3450	115/208-230	56	AUTO	C1155	5KC38NN410X	✓	\$229	F1	10.0/4.9-5.0	17	11.32	19	
	3450	115/208-230	48	AUTO	C1154	5KC38NN413X	✓	\$322	F1	9.8/5.0-4.9	17	11	19	
	1725/1140	115	56	AUTO	B332	56B17D5701	✓	\$473	F1	8.9/6.1	40	12.85	1,19,31	
	1725/1140	115	56	NONE	C420	5KCR49PN3011	✓	\$463	F1	9.0/6.4	31	11.48	ES,1,19	
	1725/1140	208-230	56	NONE	C486	5KCR49PN3012X	✓	\$472	F1	4.3-4.4/3.1-3.2	38	11.48	ES,1,19	
	1725/1140	115	56	AUTO	C474	5KCR49PN3011X	✓	\$545	F1	9.0/6.4	31	11.48	ES,1,19	
	1725	115/208-230	56	AUTO	C1156	5KC46LN0149X	✓	\$353	F1	13.3/6.5-6.6	27	10.78	19	
	1725	115/208-230	56	AUTO	B319	56C17D2074	✓	\$363	F1	10.0/5.2-5.0	23	10.72	CF,19,31	
	1725	115/208-230	56	NONE	CG230	5KC46LN0158	✓	\$326	F1	13.2/6.2-6.6	25	10.78	19	
	1725	115/208-230	56	NONE	B318	56C17D2073	✓	\$337	F1	10.0/5.2-5.0	24	10.72	CF,19,31	
	1725	115/208-230	56	NONE	G156	56B17D2012	✓	\$324	F1	11.0/5.5-5.5	26	11.47	1,19	
	1725	115/208-230	56Z	AUTO	4686	5KC46LN0269X	✓	\$385	F1	13.3/6.5-6.6	25	11.15	10,19	
	1725	115/230	56	AUTO	D1113	5KC46LN0158X	✓	\$325	F1	13.2/6.6	25	10.78	19	
	1725	277	56	NONE	B609	56B17D2013	✓	\$360	F1	4.3	27	11.47	1,19,31	
	1	3450	115/208-230	56	AUTO	C1157	5KC39RN383X	✓	\$284	F1	13.4/6.7-6.6	25	11.85	19
		3450	115/208-230	56	AUTO	D118	56C34D2106	✓	\$266	F1	12.0/6.2-6.0	25	12.22	18
1725/1140		115	56	AUTO	B335	56B17D5703	✓	\$589	F1	11.5/7.0	39	12.85	1,18,31	
1725/1140		115	56	NONE	C475	5KCR49SN3009	✓	\$578	F1	10.8/7.4	35	12.01	ES,1,18	
1725/1140		115	56	AUTO	C1478	5KCR49SN3009X	✓	\$604	F1	10.8/7.4	30	12.01	ES,1,18	
1725/1140		208-230	56	NONE	C476	5KCR49SN3010	✓	\$601	F1	5.3-5.4/3.6-3.7	35	12.01	ES,1,18	
1725/1140		208-230/190-380	56H	AUTO	C1479	5KCR48TN3084X	✓	\$613	F1	5.3-5.4/3.6-3.7	36	12.54	ES,1,17	
1725		115/208-230	56	AUTO	C1158	5KC49PN0164X	✓	\$369	F1	14.7/7.2-7.4	29	11.38	18	
1725		115/208-230	56Z	AUTO	4688	5KC49NN0061T	✓	\$374	F1	14.4/7.2-7.4	28	11.75	10,18	
1725		115/208-230	56H	NONE	C235	5KC49PN0155	✓	\$344	F1	13.6/6.7-6.8	31	11.38	18	
1725		277	56	NONE	B337	56C17D5348	✓	\$386	F1	5.6	29	11.85	19,32	
1 1/2		3450	115/208-230	56H	AUTO	D115	56B34D2027	✓	\$370	F1	13.4/7.4-6.7	28	11.72	1,18
		1725	115/208-230	145T	NONE	I146	145TCDR5331	✓	\$419	S1	18.0/9.3-9.0	42	13.22	18,32
		1725	115/208-230	56H	NONE	B336	56C17D5347	✓	\$413	F1	18.0/9.3-9.0	39	12.85	5,18,32
	1725	115/208-230	56H	AUTO	C1160	5KCR49SN0150X	✓	\$429	F1	16.4/8.4-8.2	35	11.91	ES,1,18	
	1725	277	56H	NONE	B338	56C17D5349	✓	\$447	F1	7.5	41	12.85	5,18,32	
2	3450	115/208-230	56H	AUTO	C1161	5KCR49RN2148T	✓	\$451	F1	19.6/10.4-9.8	33	11.91	ES,1,110	
	1725	115/208-230	56H	AUTO	B352	56B17D5331	✓	\$547	F1	21/11.3-10.5	50	13.85	1,5,32	
	1725	115/208-230	145T	NONE	I147	145TBDR5345	✓	\$440	S1	21/11.3-10.5	49	14.22	1,18	

Fan and Blower, Split Phase and Capacitor Start Totally Enclosed, Resilient Base (Single & Two-Speed)

Features:

- Thermal protection, as noted
- 1.0 Service Factor (except as noted)
- Heavy gauge steel frame and base
- Split phase (except as noted)
- Ball bearings
- UL Recognized and CSA Certified



HP	RPM	VOLTS	FRAME	OVER LOAD	CAT. NO.	MODEL NO.	STOCK	LIST PRICE	MULT. SYMB.	F.L. AMPS	WEIGHT	"C" DIM.	FOOT NOTES
1/6	1725	115	48	NONE	HG178	5KH32EN79	✓	\$242	F1	4.0	15	9.92	
	1725	115	48	AUTO	H291	5KH32EN72X	✓	\$255	F1	4.0	15	9.92	CF,31
	1140	115	48	NONE	H233	5KH36PN109	✓	\$335	F1	4.0	23	10.98	
1/4	1725	115	48	AUTO	H234	5KH39QN9105X	✓	\$177	F1	5.1	17	9.92	
	1725	115	48	NONE	B1502	5KH39QN9105	✓	\$170	F1	5.1	17	9.92	
	1725	115/230	48	NONE	C247	5KC32GN13	✓	\$300	F1	5.4/2.7	17	9.92	2
	1725/1140	115	48	NONE	HG189	5KH36PN108	✓	\$335	F1	4.2/2.7	23	10.98	
	1140	115/230	56	NONE	HG182	5KH49MN6060	✓	\$386	F1	5.6/2.8	25	11.54	
1/3	1725	115	56	NONE	B1504	5KH35MN56	✓	\$210	F1	5.9	20	10.93	
	1725	115	56	AUTO	H236	5KH35MN56X	✓	\$217	F1	5.9	20	10.93	
	1725/1140	115	56	NONE	H190	5KH49MN3035	✓	\$416	F1	5.7/3.2	27	11.54	
	1140	115	56	NONE	HG186	5KH46PN6059	✓	\$444	F1	7.0	31	11.94	
1/2	1725	115	56	AUTO	B506	56S17F5303		\$298	F1	8.4	27	12.30	
	1725	115	56	NONE	B1507	5KH42GN0336	✓	\$252	F1	8.0	21	11.11	19
	1725	115/230	56	AUTO	C289	5KC42GN0309X	✓	\$405	F1	8.6/4.3	21	11.11	2,18
	1725/1140	115	56	NONE	HG191	5KH46PN3033	✓	\$463	F1	8.0/4.2	29	11.94	
	1725/1140	230	56	NONE	H293	5KH46PN3034	✓	\$475	F1	3.8/1.9	31	11.94	
	1140	115	56	NONE	HG188	5KH49UN6064	✓	\$565	F1	9.0	40	13.07	
3/4	1725	115/230	56	AUTO	C806	5KC49PN0281X	✓	\$471	F1	11.0/5.5	32	12.54	2,17
1	1725	115/230	56	AUTO	C292	5KC49TN0285X	✓	\$520	F1	13.2/6.6	38	13.07	2

Fan & Blower - Three Phase

TEAO, Resilient Base

Applications:

Designed for applications like commercial fans and blowers, direct and belt drive air handlers and exhaust fans.

Features:

- Ball bearings
- 1.0 Service Factor
- .62" extended thru-bolts
- UL Recognized and CSA Certified



HP	RPM	VOLTS	FRAME	CAT. NO.	MODEL NO.	STOCK	LIST PRICE	MULT. SYMB.	F.L. AMPS	WEIGHT	"C" DIM.	FOOT NOTES
1/4	1800	230/460	48	K281	5K32GN48	✓	\$282	F1	1.4/0.7	14	8.94	
	1200	230/460	56	K282	5K35MN294	✓	\$405	F1	1.4/0.7	18	9.89	
1/3	1800	230/460	48	K283	5K33KN52	✓	\$316	F1	1.5/0.8	16	9.19	
1/2	1800	208-230/460	56	K284	5K42HN4128	✓	\$355	F1	2.3-2.2/1.1	22	10.05	
	1200	208-230/460	56	K285	5K49MN6080	✓	\$475	F1	2.6-2.6/1.3	24	10.48	
	1200	208-230/460	56	K541	5K49MN6081	✓	\$514	F1	2.6-2.6/1.3	27	11.54	
3/4	1800	208-230/460	56	K286	5K49KN4142	✓	\$383	F1	3.3-3.0/1.5	21	10.48	
1	1800	208-230/460	56	K525	5K49MN4114	✓	\$402	F1	3.6-3.8/1.9	25	10.48	

Fan & Blower - Three Phase, Dripproof Resilient Base (Single and Two-Speed)

Features:

- Single and two-speed models, as noted
- Variable torque on two speed ratings
- Ball bearings
- Heavy gauge steel frame and base
- Thermal protection, as noted
- Service Factor, as noted
- Nameplated 60/50 Hz at next lower horsepower (except as noted)
- Patented VCD™, Voltage Change Device where footnoted "VC"
- UL Recognized and CSA Certified



As Noted

HP	RPM	VOLTS	FRAME	OVER LOAD	CAT. NO.	MODEL NO.	STOCK	LIST PRICE	MULT. SYMB.	F.L. AMPS	WEIGHT	"C" DIM.	FOOT NOTES
1/4	1800	230/460	48Z	NONE	K275	5K33GN45	✓	\$267	F1	1.4/0.7	14	9.57	20
1/3	1800/1200	460	56	NONE	G161	056T17D5701		\$352	F1	0.6/0.4	33	12.35	20
	1800	208-230/460	56	AUTO	G106	056T17D2104	✓	\$280	F1	1.5-1.6/8	16	9.97	20
	1800	208-230/460	56	NONE	G162	056T17D2121	✓	\$232	F1	1.5-1.6/8	16	9.97	20
1/2	1800	575	56	NONE	G964	056T17D2117		\$232	F1	0.64	16	9.97	20,70
	1800/1200	200-230	56	NONE	K544	5K42JN3051	✓	\$382	F1	2.4-2.8/1.5-1.7	23	10.05	19
	1800/1200	460	56	NONE	K546	5K42JN3050	✓	\$382	F1	1.1/0.6	22	10.05	19
	1800	208-230/460	56	AUTO	K1408	5K42HN4089X	✓	\$310	F1	2.3-2.2/1.1	20	10.05	19
	1800	208-230/460	56	NONE	K381	5K42HN4089	✓	\$262	F1	2.3-2.2/1.1	20	10.05	19
	1800	208-230/460	56	AUTO	G140	056T17D5345	✓	\$324	F1	2.3-2.4/1.2	22	10.85	VC,19
3/4	1800	575	56	NONE	G961	056T17D2118	✓	\$261	F1	0.9	18	10.47	19,70
	3600	208-230/460	56	AUTO	K1409	5K37MN252X	✓	\$284	F1	2.6-2.6/1.3	16	10.72	19
	1800/1200	200-230	56	NONE	K279	5K49PN3053	✓	\$454	F1	2.8-3.0/1.6-1.8	31	11.48	19
	1800/1200	460	56	NONE	K280	5K49PN3052	✓	\$454	F1	1.3/0.7	28	11.48	19
	1800	208-230/460	56	AUTO	K1410	5K46KN4085X	✓	\$339	F1	3.3-3.0/1.5	21	10.88	19
	1800	208-230/460	56	AUTO	G141	056T17D5346	✓	\$354	F1	2.9-3.0/1.5	23	10.85	VC,19
1	1800	208-230/460	56	NONE	K277	5K46KN4085	✓	\$293	F1	3.3-3.0/1.5	25	10.88	19
	1800	575	56	NONE	G962	056T17D2119	✓	\$292	F1	1.1	21	10.97	19,70
	3600	208-230/460	56	AUTO	K1411	5K38PN258X	✓	\$316	F1	3.3-3.2/1.6	18	11.32	19
	1800/1200	200-230	56	NONE	K518	5K49SN3054	✓	\$470	F1	3.7-3.9/2.0-2.2	35	12.01	18
	1800/1200	460	56	NONE	K519	5K49SN3055	✓	\$470	F1	1.8/1.1	35	12.01	18
	1800	208-230/460	56	AUTO	K1412	5K46MN4087X		\$360	F1	3.6-3.8/1.9	27	10.88	18
	1800	208-230/460	56	AUTO	G142	056T17D5347	✓	\$360	F1	3.5-3.6/1.8	25	11.35	VC,18
	1800	208-230/460	56H	AUTO	G100	056T17D2101	✓	\$346	F1	3.4-3.4/1.7	24	11.47	5,18
1 1/2	1800	208-230/460	56	NONE	K278	5K46MN4087	✓	\$301	F1	3.6-3.8/1.9	27	10.88	18
	1800	575	56H	NONE	G963	056T17D2120	✓	\$300	F1	1.4	23	11.47	5,18,70
	3600	208-230/460	56H	AUTO	K1413	5K49KN2150X	✓	\$377	F1	5.0-4.8/2.4	26	12.01	18
	1800/1200	200-230	56H	NONE	K520	5K48UN3056	✓	\$484	F1	5.0-5.3/2.8-3.1	40	12.76	18
	1800/1200	460	56H	NONE	K549	5K48UN3057	✓	\$484	F1	2.3/1.4	40	12.76	18
	1800	208-230/460	56	NONE	G122	056T17D5329	✓	\$333	F1	4.8-4.8/2.4	28	11.35	18
	1800	208-230/460	56H	AUTO	K1415	5K49PN4088X	✓	\$378	F1	5.5-5.6/2.8	31	12.01	18
	1800	208-230/460	56	AUTO	G143	056T17D5348	✓	\$393	F1	4.8-4.8/2.4	28	11.35	VC,18
2	1800	208-230/460	145T	AUTO	K2030	5KE49TN8384T		\$409	E6	4.5-4.4/2.2	40	13.19	18,70
	1800	575	56H	AUTO	G965	056T17D5357		\$377	F1	1.9	29	11.35	18,70
	3600	208-230/460	56H	AUTO	K1416	5K49NN2147X	✓	\$435	F1	6.0-6.0/3.0	30	12.01	18
	1800	208-230/460	56H	AUTO	G144	056T17D5349	✓	\$435	F1	6.2-6.2/3.1	35	12.35	VC,5,18
3	1800	208-230/460	56H	NONE	G127	056T17D5332	✓	\$364	F1	6.2-6.2/3.1	34	12.35	5,18
	1800	208-230/460	56H	AUTO	K1418	5K49UN4086X	✓	\$412	F1	6.2-6.0/3.0	39	13.96	5,18
	1800	575	56H	AUTO	G967	056T17D5385		\$411	F1	2.5	36	12.35	5,18,70
	3600	208-230/460	56HZ	AUTO	B193	056T34D5357	✓	\$488	F1	8.9-8.4/4.2	34	12.22	Z,5,18
	3600	208-230/460	145T	AUTO	K2037	5KE49UN8376T		\$476	E6	8.4-7.6/3.8	34	13.19	18,70
	1800	208-230/460	56HZ	AUTO	G145	056T17D5350	✓	\$458	F1	9.2-8.6/4.3	48	14.22	Z,VC,5,18
5	1800	208-230/460	56HZ	AUTO	K1497	5K49WN4335X	✓	\$508	F1	10.2/4.8	44	15.31	11,18
	3600	208-230/460	56HZ	AUTO	X251	056T34D5364	✓	\$654	F1	13.5-12.4/6.2	50	13.49	Z,5,12,17,70
	3600	230/460	145T	AUTO	K2038	5KE49QN8375T		\$541	E6	12.4/6.2	54	14.19	17,70

Exhaust Ventilator, Single Phase

Dripproof, C-Face Footless, Single Speed

Features:

- Split phase (except as noted)
- Thermal protection, as noted
- Service Factor, as noted
- Motors with 56CZ frames have 2-1/4 x 5/8 shaft dimensions
- Ball Bearings



HP	RPM	VOLTS	FRAME	OVER LOAD	CAT. NO.	MODEL NO.	STOCK	LIST PRICE	MULT. SYMB.	F.L. AMPS	WEIGHT	"C" DIM.	FOOT NOTES
1/12	1140	115	56CZ	NONE	H204	5KH32GN142	✓	\$247	F1	2.4	13	9.62	112
	850	115	56CZ	NONE	H205	5KH37PN37	✓	\$358	F1	3.2	19	11.08	112
	850	115	56CZ	AUTO	H278	5KH37PN37X	✓	\$367	F1	3.2	19	11.08	112
1/8	1140	115	56CZ	AUTO	H287	5KH36KN112X	✓	\$285	F1	3.8	15	10.68	112
	1140	115	56CZ	NONE	H206	5KH36KN112	✓	\$271	F1	3.8	15	10.68	112
	850	115	56CZ	NONE	H207	5KH46MN3041	✓	\$439	F1	4.6	22	11.15	112
1/6	1725	115	56CZ	NONE	H208	5KH32DN111	✓	\$145	F1	4.2	11	9.62	20
	1140/850	115	56CZ	NONE	H222	5KH49PN3047	✓	\$431	F1	4.2/2.9	43	11.70	20
	1140	115	56CZ	AUTO	H210	5KH37PN36X	✓	\$316	F1	4.0	19	11.08	20
1/4	1140	115	56CZ	NONE	H209	5KH37PN36	✓	\$221	F1	4.0	19	11.08	20
	1725	115	56CZ	NONE	H212	5KH33FN77	✓	\$154	F1	5.6	13	9.87	20
	1725	115	56CZ	AUTO	H213	5KH33FN77X	✓	\$231	F1	5.6	13	9.87	20
	1725/1140	115	56CZ	NONE	H223	5KH37PN40	✓	\$296	F1	4.2/2.7	20	11.08	20
	1140/850	115	56CZ	NONE	H224	5KH49SN3049	✓	\$525	F1	5.8/3.6	29	11.91	20
	1140	115	56CZ	NONE	H214	5KH46MN6071	✓	\$262	F1	5.6	22	11.15	20
	1140	115	56CZ	AUTO	H215	5KH46MN6071X	✓	\$361	F1	5.6	22	11.15	20
	850	115	56CZ	AUTO	H288	5KH49SN3023X	✓	\$617	F1	6.9	31	13.59	20
1/3	1725	115	56CZ	NONE	H217	5KH35JN121	✓	\$174	F1	6.6	14	10.25	20
	1725	115	56CZ	AUTO	H218	5KH35JN121X	✓	\$261	F1	6.6	14	10.25	20
	1725/1140	115	56CZ	NONE	H225	5KH46MN3040	✓	\$368	F1	5.7/3.2	22	11.15	20
	1140	115	56CZ	NONE	H219	5KH49PN6069	✓	\$432	F1	7.0	31	11.70	20
1/2	850	115	56CZ	AUTO	H280	5KH49UN3024X	✓	\$647	F1	9.2	40	13.59	20
	1725	115	56CZ	NONE	H290	5KH36MN137	✓	\$230	F1	7.2	16	11.31	19
	1725/1140	115	56CZ	AUTO	H282	5KH49PN3042X	✓	\$444	F1	8.0/4.2	31	11.70	19
	1725/1140	115	56CZ	NONE	H226	5KH49PN3042	✓	\$432	F1	8.0/4.2	26	11.70	19
	1140	115	56CZ	NONE	H221	5KH48UN6074	✓	\$490	F1	9.0	34	12.66	19
1140	115/208-230	56C	NONE	G278	56C11D5304	✓	\$448	F1	10.6/5.1-5.3	32	11.94	2,19	

Furnace Blower, Split Phase

Open, PDQ Mounting

Applications:

Designed for replacement of virtually any NEMA 48 and 56 frame belt drive furnace blower motors. PDQ models have 1 1/2" extended splined hub on opposite shaft end for quick and easy positioning of resilient ring to properly fit the pre-existing motor base.

Features:

- Ball bearings
- Reversible rotation connected for CCW rotation from factory
- NEMA service factors
- 4733, 4734 and 4735 have both 48 and 56 frame mounting holes and includes mounting base
- UL Recognized and CSA Certified



HP	RPM	VOLTS	FRAME	OVER LOAD	CAT. NO.	MODEL NO.	STOCK	LIST PRICE	MULT. SYMB.	F.L. AMPS	WEIGHT	"C" DIM.	MIN/MAX BASE DIM'S	FOOT NOTES
1/4	1725	115	48Y	AUTO	4733	5KH39DNA533T	✓	\$159	F1	5.1	13	9.78	6.62" & 7.91"	
	1725	115	48Y	AUTO	4730	5KH39QN9725T	✓	\$146	F1	5.0	13	9.78	6.62" & 7.91"	30
1/3	1725	115	48Y	AUTO	4734	5KH32HNA532T	✓	\$171	F1	6.6	15	10.03	6.87" & 8.16"	
	1725	115	48Y	AUTO	4731	5KH39QN9696X	✓	\$157	F1	5.8	15	10.28	7.12" & 8.41"	30
	1725	230	48Y	AUTO	4738	5KH39QN9703T	✓	\$256	F1	3.1	15	10.28	7.12" & 8.41"	30
1/2	1725	115	48Y	AUTO	4732	5KH39QN9702T	✓	\$207	F1	7.9	17	10.66	7.50" & 8.79"	30
	1725	115	48Y	AUTO	4735	5KH33JNA534T	✓	\$224	F1	7.9	15	10.28	6.62" & 7.91"	
	1725	230	48Y	AUTO	4739	5KH39QN9704T	✓	\$323	F1	4.0	17	10.66	7.50" & 8.79"	30

Oil Burner, Split Phase and Capacitor Start NEMA 48M and 48N Flange Mount

Applications:

Direct replacement motors for residential and commercial oil burners and hot water pressure/steam cleaners.

Features:

- Ball Bearings (except as noted)
- Semi- or totally enclosed steel frame
- 20" Long leads from a 1/2" NPT opening (totally enclosed footnoted with N)
- Split phase and capacitor start designs
- Two-bolt, NEMA N- or M-Flange direct
- Catalog numbers 4781, 4788, O010 mounting and O011 have dripproof enclosures
- 1.0 Service Factor



HP	RPM	VOLTS	FRAME	OVER LOAD	CAT. NO.	MODEL NO.	STOCK	LIST PRICE	MULT. SYMB.	F.L. AMPS	WEIGHT	"C" DIM.	FOOT NOTES
1/8	3450	115	48N	MANUAL	O005	48S34S2004	✓	\$128	F1	2.4	9	7.09	3,61
	1725	115	48N	MANUAL	O600	48S17T286	✓	\$112	F1	2.8	11	7.7	CF,N,3
1/7	3450	115	48M	MANUAL	O100	48S34S361	✓	\$138	F1	2.8	11	7.7	CF,3
1/6	3450	115	48M	MANUAL	O102	48S34S2005	✓	\$146	F1	3.0	11	7.25	3
	1725	115	48N	MANUAL	O601	48S17T290	✓	\$120	F1	2.7	12	7.59	CF,N,3
1/5	3450	115/230	48N	MANUAL	O012	48C34S24	✓	\$170	F1	3.0/1.5	14	8.35	2,61
1/4	3450	115	48N	MANUAL	O004	48S34S2003	✓	\$170	F1	4.2	13	8.13	CF,3
	3450	115/230	48N	MANUAL	O013	48C34S2001		\$177	F1	4.4/2.2	19	8.6	2
	1725	115	48N	MANUAL	O002	48S17S25	✓	\$145	F1	4.2	12	7.59	3
1/3	3450	115/230	48N	MANUAL	4788	5KC37EN3900U	✓	\$186	F1	6.0/3.0	14	10.13	d
	3450	115/208-230	48N	MANUAL	O010	48C34D2024	✓	\$186	F1	5.6/2.7-2.8	14	10.34	2
	3450	115	48N	MANUAL	4774	5KH33GN5014U	✓	\$173	F1	4.9	15	8.38	3,4
	1725	115	48N	MANUAL	O003	48S17S24	✓	\$168	F1	5.0	17	8.34	3
1/2	3450	115/230	48N	MANUAL	4781	5KC37HN3898U		\$229	F1	8.2/4.1	15	10.13	
	3450	115/208-230	48N	MANUAL	O011	48C34D2028	✓	\$229	F1	7.4/3.5-3.7	17	10.84	2

Oil Burner, PSC NEMA 48M Flange Mount

Applications:

Replacement motors for mini pumps in residential or light commercial furnaces.

Features:

- High efficiency design
- 14" cord for easy connection
- Ultra quiet performance
- UL Recognized and CSA Certified



HP	RPM	VOLTS	FRAME	OVER LOAD	CAT. NO.	MODEL NO.	STOCK	LIST PRICE	MULT. SYMB.	F.L. AMPS	WEIGHT	"C" DIM.	FOOT NOTES
1/7	3450	115	48M	AUTO	O701	48A34SU1001	✓	\$119	F1	1.7	8	6.61	3,61

Oil Burner, Split Phase and Capacitor Start Dripproof, NEMA 56C, C-Face Footless

Features:

- Ball Bearings
- Manual or automatic reset thermal
- Split Phase and capacitor start designs protector
- NEMA 56C direct mounting
- NEMA Jet Pump Service Factors
- Moderate starting torque
- UL Recognized and CSA Certified



HP	RPM	VOLTS	FRAME	OVER LOAD	CAT. NO.	MODEL NO.	STOCK	LIST PRICE	MULT. SYMB.	F.L. AMPS	WEIGHT	"C" DIM.	FOOT NOTES
1/4	3600	115	56C	MAN	O200	56S34D2000	✓	\$139	F1	4.3	14	10.19	3,15,115
1/3	3600	115	56C	AUTO	O201	56S34D93	✓	\$132	F1	5.6	14	10.44	2,3,15
	3600	115/230	56C	AUTO	J1025	5KC37FN71X	✓	\$154	F1	6.4/3.2	14	10.71	2,115
	3600	115/208-230	56C	MAN	O211	56C34D2109	✓	\$161	F1	5.6/2.7-2.8	14	10.44	2,115
1/2	3600	115/208-230	56C	AUTO	O210	56C34D2114	✓	\$154	F1	5.6/2.7-2.8	14	10.44	2,115
	3600	115/208-230	56C	MAN	O213	56C34D2099	✓	\$176	F1	7.4/3.5-3.7	16	10.69	2,114
	3600	115/208-230	56C	AUTO	O212	56C34D2098	✓	\$169	F1	7.4/3.5-3.7	17	10.69	2,114
3/4	3600	115/230	56C	AUTO	C330	5KC36JN268X	✓	\$205	F1	7.6/3.8	17	10.31	2,114
	3600	115/208-230	56C	MAN	O215	56C34D2112	✓	\$199	F1	9.8/4.8-4.9	18	10.94	2,113
	3600	115/208-230	56C	AUTO	O214	56C34D2104	✓	\$199	F1	9.8/4.8-4.9	20	10.94	2,113
1	3600	115/230	56C	AUTO	C332	5KC39NN50X	✓	\$199	F1	11.2/5.6	22	11.84	2,113
	3600	115/230	56C	AUTO	C334	5KC39RN44X	✓	\$223	F1	13.2/6.6	22	12.59	2,112
	3600	115/208-230	56C	MAN	O217	56C34D2105	✓	\$230	F1	12.0/6.2-6.0	24	11.94	2,112
1 1/2	3600	115/208-230	56C	MAN	O231	56B34D2028	✓	\$312	F1	13.4/7.4-6.7	25	11.97	1,111
	3600	115/208-230	56C	AUTO	C336	5KC49NN2140X	✓	\$304	F1	18.4-9.8/9.2	27	11.38	1,111
2	3600	115/208-230	56C	AUTO	C338	5KC49TN2141X	✓	\$377	F1	21.2-11.5/10.6	38	13.22	1,110
	3600	115/208-230	56C	MAN	O232	56B34D5337		\$386	F1	19.2/10.3-9.6	33	11.44	1,110
3	3600	115/230	56C	AUTO	C340	5KCR48TN2142T	✓	\$599	F1	29.4/14.7	38	12.66	1,18

Oil Burner, Three Phase Dripproof, NEMA 56C, C-Face Footless

Features:

- Double sealed ball bearings
- NEMA Jet Pump Service Factors
- NEMA 56C direct mounting
- Ball Bearings
- UL Recognized and CSA Certified



HP	RPM	VOLTS	FRAME	OVER LOAD	CAT. NO.	MODEL NO.	STOCK	LIST PRICE	MULT. SYMB.	F.L. AMPS	WEIGHT	"C" DIM.	FOOT NOTES
1/3	3600	208-230/460	56C	NONE	KG215	5K35FN55	✓	\$177	F1	1.5-1.8/0.9	14	9.88	68,115
1/2	3600	208-230/460	56C	NONE	K216	5K36JN57	✓	\$202	F1	2.0-2.0/1.0	15	10.31	68,114
3/4	3600	208-230/460	56C	NONE	K218	5K37MN37	✓	\$243	F1	2.6-2.6/1.3	17	10.7	68,113
1	3600	208-230/460	56C	NONE	K220	5K38PN47	✓	\$276	F1	3.3-3.2/1.6	20	11.3	68,112
1 1/2	3600	208-230/460	56C	NONE	K222	5K46KN2173	✓	\$336	F1	5.0-4.8/2.4	24	10.73	68,111
2	3600	208-230/460	56C	NONE	K224	5K49NN2180	✓	\$395	F1	6.0-6.0/3.0	27	11.33	68,110
3	3600	208-230/460	56C	NONE	K226	5K48TN2182	✓	\$473	F1	8.9-8.2/4.1	36	12.61	68,18

Refrigeration Fan, PSC, Open Air Over Resilient Ring & Thru-Bolt Mount

Features:

- Open end bracket
- Ball Bearings
- Automatic reset thermal protector
- BX connector included in frame (except on Catalog # X262)
- Catalog # X263 and X264 have 12" cord and molded plug
- UL Recognized and CSA Certified
- Capacitor included (except on Catalog # X262 and X426)



HP	RPM	VOLTS	FRAME	CAT. NO.	MODEL NO.	STOCK	LIST PRICE	MULT. SYMB.	F.L. AMPS	WEIGHT	FRAME LENGTH	"C" DIM.	FOOT NOTES
1/6	1625	208-230	48Y	X269	048A17O147	✓	\$201	F1	1.2	11	5.00	1/2 x 1 1/2	1
1/4	1625	208-230	48Y	X270	048A17O149	✓	\$216	F1	1.9	12	5.69	1/2 x 2 1/2	1
	1075	460	48Y	X264	048A11O11040		\$176	F1	0.8	13	3.20	1/2 x 3 3/4	16
	1075	208-230	48Y	X263	048A11O11041		\$173	F1	2.0	13	4.25	1/2 X 3 3/4	16
	1075	208-230	48Y	X262	048A11D245	✓	\$182	F1	1.8	15	7.25	1/2 x 1 5/8	67,69,82
1/3	1625	208-230	48YZ	X230	048A17O136	✓	\$181	F1	1.8	14	5.69	1/2 x 3 1/2	15
	1075	208-230	48YZ	X268	048A11O1239	✓	\$221	F1	3.0	14	5.69	1/2 x 2 1/2	15
3/4	1075	460	48YZ	X426	048A11O1375	✓	\$270	F1	2.2	19	6.38	5/8 X 4 1/2 w/key	67,69

Refrigeration Fan Motors, Three Phase Open Air Over, Shaft Up & Horizontal Rigid Base Mount

Applications:

Replacement motor for refrigeration equipment.

Features:

- 70°C ambient
- Enclosed shaft end bracket, vented frame
- Continuous duty
- Automatic reset thermal protector
- Shaft slinger
- Threaded lead exit
- Nameplated 60/50 hertz 190/380 volts, at next lower HP
- Double sealed ball bearings
- Flat and keyway on shaft
- Patented VCD, Voltage Change Device
- Ball Bearings
- UL Recognized and CSA Certified



X507 (Footless)

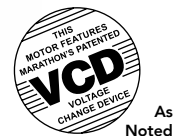

HP	RPM	VOLTS	FRAME	CAT. NO.	MODEL NO.	STOCK	LIST PRICE	MULT. SYMB.	F.L. AMPS	WEIGHT	FRAME LENGTH	"C" DIM.	FOOT NOTES
1/2	850	208-230/460	56HZ	X529	056T8O5531	✓	\$547	F1	2.9-3.0/1.5	31	9.62	5/8 x 5	VC,5
1	850	208-230/460	56HZ	X528	056T8O5306	✓	\$614	F1	5.1-5.3/2.65	49	10.62	5/8 x 5	VC,5
	850	208-230/460	56Y	X507	056T8O5302	✓	\$597	F1	5.3-5.3/2.6	46	12.00	5/8 x 5	VC
	850	575	56Y	K1511	5K48WN3181S	✓	\$563	F1	2.0	44	10.77	5/8 X 6	
1 1/2	1140	208-230/460	56HZ	X523	056T11O5306	✓	\$501	F1	5.45-5.4/2.7	36	11.00	5/8 x 5	VC,5
	850	208-230/460	56HZ	X531	056T8O15504	✓	\$668	F1	7.0-7.0/3.5	47	11.50	5/8 x 5	VC,5
2	1140	208-230/460	56HZ	X525	056T11O5310	✓	\$543	F1	7.2-6.8/3.4	47	12.00	5/8 x 5	VC,54

Transformer Cooling Fan Replacement

TEAO, Single Speed, Rigid Base

Features:

- External cooling air required
- Reversible rotation
- Ball Bearings
- Optional extended clamp screws
- Z shaft is .50 x 2.25" with 1.91" Flat



Single Phase

HP	RPM	VOLTS	FRAME	CAT. NO.	MODEL NO.	STOCK	LIST PRICE	MULT. SYMB.	F.L. AMPS	WEIGHT	"C" DIM.	FOOT NOTES
1/20	1625	115/200-230	48Z	PG240	5KCP35CNA490S	✓	\$327	F1	1.5/.07-0.8	12	10.32	9,25,50,94,113
1/3	1075	115/200-230	56Z	P241	5KCP36RNA491S	✓	\$413	F1	4.4/2.1-2.2	21	10.75	9,25,50,94,113

Three Phase

HP	RPM	VOLTS	FRAME	CAT. NO.	MODEL NO.	STOCK	LIST PRICE	MULT. SYMB.	F.L. AMPS	WEIGHT	"C" DIM.	FOOT NOTES
1/3	1200	200-230/460	56	K1487	5K49MN6126T	✓	\$579	F1	2.1-2.0/1.0	27	10.38	68,113

Unit Heater Fan, PSC, TEAO

Resilient Base

Applications:

Replacement motors for unit heaters. Air over motors need to be mounted within the airstream for proper cooling.



Features:

- Totally enclosed
- Direct drive, air over
- Ball Bearings
- Horizontal or vertical mount
- Weather resistant reversing plug
- BX connector mounted in frame
- 1" Extended thru-bolts
- 48Y Frame has non-standard BA dimension
- Automatic reset thermal protection
- UL Recognized and CSA Certified
- Capacitor included

HP	RPM	VOLTS	FRAME	CAT. NO.	MODEL NO.	STOCK	LIST PRICE	MULT. SYMB.	F.L. AMPS	WEIGHT	FRAME LENGTH	"C" DIM.	FOOT NOTES
1/6	1625	115	48Y	X305	48A17T2001	✓	\$164	F1	2.0	13	4 3/4	1/2 x 2 3/4	
	1625	115	48Y	X301	48A17T72	✓	\$146	F1	2.0	13	5 1/4	1/2 x 2 3/4	
	1075	115	48Y	X302	48A11T199	✓	\$170	F1	3.0	13	4 3/4	1/2 x 2 3/4	
1/4	1075	115	48Y	X303	48A11T198	✓	\$178	F1	4.1	14	4 3/4	1/2 x 2 3/4	
1/3	1075	115	48Y	X304	48A11T201	✓	\$197	F1	6.5	21	21	1/2 x 2 3/4	

Circulator Pump, Split Phase

Dripproof, Resilient Ring

Applications:

Direct replacements for Taco hot water circulators.

Features:

- Quiet sleeve bearing construction
- 48Z frame with 1/2" diameter shaft, 1" long without flat
- 1.40 Service Factor (except as noted)
- Fixed CCW rotation, viewed opposite shaft end
- 4722 replaces Taco No. 110-388, Marathon No. 48S17D1027, 48S17D2102
- 4404 replaces GE No. 5KH32EG129GA, Marathon No. 48S17D1084
- UL Recognized and CSA Certified



HP	RPM	VOLTS	FRAME	CAT. NO.	MODEL NO.	STOCK	LIST PRICE	MULT. SYMB.	F.L. AMPS	WEIGHT	"C" DIM.	FOOT NOTES
1/12	1800	115	48Y	4722	5KH39QN5558T	✓	\$116	F1	2.1	12	7.29	
1/8	1800	115	48Y	4404	5KH39QN5550X	✓	\$126	F1	2.6	11	8.93	
1/4	1800	115	48Y	HG716	5KH36DNA780X		\$277	F1	5.7	12	9.01	4,17
1/3	1800	115	48Y	HG717	5KH37GNA782X		\$296	F1	6.2	14	9.41	4,17

ME-CAN-DO Multi-Horsepower Motors

The new Marathon Motors "Me-Can-Do" line of motors is a Multi-horsepower motor that replaces many different ratings.

Here are some of the advantages of the ME-Can-Do motor:

1. Saves money! Eliminates unnecessary inventory on shelves or in repair trucks.
2. Saves time! No more long drives for replacement motors. No more late hour or emergency shop openings.
3. This motor "Can Do" the job the first time! Offers multiple options in just one motor, no need for temporary substitutions.

Here are some of the motors that the ME-Can-Do motors replaces today:

Condenser Fan Motors

MARATHON	EMERSON	Century (A.O. Smith)
X072	5462	FSE6000
X076	5465	FE6002

Direct Drive Fan and Blower Motors

MARATHON	EMERSON	Century (A.O. Smith)
X033	5460	FDL6001
X073	5461	FD6000
X074	5470	FDL6002
X075	5471	FD6001

ME-CAN-DO Multi-Horsepower Condenser Fan, PSC, TEAO, Thru-Bolt

Applications:

Direct drive fans for shaft up or horizontal mount. These motors need to be mounted within the airflow of the fan for proper cooling.

Features:

- Ball Bearings
- 60°C ambient
- Automatic reset thermal protector
- Weather resistant reversing plug
- Reversible by reconnection
- 36" long leads
- Extended thru-bolts, 8-32 1/2" on drive end, 3/4" on non-drive end
- Shaft slinger
- Four Locating screws on frame, 90° apart
- 1/2" x 5" long shaft with two flats 4.50" 90° apart
- UL Recognized and CSA Certified
- Capacitor not included, see Accessories section



HP	RPM	VOLTS	FRAME	CAPACITOR (MFD)	SPEED RANGE	CAT. NO.	MODEL NO.	STOCK	LIST PRICE	MULT. SYMB.	WEIGHT	F.L. AMPS	FRAME LENGTH
1/3		230		5.0	HI							2.3	
1/3		208		7.5	HI							2.3	
1/4		230		5.0	HI							2.0	
1/4	1075/2	208	48Y	7.5	HI	X072	48A11T646	✓	\$191	F1	14	2.0	5 1/2
1/5		230		5.0	LO							1.4	
1/5		208		7.5	LO							1.4	
1/6		230		5.0	LO							1.2	
1/6		208		7.5	LO							1.2	
1/2		230		10.0	HI							2.5	
1/2		208		12.5	HI							2.6	
1/3		230		10.0	HI							2.1	
1/3	1075/2	208	48Y	12.5	HI	X076	48A11T11006	✓	\$205	F1	19	2.0	5 1/2
1/4		230		10.0	LO							1.4	
1/4		208		12.5	LO							1.4	
1/5		230		10.0	LO							1.2	
1/5		208		12.5	LO							1.2	

ME-CAN-DO Multi-Horsepower Fan & Blower - Direct Drive, PSC, Open Air Over Resilient Ring, Thru-Bolt

Applications:

Residential and commercial furnaces, air conditioners, exhaust fans, and other air handling equipment installed in clean and dry environments.

Features:

- Open end brackets
- 2 1/4" Resilient rings
- 1/2" x 5" long shaft with two flats 4.50" 90O apart
- Automatic reset thermal protector
- Weather resistant reversing plug
- Reversible by reconnection
- 36" long leads
- Extended thru-bolts, 8-32 1/2" on drive end, 3/4" on non-drive end
- UL Recognized and CSA Certified
- Capacitor not included, see Accessories section
- Ball Bearings



HP	RPM	VOLTS	FRAME	CAPACITOR (MFD)	SPEED RANGE	CAT. NO.	MODEL NO.	STOCK	LIST PRICE	MULT. SYMB.	WEIGHT	F.L. AMPS	FRAME LENGTH
1/2				10.0	ALL							6.1	
1/3				5.0	ALL							5.2	
1/3				7.5	ALL							4.7	
1/4				5.0	MED-HI							3.6	
1/4	1075/4	115	48Y	7.5	MED-LO, LO	X077	48A11O11066	√	\$145	F1	15	3.2	5
1/5				5.0	MED-LO							2.8	
1/5				7.5	LO							2.5	
1/6				5.0	LO							2.4	
1/6				7.5	LO							2.0	
1/2				10.0	ALL							2.7	
1/3				5.0	ALL							2.3	
1/3				7.5	ALL							2.1	
1/4				5.0	MED-HI							1.6	
1/4	1075/4	208-230	48Y	7.5	MED-LO, LO	X073	48A11O11064	√	\$149	F1	14	1.4	4 3/4
1/5				5.0	MED-LO							1.3	
1/5				7.5	LO							1.1	
1/6				5.0	LO							1.1	
1/6				7.5	LO							0.9	
3/4				20.0	ALL							7.8	
1/2				10.0	ALL							7.1	
1/3	1075/4	115	48Y	10.0	MED-HI, MED-LO, LO	X074	48A11O11042	√	\$173	F1	22	4.9	6
1/4				10.0	MED-LO, LO							3.7	
1/5				10.0	LO							2.9	
3/4				20.0	HI							3.8	
1/2				20.0	MED-HI							2.7	
1/2				10.0	HI							3.7	
1/3	1075/4	208-230	48Y	20.0	MED-LO	X075	48A11O11063	√	\$185	F1	22	1.9	6
1/3				10.0	MED-HI							2.8	
1/4				20.0	LO							1.4	
1/4				10.0	MED-LO							2.6	
1/5				10.0	LO							1.6	

OEM: Carrier

PSC, Open Air Over

Features:

- Ball Bearings
- Multi-speed capability, as noted
- Resilient ring/belly band mount
- X236 Replaces Carrier Nos. HC41SE117, P251-2306 & -2307
- X237 Replaces Carrier Nos. HC41SE651, HC39SE651, P251-5306, & P251-5408
- X203 Replaces Carrier No. HC44AL230, Fasco No. D804, & Magnetek No. 655
- X241 Replaces Carrier Nos. HC45SE651 & P251-5701
- X242 Replaces Carrier Nos. HC52AL230, 231, & 232 HC52SE208, P251-5101 & -5102
- Capacitor not included, see Accessories section



HP	RPM	VOLTS	FRAME	CAT. NO.	MODEL NO.	STOCK	LIST PRICE	MULT. SYMB.	F.L. AMPS	WEIGHT	FRAME LENGTH	SHAFT DIM.	FOOT NOTES
1/3	1075/4	115	48Y	X236	48A11O699	✓	\$173	F1	6.4	16	4 3/4	1/2x6	
	1075/4	208-230	48Y	X237	48A11O694		\$176	F1	4.8	16	5 1/4	1/2x6	
1/2	1075	208-230	48Y	X203	48A11O1062	✓	\$216	F1	5.3	19	6 1/2	1/2 x 5 1/2	16
3/4	1075/4	208-230	48Y	X241	48A11O697	✓	\$223	F1	5.4	17	5 1/2	1/2x6	
1	1000/3	208-230	48YZ	X242	48A11O756	✓	\$377	F1	6.2	26	7 1/4	5/8x4	51,68

Replacements listed may not be an exact duplicate of the original motor

OEM: Carrier

PSC, Open Air Over

Features:

- Single and multi-speed models, as noted
- 3 lug mounting
- X223 Replaces Carrier No. HC37VE230 & Fasco No. D842
- X273 Replaces Carrier No. HC37ME268, Fasco No. D844, Century (A.O. Smith) No. OCA1024, & Magnetek No. 624
- X210 Replaces Carrier Nos. HC37MZ220, HC39VE608, HC39ML706, HC37ME720, HC37ML702
- X210 Replaces Emerson No. 3303, Fasco No. D843, Magnetek No. 514, & Century (A.O. Smith) No. OCB1026
- X222 Replaces Carrier Nos. HC41VE700 & 701, Emerson No. 3225, Magnetek No. 536, & Century (A.O. Smith) No. OCB1036
- X405 Replaces Century (A.O. Smith) No. OCA1056
- Ball bearings (except as noted)
- Capacitor not included, see Accessories section

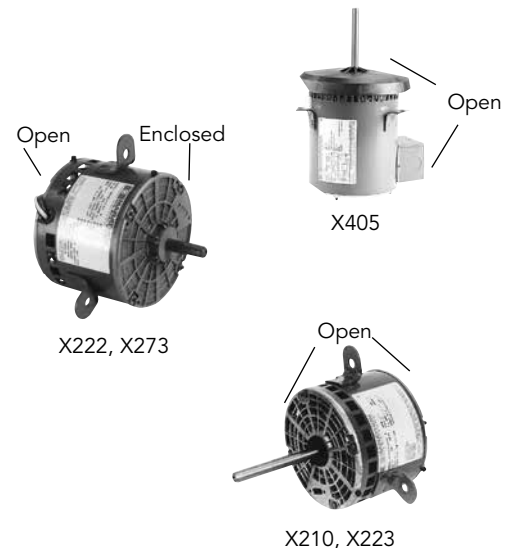

HP	RPM	VOLTS	FRAME	CAT. NO.	MODEL NO.	STOCK	LIST PRICE	MULT. SYMB.	F.L. AMPS	WEIGHT	FRAME LENGTH	SHAFT DIM.	FOOT NOTES
1/5	1075/1	230	48Y	X223	48A11O2050		\$146	F1	1.3	10	3 3/4	1/2 x 2 3/4	16
1/4	1625/1	230	48Y	X273	48A17O161		\$137	F1	1.5	12	4 1/4	1/2 x 1 5/8	16
	1075/2	208-230	48Y	X210	48A11O1068	✓	\$146	F1	2.2	13	4 1/8	1/2 x 4 1/4	
1/3	1075/2	230	48Y	X222	48A11O1109	✓	\$182	F1	2.6	15	4 3/4	1/2 x 3	
1/2	1075/1	208-230/460	48Y	X405	48A11O1744	✓	\$237	F1	3.6/1.8	25	6 7/8	1/2 x 4	21

OEM: Carrier

Three Phase, Open Air Over

Features:

- Ball Bearings
- X235 is 70°C ambient
- Ball Bearings
- X235 replaces Carrier No. HD52VE214 & Marathon No. 56T11D33
- X251 replaces Carrier No. HD60AZ660 & Marathon No. 56T34D903



X235



X251

HP	RPM	VOLTS	FRAME	CAT. NO.	MODEL NO.	STOCK	LIST PRICE	MULT. SYMB.	F.L. AMPS	WEIGHT	FRAME LENGTH	SHAFT DIM.	FOOT NOTES
1	1140	200-230/460	56Y	X235	56T11D5209	✓	\$469	F1	6.6-6.0/3.0	36	10 1/2	5/8 x 2 7/8	
5	3600	208-230/460	56HZ	X251	56T34D5364	✓	\$654	F1	13.5-12.4/6.2	50	13.49	7/8 x 2 1/4	Z,5

Replacements listed may not be an exact duplicate of the original motor

OEM: Evans/Armstrong/LSI Home

PSC, Open Air Over

Features:

- Resilient ring thru-bolt mounting
- Replaces Fasco No. D825 & GE No. 5KCP35G644S
- Ball bearings
- Capacitor not included, see Accessories section

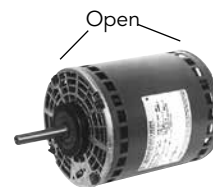

HP	RPM	VOLTS	FRAME	CAT. NO.	MODEL NO.	STOCK	LIST PRICE	MULT. SYMB.	F.L. AMPS	WEIGHT	FRAME LENGTH	FOOT NOTES
1	1625/2	208-230	48Y	X211	48A17O125	✓	\$248	F1	6.2	20	6 1/4	1/2 x 2 1/2

OEM: Greenheck Fan

PSC, Open Air Over

Features:

- Thru-bolt mounting
- Automatic reset thermal protector
- Internal cooling fan
- X261 replaces Greenheck No. 300008
- X260 replaces Greenheck No. 300010
- Ball bearings
- Capacitor included



HP	RPM	VOLTS	FRAME	CAT. NO.	MODEL NO.	STOCK	LIST PRICE	MULT. SYMB.	F.L. AMPS	WEIGHT	FRAME LENGTH	FOOT NOTES
1/8	825	115	48Y	X261	48A8O151	✓	\$195	F1	2.1	13	5 1/2	1/2 X 2 1/2
1/6	1140	115	48Y	X260	48A11O251	✓	\$185	F1	2.2	13	5 1/4	1/2 X 2 1/2

Replacements listed may not be an exact duplicate of the original motor

OEM: Hill Refrigeration

PSC, Open Air Over

Features:

- Resilient base
- Replaces Magnetek No. 160, Stevco No. S3001, Fasco No., D801, GE No. 5KCP39KG1369S
- Ball bearings
- Capacitor included

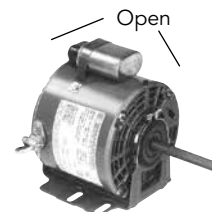

HP	RPM	VOLTS	FRAME	CAT. NO.	MODEL NO.	STOCK	LIST PRICE	MULT. SYMB.	F.L. AMPS	WEIGHT	FRAME LENGTH	SHAFT DIM.	FOOT NOTES
1/3	1625	208-230	48Y	X230	48A17O136	✓	\$181	F1	1.8	14	4 3/4	1/2x3 1/2	15

OEM: Huebsch

Single Phase, Dripproof, Resilient Base

Applications:

Commercial laundry dryer motors.



Features:

- Replaces Huebsch commercial laundry dryer motors
- Automatic reset thermal protection
- Special threaded shaft extension
- X602 has 3/4" shaft adapter included
- Ball bearings
- 48YZ have 48/56 Fr. mounting holes

HP	RPM	VOLTS	FRAME	CAT. NO.	MODEL NO.	STOCK	LIST PRICE	MULT. SYMB.	F.L. AMPS	WEIGHT	"C" DIM.	FOOT NOTES
1/4	1725	100-120/200-240	48YZ	X600	48C17D2057		\$239	F1	5.4-6.6/2.7-3.3	18	12.02	16,68
1/3	1725	115/208-230	56Z	X601	56C17D2101	√	\$283	F1	5.8/2.8-2.9	20	14.41	16
1/2	1725	115/208-230	56Z	X602	56C17D2102	√	\$348	F1	8.0/4.0-4.0	24	15.41	16
3/4	1725	115/208-230	56Z	X603	56C17D5346	√	\$439	F1	12.0/5.8-6.0	29	15.10	16

OEM: Hussman Refrigeration

PSC, Open Air Over

Features:

- Thru-bolt mounting
- Replaces Fasco No. D807, GE No. 5KCP39EGC2447, Magnetek No. 174, Emerson No. 1645
- Ball bearings
- Capacitor included

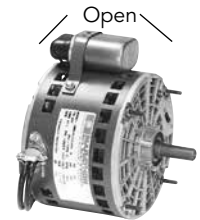

HP	RPM	VOLTS	FRAME	CAT. NO.	MODEL NO.	STOCK	LIST PRICE	MULT. SYMB.	F.L. AMPS	WEIGHT	FRAME LENGTH	SHAFT DIM.	FOOT NOTES
1/6	1625	208-230	48Y	X269	48A17O147	√	\$201	F1	1.2	11	4 1/8	1/2 x 1 1/2	15

OEM: Liebert

Three Phase, Resilient Base

Features:

- Replaces GE 5K36PN294S
- Ball bearings

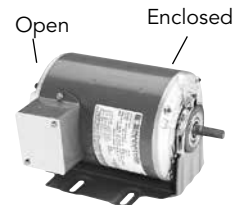

HP	RPM	VOLTS	FRAME	CAT. NO.	MODEL NO.	STOCK	LIST PRICE	MULT. SYMB.	F.L. AMPS	WEIGHT	FRAME LENGTH	SHAFT DIM.	FOOT NOTES
1/3	1140	208-230/460	48Y	X259	56T11O15	√	\$249	F1	1.9-1.8/9	29	10.06	1/2x1 1/2	15

Replacements listed may not be an exact duplicate of the original motor

OEM: Lennox

PSC, Totally Enclosed & Open Air Over

Features:

- X411 replaces Lennox No. 47F9901, Magnetek No. 9402, & Marathon Nos. 48A11T300 & 48A11T247
- X209 replaces Fasco No. D2817 & GE No. 5KCP39PG9701S, open/air over
- X236 replaces Lennox No. P-8-7505, Magnetek No. 565, Century (A.O. Smith) No. OLE1036, & Fasco No. D812, open/air over
- X281 replaces Lennox No. P-8-2702, Fasco No. D814, GE No. 5KCP39GGA124S, & Emerson No. 8054, open/air over
- Ball Bearings
- Capacitor not included, see Accessories section

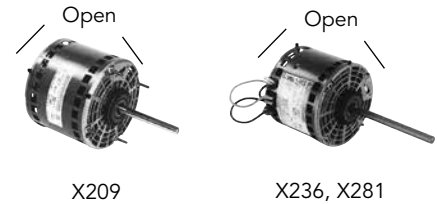
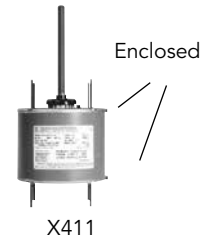

OEM REPLACEMENTS

HP	RPM	VOLTS	FRAME	CAT. NO.	MODEL NO.	STOCK	LIST PRICE	MULT. SYMB.	F.L. AMPS	WEIGHT	FRAME LENGTH	SHAFT DIM.	FOOT NOTES
1/6	1075/1	208-230	48Y	X411	48A11T2008	✓	\$152	F1	1.3	10	3 3/4	1/2 x 6	
1/3	825/1	230	48Y	X209	48A8O183	✓	\$190	F1	3.0	17	5 3/4	1/2 x 5 1/2	34,50
	1075/4	115	48Y	X236	48A11O699	✓	\$173	F1	6.4	16	4 3/4	1/2 x 6	39

OEM: Rheem / Ruud

PSC, Totally Enclosed & Open Air Over

Features:

- X278 Replaces Rheem Nos. 21276-02, 21276-01, 51207-01 & Fasco No. D832
- X216 Replaces Emerson No. 5454 & Magnetek No. 619
- X470 Replaces Rheem / Ruud condenser fans
- X297 Replaces Century (A.O. Smith) No. ORM1036, Magnetek 620, & Fasco No. D2834
- X033 Replaces Rheem Time-Savers, Emerson No. K55HXMDA-4122, & Rheem / Ruud No. 51-23012-41
- Ball Bearings
- Capacitor not included, see Accessories section

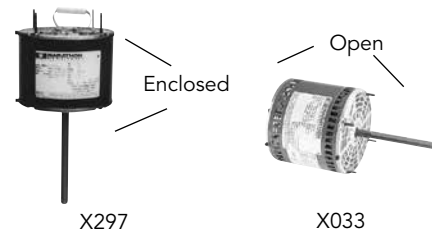
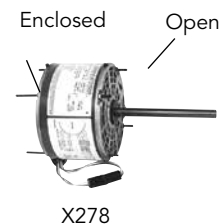

HP	RPM	VOLTS	FRAME	CAT. NO.	MODEL NO.	STOCK	LIST PRICE	MULT. SYMB.	F.L. AMPS	WEIGHT	FRAME LENGTH	SHAFT DIM.	FOOT NOTES
1/8	825/1	208-230	48Y	X278	48A8O206	✓	\$181	F1	.9	11	4 1/4	1/2 x 4 3/4	37,44
1/5	1075/1	208-230	48Y	X216	48A11O1097	✓	\$133	F1	1.6	10	3 3/4	1/2 x 6	37,44,60
1/4	1075/1	208-230	48Y	X470	48A11O885	✓	\$140	F1	1.6	9	3 3/4	1/2 x 3	56,60
1/3	1075/1	208-230	48Y	X297	48A11T509	✓	\$141	F1	1.8	12	4 1/4	1/2 x 3 3/4	N,29,41,60
1/2	1075/4	115	48Y	X033	48A11O1674	✓	\$145	F1	6.1	16	5	1/2 x 5	31

Replacements listed may not be an exact duplicate of the original motor

OEM: Sears/Whirlpool

PSC, Open Air Over

Features:

- X215 replaces Delco inside out window a/c, Fasco No. D857, Century (A.O. Smith) No.OWL1006, & Emerson No. 1142
- X212 replaces Delco inside out window a/c, Fasco No. D858, & Century (A.O. Smith) No. OWR1016
- X200 replaces Delco inside out window a/c, Fasco No. D859, Emerson No. 855, & Century (A.O. Smith) No. OWR1036
- X218 replaces Steveco Package unit 3100
- Single Split Phase, Open Air Over
- Capacitor not included, see Accessories section

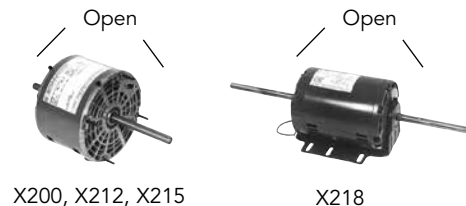

HP	RPM	VOLTS	FRAME	CAT. NO.	MODEL NO.	STOCK	LIST PRICE	MULT. SYMB.	F.L. AMPS	WEIGHT	FRAME LENGTH	SHAFT DIM.	FOOT NOTES
1/8	1100/3	115	48Y	X215	48A11O1081		\$145	F1	1.7	10	3 7/8	4 x 1/2 x 2 3/4	4,16
1/6	1100/3	230	48Y	X212	48A11O1065		\$145	F1	1.1	11	3 7/8	4 x 1/2 x 2 3/4	16
1/3	1100/3	230	48Y	X200	48A11O1060		\$147	F1	1.7	12	4 1/3	6 x 1/2 x 4	4,16
3/4	1075/1	208-230	56Z	X218	56A11O5313	✓	\$385	F1	3.9-3.6	34	8 5/8	7 x 5/8 x 7	16,21

OEM: Taco

Single Split Phase, Open Air Over

Features:

- Resilient ring mounting
- 4722 replaces Taco No. 110-388, Marathon No. 48S17D1027, 48S17D2102
- 4404 replaces GE No. 5KH32EG129GA, Marathon No. 48S17D1084
- UL Recognized and CSA Certified

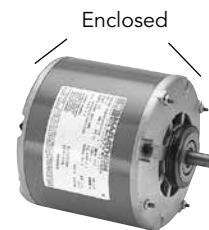

HP	RPM	VOLTS	FRAME	CAT. NO.	MODEL NO.	STOCK	LIST PRICE	MULT. SYMB.	F.L. AMPS	WEIGHT	FRAME LENGTH	SHAFT DIM.	FOOT NOTES
1/12	1800	115	48Y	4722	5KH39QN5558T	✓	\$116	F1	2.1	12	7.29	1/2 x 1	
1/8	1800	115	48Y	4404	5KH39QN5550X	✓	\$126	F1	2.6	11	8.93	1/2 x 1 1/2	

OEM: Tyler

PSC, Open Air Over

Features:

- Resilient ring thru-bolt mounting
- Replaces Tyler No. 760, Fasco No. D870, & Century (A.O. Smith) No. OTY1024
- Ball bearings
- Capacitor included

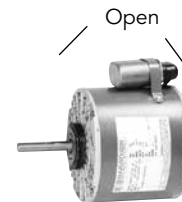

HP	RPM	VOLTS	FRAME	CAT. NO.	MODEL NO.	STOCK	LIST PRICE	MULT. SYMB.	F.L. AMPS	WEIGHT	FRAME LENGTH	SHAFT DIM.	FOOT NOTES
1/4	1625/1	208-230	48Y	X270	48A17O149	✓	\$216	F1	1.9	12	4 3/4	1/2 x 2 1/2	16

Replacements listed may not be an exact duplicate of the original motor

OEM: Warren PSC, Open Air Over

Features:

- Resilient ring mounting
- Ball bearings
- Capacitor included

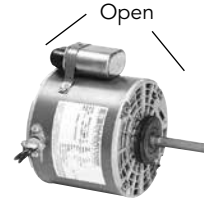

HP	RPM	VOLTS	FRAME	CAT. NO.	MODEL NO.	STOCK	LIST PRICE	MULT. SYMB.	F.L. AMPS	WEIGHT	FRAME LENGTH	SHAFT DIM.	FOOT NOTES
1/3	1075/1	208-230	48Y	X268	48A11O1239	√	\$221	F1	3.0	14	4 3/4	1/2 x 2 7/8	15

OEM: York PSC, Open Air Over

Features:

- Round belly band mounting
- Replaces York No. K44HXJAF-4955 & Fasco No. D873, Century (A.O. Smith) No. OYK1056, Magnetek No. 468
- Ball bearings
- Capacitor not included, see Accessories section

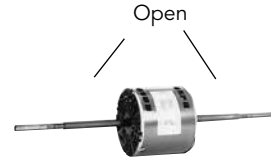

HP	RPM	VOLTS	FRAME	CAT. NO.	MODEL NO.	STOCK	LIST PRICE	MULT. SYMB.	F.L. AMPS	WEIGHT	FRAME LENGTH	SHAFT DIM.	FOOT NOTES
1/2	1050	230	48Y	X295	48A11O1410	√	\$197	F1	3.9	19	5	9 1/4x1/2x9 1/8	15

Pedestal Fan, PSC, TEAO 48 Frame, Yoke Mount

Features:

- Heavy gauge steel frame and yoke fan shroud mounted by four 7/8" extended stud bolts on 5-1/8" bolt circle
- Single and multi-speed models as noted
- Automatic reset thermal protector
- 1/2" x 2-1/2" long shaft with two flats, 90° apart
- 1.0 Service Factor
- Ball bearings (except as noted)
- Capacitor included
- UL Recognized and CSA Certified



HP	RPM	VOLTS	FRAME	CAT. NO.	MODEL NO.	STOCK	LIST PRICE	MULT. SYMB.	F.L. AMPS	WEIGHT	FRAME LENGTH	SHAFT DIM.	FOOT NOTES
1/4	1625/1	115/230	48Z	X920	48A17T2005	√	\$203	F1	3.6/1.8	22	7.3	10.56	17
	1075/2	115	48Z	X923	48A11T2024	√	\$237	F1	3.2	18	6.5	9.81	17
1/3	1625/1	115/230	48Z	X921	48A17T2006	√	\$221	F1	3.8/1.9	24	7.8	11.06	17
	1075/2	115	48Z	X924	48A11T2025	√	\$256	F1	4.2	19	6.5	9.81	17
1/2	1625/1	115/230	48Z	X922	48A17T2007	√	\$244	F1	5.4/2.7	27	8.0	11.31	17
	1075/2	115	48Z	X925	48A11T2026	√	\$285	F1	5.7	25	7.5	10.81	17

Replacements listed may not be an exact duplicate of the original motor

Aggregate Duty - Blue Chip® Crusher

Totally Enclosed, Three Phase, Rigid Base, High Torque



IP55



Applications:

Specifically designed for the aggregate industry crusher applications such as cone, jaw, and roller type impactors, pulverizers, etc.

Features:

- Blue Chip® quality, 100% cast iron construction for rigidity and reduced vibration
- NEMA Design C
- 4140 Shaft Material
- Roller Bearing on Drive End for belted loads
- 1.15 Service Factor
- 80C rise at rated load
- Class F insulation
- Inpro® Smart Ring, rotating shaft seals on each end of shaft
- Internal and external epoxy paint
- Brass drain and breather
- Actual test and vibration data supplied with each motor

Suitable for use on VFD per guidelines on page 17.

HP	RPM	VOLTS	FRAME	CAT. NO.	MODEL NO.	STOCK	LIST PRICE	MULT. SYMB.	NOM. EFF.	F.L. AMPS	WEIGHT	"C" DIM.	FOOT NOTES
100	1800	460	405T	Y822A	405TTFS14554	✓	\$8,519	E4	94.5	117	1318	37.14	YD
125	1800	460	444T	Y824	444TTFS8841	✓	\$11,565	E4	94.5	142	1695	41.25	YD
150	1800	460	445T	Y826A	445TTFN14571	✓	\$12,679	E4	95.0	174	1990	43.35	YD
200	1800	460	449T	Y855A	449TTFS14584	✓	\$18,934	E4	95.0	245	3098	51.75	YD
250	1800	460	449T	Y857	449TTFS8581	✓	\$23,270	E4	95.4	304	3242	51.84	YD

Catalog numbers (Cat No.) highlighted in bold blue have efficiency levels that meet EISA requirements

Blue shaded areas are Cast Iron Frames

Air Compressor, Single Phase

Dripproof, Rigid Base

Features:

- Capacitor start / capacitor run design for low amps and high efficiency, as noted
- High starting and breakdown torque
- Heavy gauge steel frame and base
- Continuous duty at nameplate ratings
- Thermal protection, as noted
- UL Recognized and CSA Certified



HP	RPM	VOLTS	FRAME	OVER LOAD	CAT. NO.	MODEL NO.	STOCK	LIST PRICE	MULT. SYMB.	F.L. AMPS	WEIGHT	"C" DIM.	FOOT NOTES
1/2	3600	115	56	MANUAL	9031	5KC49MN2043Y	✓	\$215	F1	11.5	20	11.14	2,17
	1800	115/208-230	56	MANUAL	C169	5KC49GN0010Y	✓	\$284	F1	8.8/4.4	21	10.38	2
3/4	3600	115	56	MANUAL	9032	5KC49MN2049Y	✓	\$250	F1	12.5	27	11.14	2,17
	1800	115/208-230	56	MANUAL	K016	56B17D56	✓	\$348	F1	11.0/5.5	25	11.47	1
1	3600	115/230	56	MANUAL	9033	5KC49NN2050Y	✓	\$285	F1	16.0/8.0	23	11.14	d,2,17
	3600	115/208-230	56	MANUAL	D010	56B34D2029	✓	\$287	F1	10.6/5.5-5.3	23	11.72	1
	1800	115/208-230	56	MANUAL	C1480	5KC49PN0161U	✓	\$379	F1	13.6/6.8	31	11.38	2
1 1/2	3600	115/208-230	56	MANUAL	C704	5KC49PN2521Y	✓	\$369	F1	21.3/10.6	31	11.91	2,18
	1800	115/208-230	56H	MANUAL	G951	56C17D5308	✓	\$443	F1	18.0/9.3-9.0	39	12.44	2,5,7
2	3600	115/208-230	56H	MANUAL	9035	5KCR48TN2650Y	✓	\$464	F1	15.0/7.5	38	11.14	ES,1,17,48
	1800	115/208-230	145T	MANUAL	I127	145TBDR5337	✓	\$534	S1	18.8/10.2-9.4	48	13.49	1,7

Continued on next page.

Air Compressor, Single Phase

Dripproof, Rigid Base

HP	RPM	VOLTS	FRAME	OVER LOAD	CAT. NO.	MODEL NO.	STOCK	LIST PRICE	MULT. SYMB.	F.L. AMPS	WEIGHT	"C" DIM.	FOOT NOTES
3	3600	230	56H	MANUAL	9036	5KCR48UN2653Y	✓	\$602	F1	15.0	40	11.44	ES,1,17,48
	1800	230	184T	NONE	Z502	184TBDR5326	✓	\$559	S1	12.6	51	14.27	1
SPCL	3600	230	56	MANUAL	9040	5KCR48UN2654Y	✓	\$542	F1	15.0	40	12.1	ES,1
5	3600	230	56H	MANUAL	9038B	5KCR49ZN2722Y	✓	\$644	F1	21.0	49	15.04	ES,1,5,17,48
	3600	230	56H	MANUAL	D017	56B34D5302	✓	\$640	F1	20.0	55	13.94	1,5
	3600	230	184T	NONE	Z504	184TBDR5301		\$785	S1	20.0	62	14.77	1
	1800	208-230	184T	MANUAL	I119	184TBDR7375		\$891	S1	25.0-24.1	83	16.22	1,13
	1800	208-230	184T	NONE	I114A	184TBDW7026	✓	\$686	S1	23.0-21.0	82	14.69	1,13
7 1/2	1800	208-230	184T	NONE	Z506A	184TBDW7656		\$672	S1	22.0-20.0	81	15.21	1,13
	3600	208-230	184T	NONE	I108A	184TBDW7001	✓	\$770	S1	34.3-31.0	103	16.69	1,13
	3600	208-230	213T	NONE	I105	213TCDW7001	✓	\$1,047	S1	40.0-37.0	102	16.55	2,F
	1800	208-230	215T	NONE	I115	215TBDW7026	✓	\$1,027	S1	37.2-34.5	115	18.05	1
10	1800	208-230	215T	NONE	I116	215TBDW7028	✓	\$1,322	S1	49.0-44.0	140	19.3	1

Cooling Tower: Two-Speed-One Winding, Variable Torque Blue Chip® Severe Duty, XRI®

Three Phase, Totally Enclosed, Rigid Base

Applications:

Cooling towers, Fan and Blowers, and other severe duty environments where long life and ultra-high efficiency are desired. Guaranteed efficiencies offer an eXtra Return on your Investment when using these premium efficiency motors on high cycle or long run applications. Replacement for two-speed Marley cooling tower motors.



IP55

Features:

- Blue Chip® quality, 100% cast iron construction for rigidity and reduced vibration
- Internal and external epoxy paint
- Class F insulation
- 1.15 Service Factor
- Extended grease tubes, regreasable in service
- T-drains provided for effective drainage (Installed in both endshields)
- Shaft Slinger
- Forsheda seals on both ends
- Actual test and vibration data supplied with each motor
- Ball Bearings
- UL Recognized and CSA Certified
- Three year warranty
- Horizontal mounting only; consult Engineering for Vertical mounting

HP	RPM	VOLTS	FRAME	CAT. NO.	MODEL NO.	STOCK	LIST PRICE	MULT. SYMB.	NOM. EFF.	F.L. AMPS	WEIGHT	"C" DIM.	FOOT NOTES
3/7.5	1800/900	460	184T	Y380	184TTFS7290		\$1,384	S3	85.5	4.0/1.75	141	16.19	2,17
5/1.25	1800/900	460	213T	Y381	213TTFS7238		\$1,530	S3	89.5	6.0/2.4	199	19.72	
7.5/1.9	1800/900	460	215T	Y382	215TTFS7290	✓	\$1,983	S3	89.5	9.0/3.1	142	19.72	
10/2.5	1800/900	460	254T	Y383	254TTFNA7210		\$2,390	S3	90.2	12.0/4.0	360	23.52	
15/3.75	1800/900	460	256T	Y384	256TTFNA7250	✓	\$2,985	S3	90.2	18.0/6.0	381	25.27	
20/5	1800/900	460	284T	Y385	284TTFNA7240	✓	\$3,725	S3	91.7	24.0/8.5	489	26.34	
25/6.25	1800/900	460	286T	Y386	286TTFNA7260	✓	\$4,347	S3	91.7	31.0/11.0	168	27.84	
30/7.5	1800/900	460	324T	Y387	324TTFS7290	✓	\$5,305	S3	91.0	35.0/11.2	668	28.87	
40/10	1800/900	460	326T	Y388	326TTFS9210	✓	\$6,630	S3	87.5	46.0/14.6	451	30.37	
50/13	1800/900	460	364T	Y389	364TTFS9234	✓	\$8,432	S3	92.4	61.0/24.0	958	31.50	
60/15	1800/900	460	365T	Y390	365TTFS9230	✓	\$12,204	S3	92.4	75.0/25.0	1000	32.50	
75/18.75	1800/900	460	405T	Y391	405TTFS7297		\$15,786	S3	94.1	83.0/27.0	1331	37.12	1
100/25	1800/900	460	444T	Y392	444TTFS7262		\$19,093	S3	94.1	113/37.5	1781	41.25	

Blue shaded areas are Cast Iron Frames

Multi-Speed: Two-Speed, One-Winding, Variable Torque

Three Phase, Dripproof, Rigid Base

Applications:

Commercial and industrial fans, blowers, pumps, and other machinery that have variable torque characteristics. Prolonged use at low speed can result in significant energy savings. Dripproof motors are intended for use in environments that are relatively clean and dry. For use outdoors an enclosure or drip cover may be required (see Accessories section).



Features:

- Ball Bearings
- 1.15 Service Factor
- UL Recognized and CSA Certified

HP	RPM	VOLTS	FRAME	CAT. NO.	MODEL NO.	STOCK	LIST PRICE	MULT. SYMB.	NOM. EFF.	F.L. AMPS	WEIGHT	"C" DIM.	FOOT NOTES
3/7.5	1800/900	200-230	182T	Y1484	182TTDW7412	✓	\$651	S3	82.7	8.8-3.8/8.0-3.6	65	14.19	F,13
	1800/900	460	182T	Y485A	182TTDW7203		\$651	S3	82.7	4.0/1.8	58	13.19	13,25
5/1.25	1800/900	200-230	184T	Y486A	184TTDW7287	✓	\$912	S3	85.5	14.5-13.8/5.6-6	40	14.19	F,13
	1800/900	460	184T	Y1487	184TTDW7209	✓	\$912	S3	85.5	6.9/3.0	80	14.72	13
7.5/1.88	1800/900	200-230	213T	Y488	213TTDW7202		\$1,131	S3	86.5	21.6-19.8/7.6-7.8	110	17.30	
	1800/900	460	213T	Y489	213TTDW7201	✓	\$1,131	S3	87.5	9.6/3.6	118	17.30	
10/2.5	1800/900	200-230	215T	Y490	215TTDW17206		\$1,429	S3	86.5	29.0-26.4/10.0-10.0	87	18.55	F,13
	1800/900	460	215T	Y491	215TTDW7201		\$1,429	S3	86.5	12.5/4.5	106	17.30	
15/3.75	1800/900	460	256T	Y492	256TTDX7207		\$1,876	S3	87.5	18.4/6.1	197	22.32	
20/5	1800/900	460	284T	Y493	284TTDP7202		\$2,335	S3	87.5	25.0/8.0	320	23.49	

Blue shaded areas are Cast Iron Frames

Multi-Speed: Two-Speed, Two-Winding, Variable Torque

Additional Features: • Economical two-winding design

HP	RPM	VOLTS	FRAME	CAT. NO.	MODEL NO.	STOCK	LIST PRICE	MULT. SYMB.	NOM. EFF.	F.L. AMPS	WEIGHT	"C" DIM.	FOOT NOTES
1/2.5	1800/900	460	145T	Y465	145TTDR5701	✓	\$785	S3	79.5	1.5/0.75	42	12.99	5,13
1/4.4	1800/1200	200-230	145T	Y449	145TTDR5703	✓	\$785	S3	80.0	3.4-3.2/2.0-2.0	42	12.99	5,13
	1800/1200	460	145T	Y450	145TTDR5704		\$785	S3	78.5	1.5/1.0	39	12.49	5,13
1.5/3.7	1800/900	460	145T	Y466	145TTDR5702	✓	\$861	S3	78.5	2.2/1.1	47	13.49	5,13
1.5/6.7	1800/1200	200-230	145T	Y451	145TTDR5705	✓	\$861	S3	80.0	5.0-4.8/2.6-2.9	47	13.49	5,13
	1800/1200	460	145T	Y452	145TTDR5706	✓	\$861	S3	78.5	2.3/1.3	42	12.99	5,13
2/5	1800/900	460	182T	Y467A	182TTDW7411	✓	\$949	S3	82.0	2.8/2.15	68	13.19	13
2/8.8	1800/1200	200-230	182T	Y1453	182TTDW7413	✓	\$949	S3	76.4	6.6-6.5/3.8-4	60	12.69	13
2/9	1800/1200	460	182T	Y409A	182TTDW7211	✓	\$949	S3	76.4	3.3/2.0	60	12.69	13
3/7.5	1800/900	460	184T	Y468A	184TTDW7230	✓	\$988	S3	82.5	4/2.75	68	13.72	13
3/1.3	1800/1200	200-230	184T	Y454A	184TTDW7286	✓	\$988	S3	82.0	9.0-8.6/4.6-5	74	13.69	13
	1800/1200	460	184T	Y412A	184TTDW7215	✓	\$988	S3	82.0	4.3/2.5	74	13.69	13
5/1.25	1800/900	460	215T	Y469	215TTDW7205	✓	\$1,382	S3	86.5	6.8/3.1	118	17.30	
5/2.22	1800/1200	200-230	215T	Y455	215TTDW7204	✓	\$1,382	S3	85.5	14.5-13.0/7.3-7.0	116	17.30	
	1800/1200	460	215T	Y415	215TTDW7203	✓	\$1,382	S3	85.5	6.5/3.5	106	17.30	
7.5/1.9	1800/900	460	254T	Y470	254TTDX7201		\$1,715	S3	85.5	10.5/4.1	135	20.57	
7.5/3.3	1800/1200	200-230	254T	Y456	254TTDX7278	✓	\$1,715	S3	87.5	20.8-18.4/11.0-10.2	175	22.32	
	1800/1200	460	254T	Y418	254TTDX7208	✓	\$1,715	S3	84.0	10.0/5.6	154	20.57	
10/2.5	1800/900	460	256T	Y471	256TTDX7253		\$2,126	S3	86.5	12.9/5.6	145	22.32	
10/4.4	1800/1200	200-230	256T	Y457	256TTDX7263		\$2,126	S3	88.5	28.0-26.0/15.0-14.0	214	22.32	
	1800/1200	460	256T	Y458	256TTDX7264	✓	\$2,126	S3	87.5	12.0/6.5	214	22.32	
15/3.8	1800/900	460	284T	Y472	284TTDP7205		\$2,844	S3	88.5	18.0/6.5	300	23.49	
15/6.7	1800/1200	460	284T	Y459	284TTDP7221	✓	\$2,844	S3	87.5	18.5/9.5	325	23.49	
20/5	1800/900	460	286T	Y473	286TTDP7251		\$3,543	S3	88.5	25.0/8.5	321	24.99	
20/8.9	1800/1200	460	286T	Y460	286TTDP7217	✓	\$3,543	S3	88.5	25.0/12.0	326	24.99	

Blue shaded areas are Cast Iron Frames

Instant Reversing

Single Phase

Features:

- Thermal protection, as noted
- Electronic instant reverse switch
- Extended clamp screws for mounting belt guard or accessories
- Three pole, double throw reversing switch supplied by customer



Capacitor Start, Dripproof

HP	RPM	VOLTS	FRAME	OVER LOAD	CAT. NO.	MODEL NO.	STOCK	LIST PRICE	MULT. SYMB.	F.L. AMPS	WEIGHT	"C" DIM.	FOOT NOTES
1/4	1800	115	48	NONE	CG382	5KC35GNA488	✓	\$301	F1	5.2	14	9.57	20
1/3	1800	115	56	MANUAL	CG384	5KC35JNA489Y	✓	\$371	F1	6.3	16	9.89	20
	1800	115	56	NONE	CG383	5KC35JNA489	✓	\$366	F1	6.3	15	9.89	20
1/2	1800	115/230	56	MANUAL	C1459	5KC46GN0251Y	✓	\$416	F1	8.8/4.4	21	10.78	19
	1800	115/230	56	NONE	C1458	5KC46GN0251	✓	\$395	F1	8.8/4.4	21	10.78	19
3/4	1800	115/230	56	MANUAL	C1461	5KC46LN0252Y	✓	\$474	F1	13.2/6.6	25	10.78	19
	1800	115/230	56	NONE	C1460	5KC46LN0252	✓	\$459	F1	13.2/6.6	25	10.78	19
1	1800	115/230	56	NONE	C1469	5KC49PN0253	✓	\$553	F1	13.6/6.8	31	11.38	18



Capacitor Start, TEFC

HP	RPM	VOLTS	FRAME	OVER LOAD	CAT. NO.	MODEL NO.	STOCK	LIST PRICE	MULT. SYMB.	F.L. AMPS	WEIGHT	"C" DIM.	FOOT NOTES
3/4	1800	115/230	56	MANUAL	C1489	5KC46PN0359Y	✓	\$583	F1	11.0/5.5	31	11.83	17



PSC, Dripproof

HP	RPM	VOLTS	FRAME	OVER LOAD	CAT. NO.	MODEL NO.	STOCK	LIST PRICE	MULT. SYMB.	F.L. AMPS	WEIGHT	"C" DIM.	FOOT NOTES
1/3	1625/1325	115	56	MANUAL	P254	5KCP35KNB650U	✓	\$371	F1	3.8	18	9.94	17
1/2	1625/1325	115	56	MANUAL	PG252	5KCP36NNB670U	✓	\$395	F1	5.4	18	10.33	17
	1625/1325	115	56	MANUAL	P253	5KCP36NNB671U	✓	\$416	F1	5.4	18	10.30	12,17



PSC, TENV

HP	RPM	VOLTS	FRAME	OVER LOAD	CAT. NO.	MODEL NO.	STOCK	LIST PRICE	MULT. SYMB.	F.L. AMPS	WEIGHT	"C" DIM.	FOOT NOTES
1/2	1625	115	48	AUTO	P247	5KCP35NNA670T	✓	\$327	F1	5.8	18	9.42	17,94,96

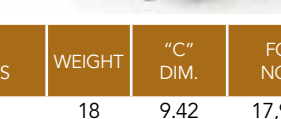

DEFINITE PURPOSE

Kiln Duty, XRI® Premium Efficiency Blue Chip® Severe Duty

Teao, Rigid Base, Three Phase

Applications:

Fans found in kilns and other high ambient environments where long life and high efficiency are desired. These TEAO motors must be mounted within the airstream for proper cooling. Suitable for use on variable frequency drives.



Features:

- Blue Chip® quality, 100% cast iron construction for rigidity and reduced vibration
- Internal and external epoxy paint
- CR²⁰⁰ Corona resistant magnet wire
- Class H insulation system
- Normally closed thermostats (one per phase, Class H)
- Heat stabilized ball bearings and high temperature grease
- Suitable for inverter use for 20:1 Variable Torque with 1.0 S.F. in 90°C ambient
- Suitable for 90°C ambient at 1.15 S.F. or 100°C ambient at 1.0 S.F.
- Extended grease tubes, regreasable in service
- 8 Foot Leads
- UL Recognized and CSA Certified

Suitable for use on VFD per guidelines on page 17.

HP	RPM	VOLTS	FRAME	CAT. NO.	MODEL NO.	STOCK	LIST PRICE	MULT. SYMB.	NOM. EFF.	F.L. AMPS	WEIGHT	"C" DIM.	FOOT NOTES
1	1200	460	145T	S501	145TTTN18577		\$1,309	E9	80.0	1.7	59	11.43	
2	1800	460	145T	S503	145TTTN18531		\$1,309	E9	85.5	2.8	68	11.43	
	1800	575	145T	S553	145TTTN18532		\$1,309	E9	85.5	2.3	69	11.43	
	1200	460	184T	S504	184TTTS18577		\$1,810	E9	87.5	3.0	115	13.71	
	1200	575	184T	S554	184TTTS18578		\$1,810	E9	87.5	2.4	115	13.71	
3	1800	460	182T	S506	182TTTS18532		\$1,769	E9	90.2	3.9	99	13.71	
	1200	460	213T	S507	213TTTS17077		\$1,922	E9	89.5	4.3	175	15.69	
	1200	575	213T	S557	213TTTS17078		\$1,922	E9	89.8	3.5	175	15.69	
5	1200	460	215T	S510	215TTTS17077	√	\$2,213	E9	87.5	6.9	185	17.19	
	1200	575	215T	S560	215TTTS17078		\$2,213	E9	88.5	5.5	200	17.19	
7 1/2	1200	460	254T	S513	254TTTNA17077	√	\$2,714	E9	90.2	9.8	660	20.60	
	900	575	256T	S564	256TTTNA18601		\$3,040	E9	88.5	8.6	310	22.35	
10	1200	460	256T	S516	256TTTNA18578	√	\$3,112	E9	91.0	12.8	140	22.35	
	1200	575	256T	S566	256TTTNA18577		\$3,112	E9	91.0	10.2	425	22.35	
	900	460	284T	S517	284TTTNA18601		\$3,226	E9	88.5	15.2	475	23.44	
	900	575	284T	S567	284TTTNA17101	√	\$3,226	E9	88.5	12.2	457	23.44,d	d
15	1800	460	254T	S518	254TTTNA18530		\$2,561	E9	92.4	18.2	276	20.60	
	1200	460	284T	S519	284TTTNA16577		\$3,727	E9	91.7	20.5	425	23.44	
	1200	575	284T	S569	284TTTNA18577		\$3,727	E9	91.7	16.4	475	23.44	
20	1200	460	286T	S522	286TTTNA18577		\$4,082	E9	91.7	27.0	520	24.94	
	900	460	324T	S523	324TTTS18601		\$4,988	E9	90.2	29.5	536	26.00	
25	1200	460	324T	S525	324TTTS18577		\$5,128	E9	92.4	33.0	675	26.00	
30	1200	460	326T	S528	326TTTS18577		\$5,430	E9	93.0	38.0	725	27.50	

Blue shaded areas are Cast Iron Frames

DEFINITE PURPOSE

Oil Well Pump, Three Phase

Dripproof, Rigid Base

Applications:

For use on walking beam pumps found in oil field service.

Features:

- NEMA design D for extra high starting and breakdown torques
- Normally closed thermostats (one per phase, Class F)
- Fully guarded with screens on all external openings
- Copper bar rotor on 500 frame
- Low starting current with 5-8% slip
- Class F insulation
- F2 conduit box location
- Ball bearings (except as noted)
- Shaft slinger
- Special "oil well" duty
- 1.15 Service Factor



DEFINITE PURPOSE

HP	RPM	VOLTS	FRAME	CAT. NO.	MODEL NO.	STOCK	LIST PRICE	MULT. SYMB.	NOM. EFF.	F.L. AMPS	WEIGHT	"C" DIM.	FOOT NOTES
3	1200	230/460/796	215T	Y201	215TTDW7376		\$1,295	S7	82.5	10.6/5.3/3.1	104	17.30	
5	1200	230/460/796	215T	Y202	215TTDW7377		\$1,496	S7	84.0	16.6/8.3/4.8	118	17.30	
7 1/2	1200	230/460/796	254T	Y203	254TTDX7377		\$1,925	S7	85.5	22.0/11.0/6.4	220	21.29	
10	1200	230/460/796	256T	Y204	256TTDX7391	✓	\$2,375	S7	86.5	29.0/14.5/8.4	462	23.04	
15	1200	230/460/796	284T	Y215	284TTDP7692	✓	\$2,872	S7	87.5	41.0/20.5/11.9	330	23.44	
20	1200	230/460/796	286T	Y216	286TTDP7689	✓	\$3,495	S7	87.5	53.0/26.5/15.3	368	24.94	
25	1200	460/796	324T	Y217	324TTDP7687	✓	\$4,290	S7	88.5	34.0/19.7	460	26.00	
30	1200	460/796	326T	Y218	326TTDP7697	✓	\$5,128	S7	88.5	40.0/23.1	498	27.50	
40	1200	460/796	365T	Y209	365TTDS7383		\$6,733	S7	87.5	48.0/27.7	713	29.93	
50	1200	460/796	404T	Y210	404TTDS7387		\$8,135	S7	87.5	60.0/34.5	951	32.81	
60	1200	460/796	405T	Y211	405TTDS7697		\$9,595	S7	87.5	71.0/41.0	1018	34.31	
75	1200	460/796	444T	Y212	444TTDS8699	✓	\$10,772	S7	90.2	91.5/53.0	1239	38.06	
100	1200	460/796	445T	Y213	445TTDS9477		\$14,363	S7	88.5	124/71.5	1327	40.06	
125	1200	460/796	505U	Y219	505UTDS1584		\$21,042	S7	90.2	145/84.0	1995	45.19	RB
150	1200	460/796	505U	Y220	505UTDS1590		\$22,486	S7	91.0	175/101	2285	45.19	RB

Blue shaded areas are Cast Iron Frames

Pressure Washer, Single Phase Dripproof

Features:

- Ball bearings, shaft end mechanically locked on C-face models
- Heavy gauge steel constructions
- Capacitor start/capacitor run design for higher efficiency, (except as noted)
- Continuous duty, 1.15 Service Factor (except as noted)
- Thermal protection on some models
- UL Recognized and CSA Certified



Rigid Base

HP	RPM	VOLTS	FRAME	OVER LOAD	CAT. NO.	MODEL NO.	STOCK	LIST PRICE	MULT. SYMB.	F.L. AMPS	WEIGHT	"C" DIM.	FOOT NOTES
3/4	3600	115	56	MANUAL	9032	5KC49MN2049Y	✓	\$250	F1	12.5	27	11.14	2,17
	1800	115	56	AUTO	9030	5KC49NN0222X		\$348	F1	10.5	16	11.14	2,17
	1800	115/208-230	56	MANUAL	K016	56B17D56	✓	\$348	F1	11.0/5.5-5.5	25	11.47	
1	3600	115/208-230	56	MANUAL	D010	56B34D2029	✓	\$287	F1	10.6/5.5-5.3	23	11.72	
	1800	115/230	56	MANUAL	C1480	5KC49PN0161U	✓	\$379	F1	13.6/6.8	31	11.38	2
1 1/2	3600	115/208-230	56	MANUAL	G987	56B34D2021		\$390	F1	14.8/8.0-7.4	26	11.72	
	1800	115/208-230	56H	MANUAL	G958	56B17D5323	✓	\$461	F1	13.2/7.2-6.6	37	11.94	5,14
2	3600	115/208-230	56H	MANUAL	G976	56B34D5304		\$483	F1	17.6/9.7-8.8	34	11.44	5,14
	1800	115/208-230	145T	MANUAL	I127	145TBDR5337	✓	\$534	S1	18.8/10.2-9.4	48	13.49	14
	1800	115/208-230	56H	MANUAL	G979	56B17D5319		\$608	F1	18.8/10.2-9.4	47	13.44	5,14
3	3600	208-230	56H	MANUAL	G996	56B34D5334		\$619	F1	14.2-12.5	44	12.44	5,14
	1800	208-230	184T	NONE	I128A	184TBDR7631	✓	\$624	S1	13.8-12.8	71	13.69	13
	1800	208-230	184T	MANUAL	I130A	184TBDR7630	✓	\$676	S1	13.8-12.8	70	13.69	13
5	1800	208-230	184T	MANUAL	I119	184TBDR7375		\$891	S1	25.0-24.1	83	16.22	13
	1800	208-230	184T	NONE	I131A	184TBDR7632	✓	\$900	S1	22.0-20.0	89	15.19	13

DEFINITE PURPOSE



C-Face Footed (Rigid Base)

HP	RPM	VOLTS	FRAME	OVER LOAD	CAT. NO.	MODEL NO.	STOCK	LIST PRICE	MULT. SYMB.	F.L. AMPS	WEIGHT	"C" DIM.	FOOT NOTES
1 1/2	3600	115/208-230	56C	MANUAL	K212	56B34D2018		\$409	F1	14.8/8.0-7.4	26	11.72	
	1800	115/208-230	56HC	MANUAL	G290	56B17D5328		\$478	F1	13.2/7.2-6.6	39	11.94	5
2	3600	115/208-230	56HC	MANUAL	G294	56B34D5307		\$499	F1	16.8/9.4-8.4	34	11.44	5
	1800	115/208-230	56HC	MANUAL	K232	56B17D5322	✓	\$596	F1	18.8/10.2-9.4	49	13.43	5
3	3600	208-230	56HC	MANUAL	K219	56B34D5336		\$635	F1	14.2-12.5	42	12.44	5
	1800	208-230	184TC	MANUAL	I305	184TBDR7628		\$741	S1	15.4-13.7	83	15.96	
5	1800	208-230	184TC	MANUAL	I308	184TBDR7634		\$1,020	S1	25.0-24.1	97	16.96	

Pressure Washer, Single Phase

Totally Enclosed Fan Cooled

Features:

- Ball bearings, shaft end mechanically locked on C-face models
- Heavy gauge steel constructions
- Capacitor start/capacitor run design for higher efficiency, (except as noted)
- Continuous duty, 1.15 Service Factor
- Manual reset thermal protector
- UL Recognized and CSA Certified



Rigid Base

HP	RPM	VOLTS	FRAME	CAT. NO.	MODEL NO.	STOCK	LIST PRICE	MULT. SYMB.	F.L. AMPS	WEIGHT	"C" DIM.	FOOT NOTES
3/4	3600	115/208-230	56	G379	56C34F5309	✓	\$278	F1	10.6/5.3-5.3	26	12.32	2,14
	1800	115/208-230	56	G356	56C17F5308	✓	\$384	F1	11.0/5.4-5.5	29	12.32	2,14
1	3600	115/208-230	56	G390	56C34F5311	✓	\$315	F1	12.4/6.7-6.2	31	12.32	2,14
	1800	115/208-230	56	G373	56C17F5311	✓	\$402	F1	13.4/6.8-6.7	30	12.82	2,14
1 1/2	3600	115/208-230	56	K332	56B34F5303		\$427	F1	12.1/6.9-6.1	37	13.32	14
	1800	115/208-230	56H	G378	56B17F5302	✓	\$461	F1	15.2/8.2-7.6	40	13.82	5,14
2	1800	115/230	145T	I702	145TBFR5336		\$591	S1	18.8/9.4	52	14.87	14

DEFINITE PURPOSE



C-Face Footed (Rigid Base)

HP	RPM	VOLTS	FRAME	CAT. NO.	MODEL NO.	STOCK	LIST PRICE	MULT. SYMB.	F.L. AMPS	WEIGHT	"C" DIM.	FOOT NOTES
1/2	1800	115/208-230	56C	G380	56C17F5957		\$355	F1	8.8/4.2-4.4	27	11.82	2
3/4	1800	115/208-230	56C	G381	56C17F5955	✓	\$425	F1	11/5.4-5.5	22	12.32	2
1	1800	115/208-230	56C	G382	56C17F5956	✓	\$444	F1	13.4/6.8-6.7	31	12.82	2
1 1/2	3600	115/208-230	56C	K612	56B34F5306	✓	\$443	F1	12.1/6.9-6.0	37	13.32	
	1800	115/208-230	56HC	G396	56B17F5310	✓	\$506	F1	13.6/7.5-6.8	43	13.82	5
2	3600	115/230	56HC	K615	56B34F5312	✓	\$526	F1	17.5/8.7	37	13.32	5
	1800	115/230	145TC	I311	145TBFR5333		\$716	S1	18.8/9.4	52	14.87	
	1800	115/230	56HC	K319	56B17F5319	✓	\$601	F1	18.8/9.4	50	14.82	5
3	3600	230	56HC	K618	56B34F5318	✓	\$663	F1	11.8	51	14.82	5
	1800	230	184TC	I314A	184TBFW7041	✓	\$896	S1	12.8	86	14.96	13
5	1800	230	184TC	I315A	184TBFW7034	✓	\$1,069	S1	19.5	101	17.47	13,17

Woodworking/Power Tool, Single Phase

Totally Enclosed, Rigid Base

Applications:

Replacement motors for table saws, planers, lathes, and other equipment found in the woodworking and metalworking trades. These totally enclosed, fan cooled motors are well suited for use in dusty and dirty environments or where wood or metal shavings are present.

Features:

- Capacitor start design for high starting torque with low amps
- Double sealed ball bearings
- Heavy gauge steel frame and base
- 1.15 Service Factor
- Manual reset thermal protector
- Dependable, dust-proof centrifugal starting switch
- On/off toggle switch and 8 foot cord with 115 volt plug included on 1/2 to 1-1/2 HP models
- UL Recognized and CSA Certified



HP	RPM	VOLTS	FRAME	CAT. NO.	MODEL NO.	STOCK	LIST PRICE	MULT. SYMB.	F.L. AMPS	WEIGHT	"C" DIM.	FOOT NOTES
1/2	1800	115/208-230	56	T010	56C17F5351	✓	\$367	F1	8.8/4.2-4.4	29	11.82	2
3/4	3600	115/208-230	56	T013	56C34F5340	✓	\$332	F1	10.6/5.3-5.3	27	12.32	2
	1800	115/208-230	56	T014	56C17F5350	✓	\$429	F1	11.0/5.4-5.5	30	12.32	2
1	3600	115/208-230	56	T015	56C34F5339	✓	\$369	F1	12.4/6.7-6.2	30	12.32	2
	1800	115/208-230	56	T016	56C17F5349	✓	\$454	F1	13.4/6.8-6.7	31	12.82	2,d
1 1/2	3600	115/208-230	56	T017	56B34F5332	✓	\$453	F1	14.2/7.7-7.1	33	12.82	1
	1800	115/208-230	56	T018	56B17F5328	✓	\$551	F1	13.6/7.5-6.8	44	13.73	1
2	3600	115/230	56H	T019	56B34F5333	✓	\$493	F1	17.5/8.7	36	13.41	1,5
	1800	115/230	56H	T030	56B17F5329		\$608	F1	18.8/9.4	50	14.82	1,5
3	3600	208-230	145T	T031	145TBFR5309	✓	\$684	S1	13.1/11.8	51	14.87	1

DEFINITE PURPOSE

50 Hertz, Three Phase

Dripproof, Rigid Base

Features:

- Ball bearings
- 1.15 Service Factor
- Nameplated 190-200-208/380-400-416 (except as noted)
- 12 Lead delta capability
- UL Recognized and CSA Certified



Suitable for use on VFD per guidelines on page 17.

HP	RPM	VOLTS	FRAME	CAT. NO.	MODEL NO.	STOCK	LIST PRICE	MULT. SYMB.	NOM. EFF.	F.L. AMPS	WEIGHT	"C" DIM.	FOOT NOTES
2	1500	220/380	145T	KG319	5K49UN8052		\$458	E6	81.5	6.4/3.7	40	14.24	
	1500	190-208/380-416	145T	H952	145TTDR5647		\$458	E6	82.5	7.2-7.3/3.6-3.65	41	12.99	F,YD,5,14
3	1500	190-208/380-416	182T	H953	182TTDR8353	✓	\$510	E6	81.5	10.0-9.8/5.0-4.9	60	13.22	F,YD,25
5	1500	190-208/380-416	184T	H954	184TTDR9040	✓	\$648	E6	82.5	16.2-15.6/8.1-7.8	80	14.72	F,YD,25
7 1/2	1500	190-208/380-416	213T	H955	213TTDW7053		\$851	E6	85.5	22.6-19.0/9.5-11.3	106	17.30	YD
10	1500	190-208/380-416	215T	H956	215TTDW7053		\$1,013	E6	88.5	31.0-29.1/15.5-14.5	135	17.30	YD
15	1500	190-208/380-416	254T	H957	254TTDX8338	✓	\$1,341	E6	88.5	46.0-44.0/23.0-22.0	180	22.32	F,YD

MOD CENTRAL - Motor Modifications

Mod Central

Marathon Motors offers the capability to modify stock motors in a matter of days to meet our customer's special needs. Mod Central is centrally located in the motor industry's largest Distribution Center in Indianapolis, Indiana. This state-of-the-art facility stocks a vast array of motors and accessories along with a staff of skilled technicians who provide the highest quality of service. If you need motor modifications on 20 motors or less and want to avoid special engineering and manufacturing schedules, call Marathon Motors and take advantage of our **MOD CENTRAL** Motor Modification Program.

Lead-Time

All lead-times indicated are subject to availability of the stock motors and parts at the time of order placement. If a stock motor is shipped from a remote warehouse to Indianapolis for modification, the cost of the inbound freight will be added to the price of the modified motor and the delivery of the modified motor will be extended by the inbound transit time. **(Lead-times in working days are calculated from normal business hours excluding holidays and weekends and do not include the day the purchase order is received.)** Large quantities may require additional lead-time.

Mod Central Hours

The Modification Center is open from 7:00 a.m. to 5:00 p.m. CST Monday through Friday.

How to Order

First determine whether you need a kit to perform the modification, if you do not need a kit, then the modification list price includes all supplies to perform that modification. If a kit is needed, the modification list price is the labor to install the kit. The kit list price and the motor list price are not included. You must add the net price of the motor, and kit to the net price of the modification(s) to calculate the total price of the modified motor.

For example, to add a C-Face Kit and Thermostats to Catalog Motor U633, you would calculate the total price as follows:

	List Price	Mult Symbol
Kit 175191 (A653).....	\$165 list	S4
Modification MOD2L, add C-Face to 254T-256T Frame motor	\$195 list	S4
Modification MOD14E, add thermostats to 254T-256T Frame motor	\$278 list	S4
TOTAL	\$638 list	

Add the net price of U633 (\$1324 list price times (x) your motor multiplier) to the net adder for the kit and modifications (\$638 times (x) your Mod Center multiplier of S4) to find the total net price for the modified motor.

Freight Terms

Standard terms and conditions apply.

Exceptions

Some modifications do not apply to explosion proof motors.

Discount Multiplier

Discount symbol S4 applies to all list prices, except where noted.

Cancellation Policy

If a Mod Central order is cancelled after the motor is modified but before it ships, a cancellation charge of double the modification charge will be invoiced to the customer. Any Mod Central order cancelled before modifications are completed, is subject to a cancellation charge of 25% of the total modification charges for that item.

Once shipped, modified motors may not be returned for credit or restocking.

MOD CENTRAL - Motor Modifications

MODIFICATION DESCRIPTION	MODIFICATION NUMBER	PRODUCT	FRAME	LEAD-TIME DAYS*
Altitude/Ambient				
• AC Motor Altitude or Ambient Re-Rating	MOD7	All Non-EXP	48-449T	2
• AC Motor Altitude or Ambient Re-Rating	MOD7	Explosion Proof	143T-449T	2
Assembly (see Mounting)				
Bearings				
• Convert Ball to Roller (Drive End)	MOD18	TEFC	364T-449T	3
• Convert Roller to Ball (Drive End)	MOD18	TEFC	444T-449T	2
• Sealed Bearing	MOD18	All Non-EXP	143T-449T	Call
• Insulated Bearing	MOD18	Non Div 1 or 2	143T-449T	Call
Blowers				
• Axial Blower	MOD19	TEFC	213T-449T	3
Brackets				
• C-Face Non-Explosion Proof	MOD2	All Non-EXP	56-449T	2
• C-Face Explosion Proof	MOD2	Explosion Proof	56,254T-449T	Call
• C-Face IEEE 841	MOD2	All Non-EXP	143T-449T	2
• D-Flange	MOD17	All Non-EXP	254T-365T	Call
• B14 FT Flange (IEC C-Face)	MOD55	IEC	63-160	2
• B5 FF Flange (IEC D-Flange)	MOD55	IEC	63-315	2
Brake Motors				
• Brake Motors-Single Phase	MOD3	TEFC	56C	3
• Brake Motors-Three Phase	MOD3	TEFC	56C-145TC	3
• Brake Motors-Inverter Duty	MOD3	TENV	56C-326TC	3
• Electrical Modifications-Brake Coil	MOD3	Brake Motors	56-256TC	10
• Vertical Brake Mounting (Shaft Up or Shaft Down)	MOD3	All Brakes	56-256TC	3
Conduit Box				
• Rotate Conduit Box Lead Opening	MOD56	All Non-EXP	143T-449T	2
• Convert to Cast Iron	MOD56	All Non-EXP	143T-326T	2
• Auxiliary Box (Condulet)	MOD56	All Non-EXP	182T-5013L	Call
Connections				
• SO Cord, Plug, and Switch-Single Phase	MOD0	TEFC	48-215T	Call
Drains				
• Condensation Drain Holes	MOD21	All Non-EXP	143T-449T	2
• Brass Drain & Breather	MOD21	All Non-EXP	143T-449T	2
• Stainless Steel Drain & Breather	MOD21	All Non-EXP	143T-449T	2
Drip Covers				
• Canopy Cover	MOD4	ODP, TEFC	48-256T	2
Encoders				
• Avtron AV56 - Black Max® / Blue Max®	MOD22	TENV, TEBC	56-449T	2
• Avtron HS25A & HS35A	MOD22	TENV, TEBC	56-449T	2
• Avtron M56/M85 - Black Max®/ Blue Max® brake motors	MOD24	TENV	143T-256T	2
• Northstar SL56 - Black Max®/Blue Max®	MOD22	TENV, TEBC	56-449T	2
• Northstar SL56/SL85 - Black Max®/ Blue Max® brake motors	MOD24	TENV	143T-256T	2
• Dynapar HS20, HS35R, & HSD38 - Black Max® / Blue Max®	MOD22	TENV, TEFC, TEBC	56-449T	2
• BEI HS35 - Black Max®/Blue Max®	MOD31	TENV, TEFC, TEBC	56-449T	2
• Stub Shaft (XRI®-SD & XRI®-841,TEFC only)	MOD42	TEFC	182-449T	2
Fan				
• Oversized fan (see Inverter Duty modification)	MOD43	TEFC	213T-449T	2
• Fan Removal	MOD44	All Non-EXP	56-449T	2
• Vane Axial	MOD43	All Non-Exp	143T-449T	4
Frequency				
• Frequency Re-Rate 60 Hz to 50 Hz	MOD7	All	56-449T	1
Grease/Fittings				
• Grease Relief Fittings	MOD15	All Non-EXP	143T-449T	2
• Zerk Fittings (Cast Iron Motors)	MOD15	All Non-EXP	182T-449T	2
• Low Temperature Grease	MOD0	All	48-449T	2
• High Temperature Grease	MOD0	All	48-449T	2

*Lead-time days does not include the day order is received

MOD CENTRAL - Motor Modifications

MODIFICATION DESCRIPTION	MODIFICATION NUMBER	PRODUCT	FRAME	LEAD-TIME DAYS*
Grounding				
• Conduit Box Grounding Lug	MOD20	All	48-215T	2
• On-Frame Grounding (Cast Iron Motors)	MOD20	All	143T-449T	2
• Shaft Grounding Ring	MOD20	Call	48-449T	2
Inverter Duty Motors				
• Variable Torque with Thermostats (R140)	MOD25	All	143T-449T	2
• Constant Torque with Thermostats (R142)	MOD26	All	143T-449T	2
• Constant Torque (R164)	MOD43	All	143T-449T	2
Leads				
• Reconnect Leads	MOD9	All	48-449T	2
• Terminal Lugs	MOD0	All	48-326T	2
• Remark Leads	MOD33	All	48-449T	2
• Longer Leads - Up to 24"	MOD0	All Non-EXP	48-449T	2
Mounting/Assembly (Example: F1 to F2)				
• Convert to Floor, Top, Ceiling, or Wall	MOD1	All Non-EXP	143T-449T	2
• Convert to Floor, Top, Ceiling, or Wall	MOD39	Explosion Proof	143T-449T	2
• Adjustable Bases	MOD39	All	143T-449T	2
Nameplates / Markings				
• Additional Data on Nameplate	MOD7	All	48-449T	1
• CE Marking	MOD7	All	48-449T	2
• Private Label	MOD7	All	48-449T	1
• Rotation Arrow	MOD7	Single Phase	48-215T	1
• Separate Nameplate for Customer Data	MOD7	All	48-449T	2
• Stainless Steel Nameplate	MOD7	All	48-449T	1
Packaging				
• Heat Treated Pallet	MOD29	All	48-449T	3
Paint				
• Repaint to a Marathon stock color	MOD8	All	48-449T	2-3
Screens				
• Rodent Screens	MOD0	ODP	364T-449T	Call
Service Factor				
• AC Motor Service Factor Re-Rating	MOD7	All Non-EXP	48-449T	1
Severe Duty Construction				
• Cast Iron Fan Cover and Conduit Box	MOD16	All Non-EXP	143T-449T	2
Shaft Grounding Ring (see Grounding)				
Shaft Modifications				
• Drill & Tap Hole	MOD42	All	56-449T	3
• TS Shaft	MOD42	All	284T-449T	2
• Mill Flat on Shaft	MOD0	All	56-184T	2
• Steps on Shaft	MOD0	All	143T-449T	Call
Space Heaters				
• Non Explosion Proof	MOD12	All Non-EXP	48-449T	2
• Explosion Proof	MOD41	Explosion Proof	56-449T	2
• IEC Frames	MOD12	IEC	100-250	2
Terminal Blocks				
• Terminal Block	MOD0	All Non-EXP	180-449T	Call
Thermal Protection				
• Thermostats - Windings	MOD14	All	56-449T	2
• Thermistors - Windings	MOD14	All	143T-449T	2
• Thermistors (including Control Module)	MOD14	All Non-EXP	143T-449T	2
• Thermocouples - Winding or Bearing	MOD0	All Non-EXP	145T-449T	2
Weatherproofing / Special Service				
• Tropical Anti-Fungus Treatment	MOD5	All	48-449T	2
• Division 2 Motors (CSA Certified)	MOD49	Blue Chip®/XRI®	143T-449T	Call

*Lead-time days does not include the day order is received

MOD CENTRAL - Stock Motors Only

Mult. Symbol is S4 (except as noted)

Contact Marathon Motors for all modification services on Explosion Proof and Blower (TEBC) motors.

NEMA MOTORS

DESCRIPTION	KIT REQ'D	LIST PRICE												
		MOD #	48	56	143-145	182-184	213-215	254-256	284-286	324-326	364-365	404-405	444-445	447-449
Altitude / Ambient		7	\$114	\$114	\$114	\$114	\$114	\$114	\$114	\$114	\$114	\$114	\$114	\$114
Bearings														
Convert Ball to Roller (Drive End)	Yes	18	-----	-----	-----	-----	-----	-----	-----	-----	\$200	\$200	\$250	\$250
Convert Roller to Ball (Drive End)	Yes	18	-----	-----	-----	-----	-----	-----	-----	-----	-----	-----	\$250	\$250
Sealed Bearings		18	\$197	\$197	\$197	\$263	\$263	\$362	\$461	\$625	\$1,084	\$1,084	\$1,478	\$1,478
Insulated Bearings		18	-----	-----	\$461	\$526	\$526	\$1,530	\$1,645	\$1,645	\$1,737	\$1,776	\$1,882	\$2,061
Blowers														
Axial Blower	Yes	19	-----	-----	-----	-----	\$308	\$270	\$270	\$270	\$520	\$520	\$520	\$520
Brackets*														
C-Face (Non-Explosion Proof)	Yes	2	-----	\$143	\$143	\$168	\$168	\$195	\$290	\$329	\$329	\$329	\$329	\$329
C-Face (Explosion Proof)	Yes	2	-----	\$238	-----	-----	-----	\$325	\$483	\$648	\$648	\$648	\$948	\$948
C-Face (IEEE 841)	Yes	2	-----	-----	\$238	\$280	\$280	\$325	\$425	\$489	\$489	\$489	\$489	\$489
D-Flange	Yes	17	-----	-----	-----	-----	-----	\$168	\$240	\$408	\$408	-----	-----	-----
Brakes														
3 lb-ft for a TEFC motor	Yes	3	-----	\$165	\$165	-----	-----	-----	-----	-----	-----	-----	-----	-----
6 lb-ft for a TEFC motor	Yes	3	-----	\$165	\$165	-----	-----	-----	-----	-----	-----	-----	-----	-----
10 lb-ft for a TEFC motor	Yes	3	-----	\$165	\$165	-----	-----	-----	-----	-----	-----	-----	-----	-----
6 lb-ft for a Black Max (TENV) motor	Yes	3	-----	\$165	\$165	\$165	\$165	-----	-----	-----	-----	-----	-----	-----
10 lb-ft for a Black Max (TENV) motor	Yes	3	-----	\$165	\$165	\$165	\$165	\$165	\$165	-----	-----	-----	-----	-----
Brake Coil (56000 Series)		3	-----	\$410	\$410	\$410	-----	-----	-----	-----	-----	-----	-----	-----
Brake Coil (87000 Series)		3	-----	-----	-----	\$510	\$510	\$510	-----	-----	-----	-----	-----	-----
Vertical Mounting - Up or Down	Yes	3	-----	-----	-----	-----	\$73	\$73	-----	-----	-----	-----	-----	-----
Vertical Mounting - Shaft Down	Yes	3	-----	-----	-----	-----	\$73	\$73	-----	-----	-----	-----	-----	-----
Conduit Box														
Rotate Conduit Box Lead Opening		56	-----	-----	\$145	\$145	\$145	\$145	\$145	\$145	\$145	\$145	\$145	\$145
Convert to Cast Iron	Yes	56	-----	-----	\$158	\$158	\$158	\$174	\$188	\$217	-----	-----	-----	-----
Auxiliary Box (Condulet)		56	-----	-----	-----	\$217	\$217	\$289	\$289	\$289	\$434	\$434	\$434	\$434
Connections:														
SO Cord, Plug, and Switch Single Phase		0	\$287	\$287	\$287	\$287	\$287	-----	-----	-----	-----	-----	-----	-----
Drains														
Condensation Drain Holes		21	-----	-----	\$171	\$171	\$171	\$191	\$191	\$191	\$191	\$191	\$191	\$191
Brass Drain & Breather		21	-----	-----	\$182	\$182	\$182	\$326	\$326	\$326	\$326	\$326	\$326	\$326
Stainless Steel Drain & Breather		21	-----	-----	\$263	\$263	\$263	\$471	\$471	\$471	\$471	\$471	\$471	\$471
Drip Cover														
Canopy Cover (ODP & TEFC Motors)	Yes	4	\$121	\$121	\$121	\$121	\$160	\$256	-----	-----	-----	-----	-----	-----
Encoders (NOTE: Multiplier Symbol E3)														
Avtron AV56	Yes	22	-----	\$0	\$0	\$0	\$0	\$0	-----	-----	-----	-----	-----	-----
Avtron HS25A	Yes	22	-----	\$0	\$0	\$0	\$0	\$0	-----	-----	-----	-----	-----	-----
Avtron HS35A	Yes	22	-----	\$0	\$0	\$0	\$0	\$0	\$0	\$0	\$0	\$0	\$0	\$0
Avtron HS35M	Yes	22	-----	\$0	\$0	\$0	\$0	\$0	\$0	\$0	\$0	\$0	\$0	\$0
Avtron M3	Yes	22	-----	\$0	\$0	\$0	\$0	\$0	\$0	\$0	\$0	\$0	\$0	\$0
BEI HS35	Yes	22	-----	\$0	\$0	\$0	\$0	\$0	\$0	\$0	\$0	\$0	\$0	\$0
Dynapar HS20	Yes	22	-----	\$0	\$0	\$0	\$0	\$0	-----	-----	-----	-----	-----	-----
Dynapar HS35R	Yes	22	-----	\$0	\$0	\$0	\$0	\$0	\$0	\$0	\$0	\$0	\$0	\$0
EPC 260	Yes	22	-----	\$0	\$0	\$0	\$0	\$0	\$0	-----	-----	-----	-----	-----
NorthStar HSD35	Yes	22	-----	\$0	\$0	\$0	\$0	\$0	\$0	\$0	\$0	\$0	\$0	\$0
NorthStar SL56	Yes	22	-----	\$0	\$0	\$0	\$0	\$0	-----	-----	-----	-----	-----	-----
Blue Max TEBC Encoders:														
Avtron HS35A	Yes	24	-----	-----	-----	-----	-----	-----	\$0	\$0	\$0	\$0	\$0	\$0
Avtron AV56	Yes	24	-----	-----	-----	-----	-----	-----	\$0	\$0	\$0	\$0	\$0	\$0
Dynapar HSD38	Yes	24	-----	-----	-----	-----	-----	-----	\$0	\$0	\$0	\$0	\$0	\$0
NorthStar SL56	Yes	24	-----	-----	-----	-----	-----	-----	\$0	\$0	\$0	\$0	\$0	\$0
Turck A02H	Yes	24	-----	-----	-----	-----	-----	-----	\$0	\$0	\$0	\$0	\$0	\$0
Blue Max Brakemotor Encoders:														
Avtron AV56	Yes	24	-----	-----	\$0	\$0	-----	-----	-----	-----	-----	-----	-----	-----
Avtron M85	Yes	24	-----	-----	-----	\$0	\$0	\$0	-----	-----	-----	-----	-----	-----
NorthStar SL56	Yes	24	-----	-----	\$0	\$0	-----	-----	-----	-----	-----	-----	-----	-----
NorthStar SL85	Yes	24	-----	-----	-----	\$0	\$0	\$0	-----	-----	-----	-----	-----	-----
Stub Shaft: (XRI®-SD & XRI®-841, TEFC only)	Yes	42	-----	-----	-----	\$182	\$182	\$182	\$182	\$182	\$182	\$182	\$182	\$182
Fan														
Oversized fan (Inverter Duty)		43	-----	-----	-----	-----	\$230	\$263	\$263	\$263	\$296	\$329	\$329	\$329
Fan Removal		44	-----	\$145	\$145	\$182	\$182	\$217	\$217	\$217	\$254	\$254	\$254	\$254
Vane Axial		43	-----	-----	\$315	\$623	\$623	\$934	\$934	\$934	\$1,231	\$1,231	\$1,231	\$1,231
Frequency														
Re-Rate 60Hz to 50Hz		7	\$114	\$114	\$114	\$114	\$114	\$114	\$114	\$114	\$114	\$114	\$114	\$114
Grease/Fittings														
Grease Relief Fittings		15	-----	-----	\$174	\$174	\$174	\$174	\$174	\$174	\$174	\$174	\$174	\$174
Zerk Fittings (Cast Iron Motors)		15	-----	-----	-----	\$276	\$276	\$276	\$276	\$276	\$276	\$276	\$276	\$276
Low Temperature Grease		0	\$461	\$461	\$461	\$816	\$816	\$816	\$816	\$816	\$1,092	\$1,461	\$1,461	\$1,461
High Temperature Grease		0	\$461	\$461	\$461	\$816	\$816	\$816	\$816	\$816	\$1,092	\$1,461	\$1,461	\$1,461

*Addition of C-Face Kits may result in non-NEMA "BA", dimension. For the resulting "BA" dimension consult chart found in modification section

MOD CENTRAL - Stock Motors Only

Mult. Symbol is S4 (except as noted)

Contact Marathon Motors for all modification services on Explosion Proof and Blower (TEBC) motors.

DESCRIPTION	KIT REQ'D	LIST PRICE												
		MOD #	48	56	143-145	182-184	213-215	254-256	284-286	324-326	364-365	404-405	444-445	447- 449
Grounding:														
Conduit Box Grounding Lug		20	\$105	\$105	\$105	\$118	\$118	----	----	----	----	----	----	----
On-Frame Grounding (Cast Iron Motors)		20	----	----	\$145	\$158	\$158	\$239	\$239	\$239	\$334	\$334	\$334	\$334
Shaft Grounding Ring	Yes	20	\$177	\$177	\$177	\$204	\$204	\$292	\$292	\$403	\$531	\$553	\$776	\$776
Inverter Duty Motors:														
Variable Torque (R140)		25	----	----	\$278	\$278	\$278	\$278	\$278	\$278	\$278	\$278	\$278	\$278
Constant Torque (fan chg, t-stats, re-nameplate)		26	----	----	\$278	\$278	\$278	\$441	\$441	\$441	\$441	\$542	\$542	\$542
Constant Torque (R164, fan chg, re-nameplate)		43	----	----	\$230	\$230	\$230	\$263	\$263	\$263	\$296	\$329	\$329	\$329
Leads:														
Reconnect Leads (Non-Explosion Proof)		9	\$168	\$168	\$168	\$249	\$249	\$439	\$439	\$439	\$575	\$575	\$575	\$575
Reconnect Leads (Explosion Proof)		40	\$271	\$271	\$271	\$417	\$417	\$562	\$562	\$562	\$709	\$709	\$709	\$709
Remark Leads		33	\$176	\$176	\$176	\$176	\$176	\$176	\$176	\$176	\$176	\$176	\$176	\$176
Longer Leads - Up to 24"		0	\$138	\$138	\$138	\$207	\$207	\$362	\$362	\$362	\$507	\$507	\$507	\$507
Mounting/ Assembly: (Ex. F1 to F2):														
Non-Explosion Proof		1	----	----	\$209	\$209	\$209	\$278	\$278	\$278	\$347	\$347	\$347	\$347
Explosion Proof		39	----	----	\$487	\$487	\$487	\$555	\$555	\$555	\$626	\$626	\$626	\$626
Adjustable Motor Bases	Yes	39	----	----	\$143	\$143	\$143	\$143	\$143	\$143	\$143	\$143	\$143	\$143
Transition Motor Bases	Yes	39	----	----	\$143	\$143	\$143	\$143	\$143	\$143	\$143	\$143	\$143	\$143
Nameplates / Markings:														
Additional Data on Nameplate		7	\$114	\$114	\$114	\$114	\$114	\$114	\$114	\$114	\$114	\$114	\$114	\$114
CE Marking		7	\$114	\$114	\$114	\$114	\$114	\$114	\$114	\$114	\$114	\$114	\$114	\$114
Private Label		7	\$114	\$114	\$114	\$114	\$114	\$114	\$114	\$114	\$114	\$114	\$114	\$114
Rotation Arrow		7	\$114	\$114	\$114	\$114	\$114	----	----	----	----	----	----	----
Stainless Steel Nameplate		7	\$114	\$114	\$114	\$114	\$114	\$114	\$114	\$114	\$114	\$114	\$114	\$114
Separate Nameplate for Customer Data		7	\$114	\$114	\$114	\$114	\$114	\$114	\$114	\$114	\$114	\$114	\$114	\$114
Packaging:														
Heat Treated Pallets		29	\$50	\$50	\$50	\$50	\$125	\$125	\$250	\$250	\$250	\$250	\$250	\$250
Paint:														
Repaint to a Marathon Stock Color		8	\$211	\$211	\$211	\$211	\$211	\$263	\$263	\$263	\$461	\$461	\$461	\$592
Screens:														
Rodent Screens		0	----	----	----	----	----	----	----	----	\$661	\$661	\$661	\$661
Service Factor:														
AC Motor Service Factor Re-Rating		7	\$114	\$114	\$114	\$114	\$114	\$114	\$114	\$114	\$114	\$114	\$114	\$114
Severe Duty Construction:														
Cast Iron Fan Cover and Conduit Box	Yes	16	----	----	\$147	\$181	\$200	\$225	\$225	\$225	\$273	\$273	\$273	----
Shaft Modifications:														
Drill & Tap Hole		42	----	\$174	\$174	\$197	\$257	\$316	\$316	\$458	\$507	\$572	\$724	\$724
TS Shaft		42	----	----	----	----	----	----	\$1,579	\$1,579	\$1,711	\$1,911	\$1,911	\$1,911
Mill Flat on Shaft		0	----	\$174	\$174	\$197	----	----	----	----	----	----	----	----
Steps on Shaft		0	----	----	\$217	\$289	\$289	\$362	\$434	\$507	\$579	\$651	\$724	\$796
Space Heaters:														
Non Explosion Proof		12	\$278	\$278	\$278	\$400	\$400	\$471	\$471	\$471	\$661	\$661	\$661	\$661
Explosion Proof		41	----	\$417	\$417	\$525	\$525	\$661	\$661	\$661	\$800	\$800	\$800	\$800
Terminal Blocks:														
Terminal Block	Yes	0	----	----	----	\$294	\$294	\$351	\$351	\$351	\$358	\$358	\$437	\$437
Thermal Protection:														
Thermostats (Non Explosion Proof)		14	----	\$278	\$278	\$278	\$278	\$278	\$278	\$278	\$278	\$278	\$278	\$278
Thermostats (Explosion Proof Motors)		14	----	\$556	\$556	\$556	\$556	\$556	\$556	\$556	\$556	\$556	\$556	\$556
Thermistors (Non Explosion Proof motors)		14	----	----	\$522	\$522	\$522	\$522	\$522	\$522	\$522	\$522	\$522	\$522
Thermistors (Explosion Proof motors)		14	----	----	\$1,053	\$1,053	\$1,053	\$1,053	\$1,053	\$1,053	\$1,053	\$1,053	\$1,053	\$1,053
Thermistors (including Control Module)		14	----	----	\$1,391	\$1,391	\$1,391	\$1,391	\$1,391	\$1,391	\$1,391	\$1,391	\$1,391	\$1,391
Thermocouples - Winding or Bearing (Non XP)		0	----	----	\$305	\$305	\$305	\$399	\$399	\$399	\$575	\$575	\$575	\$575
Weatherproofing / Special Service:														
Tropical Anti- Fungus Treatment		5	\$242	\$242	\$242	\$242	\$242	\$313	\$313	\$313	\$382	\$382	\$382	\$382
Division 2 Hazardous (CSA Certified)		49	----	----	\$114	\$339	\$339	\$441	\$441	\$441	\$224	\$224	\$224	\$224
Other Modifications:		0	CONSULT FACTORY											

MODIFICATIONS THROUGH MOD CENTRAL

IEC Motors

DESCRIPTION	Requires Kit	LIST PRICE															
		Mod#	63	71	80	90	100	112	132	160	180	200	225	250	280	315	
BRACKETS:																	
FF Flange (B5)	Yes	55	\$158	\$162	\$170	\$179	\$200	\$221	\$221	\$221	\$221	\$221	\$221	\$221	\$221	\$221	\$221
FT Flange (B14)	Yes	55	\$158	\$162	\$170	\$179	\$200	\$221	\$221	\$221	----	----	----	----	----	----	----
SPACE HEATERS:																	
		12	----	----	----	----	\$405	\$502	\$502	\$554	\$554	\$554	\$693	\$693	\$693	\$693	\$693
THERMOSTATS:																	
		14	----	----	----	----	\$278	\$278	\$278	\$278	\$278	\$278	\$278	\$278	\$278	\$278	\$278
HEAT TREATED PALLET:																	
		29	\$95	\$95	\$95	\$95	\$250	\$250	\$325	\$325	\$325	\$325	\$325	\$325	\$325	\$325	\$325
OTHER MODIFICATIONS:																	
		0	CONSULT FACTORY														

MOD CENTRAL - Motor Modifications

Altitude/Ambient - MOD7 (Mult. Symbol S4)

The rating of standard motors assumes operation at sea level. Listed motors are suitable for operation at altitudes up to 3,300 feet in a maximum ambient temperature of 40°C. The ambient temperature is the temperature of the cooling medium surrounding the motor. All standard motors are suitable for operation over the range of -15°C to 40°C ambient per NEMA MG-1.

AC Motor Altitude or Ambient Re-Rating Re-rating of a non-explosion proof motor can be done by evaluating the performance data and possibly changing the Service Factor. Contact Marathon Motors for motor capabilities prior to motor selection and modification.

Bearings - MOD18 (Mult. Symbol S4)

Most standard motors use anti-friction deep groove Conrad type ball bearing, sized for the loads to be expected in industrial applications. Roller bearings are used on the drive end to handle heavy or overhung (radial) shaft loads.

Ball to Roller Bearing

Roller bearings have the capability to handle higher radial loads than ball bearings, but must have minimum radial loads to operate correctly. Roller bearings must only be used on belted loads. They are not suitable for direct-coupled loads. (Marathon Motors recommends that belting data is reviewed by Engineering prior to converting any motor to roller bearing.) This option includes replacing only the standard drive end bearing with a roller bearing and locking the opposite bearing axially. Available on TEFC Blue Chip® and Blue Chip®XRI® motors. Lead-time is 3 days.

Roller to Ball Bearing

Larger horsepower motors are stocked standard with a roller bearing on the drive end. For direct-coupled applications, a ball bearing must be installed on the drive-end. Lead-time is 2 days.

Sealed Bearing

This modification provides the option of replacing the standard bearings in AC motors with sealed bearings and replacing the grease fittings with plugs. May not be suitable for belted applications. 250 - 449 frame, 3600RPM, no sealed bearing option. 250 - 445, 1800RPM and below, non contact sealed only. 48 - 215, All RPM's are available for sealed bearings. Consult Marathon Motors for full application details. Call for lead-time.

Insulated Bearing

Insulated bearings are used to reduce the transmission of shaft currents. In accordance with NEMA MG1-31.4.4.3, both bearings must be insulated to protect inverter-driven motors from inverter-sourced shaft voltages. The connected load must also be insulated from the motor shaft to prevent damage to it's bearings. Per UL, insulated bearings may **not** be installed in Division 1 or Division 2 hazardous locations. Division 2 will be removed from XRI®-Severe Duty and IEEE 841 motors when this modification is performed. Call for lead-time.

Blowers - MOD19 (Mult. Symbol S4)

Low rotational speeds, common in many vector drive applications, cause additional heat within the motor. As a result, these motors are designed as TENV or TEBC. Marathon Motors offers two types of blower units, depending upon the application requirements. The axial blower is available on Marathon's XRI® and XRI®-Severe Duty.

Axial Blower

Most TEBC requirements are satisfied with Marathon's axial blower. The blower motor and fan are in the same (horizontal) plane as the motor drive shaft. Lead-time is 3 days.

C-Face Brackets - MOD2 (Mult. Symbol S4)

The addition of a C-Face kit to a standard foot mount (rigid base) motor, results in a non-NEMA "BA" dimension in 143-256 Frames due to NEMA's establishment of two distinct "BA" dimensions for each of the affected frame sizes: one for rigid base motors and another for C-Face/rigid base motors. No motor manufacturer can meet both prescribed dimensions on reworked motors. The following table identifies the "BA" dimensions (defined as the distance from the center of the front foot hole to the shaft shoulder) for 143T-256T and TC frames:

* C-Face Kit (rework) "BA" dimension is identical to foot mount "BA."

D-Flange Brackets - MOD17

NEMA FRAME	FOOT MOUNT*	C-FACE
143T-145T	2.38"	2.75"
182T-184T	2.75"	3.50"
213T-215T	3.50"	4.25"
254T-256T	4.25"	4.75"

(Mult. Symbol S4)

Add a D-Flange Kit to rigid base, cast iron motor. Available on Blue Chip 254T-365T and Dripproof 284T-286T ("TTDP" and "TTDC" designs). Addition of D-Flange Kit results in non-NEMA 'BA' dimension or 254T-256T. Lead time is 2 days.

IEC Brackets - MOD55 (Mult. Symbol S4)

B14 FT Flange (IEC C-Face)

IEC mounting arrangement with the motor flange at the drive end similar to a NEMA C-Face motor. Modification includes motor disassembly and installation of a FT Flange to a Globetrotter® motor. Lead-time is 2 days.

B5 FF Flange (IEC D-Flange)

IEC mounting arrangement with the motor flange at the drive end similar to a D-Flange. Modification includes motor disassembly and installation of a FF Flange to Globetrotter® motor. Lead-time is 2 days.

Brake Motors - MOD3 (Mult. Symbol S4)

Spring-set, electrically released mechanical disc brakes are available for stopping and/or holding the load. Marathon's brakes are suitable for any angle mounting. Price of modification includes brake kit and installation.

MOD CENTRAL - Motor Modifications

MOTOR HP	BRAKEMOTOR SHAFT R.P.M.		
	Lb-Ft @3600	Lb-Ft @1800	Lb-Ft @1200
1/4	---	---	3
1/3	---	3	3
1/2	3	3	3
3/4	3	6	6
1	3	6	6
1 1/2	6	10	10
2	6	10	---

Brake Selection Chart

** For normal (140%) torque rating, do not apply on motors larger than 2 HP. Reduced braking torque and /or longer stopping times can result from applying an undersized brake on higher HP motors.

Brake Addition - TEFC

This modification includes the addition of a 3,6, or 10 Lb-Ft brake to single or three phase, TEFC, 56 (5000 series model numbers) and 143/145T Frame motors. Operating voltages are 115/208-230, 208-230/460, and 575 volts. Lead-time is 3 days.

Brake Addition - Inverter Duty

This modification includes the addition of a 6 or 10 Lb-Ft brake to Marathon Motors's Black Max® or Blue Max® Vector Duty motors. Operating voltages are 115/208-230, 208-230/460, or 575 volts. Lead-time is 3 days.

Brake Coil Voltage (Stearns only)

Brake coil changes allow for operation of brakes at various voltages on 50 or 60 Hertz AC power supplies. Available coil voltages at 50 HZ are 110, 220, 415, and 110/220 volts. Coil voltages at 60 HZ are 115, 200, 575, and 200/400 volts. Coil voltages at 60/50 HZ are 230/190, 460/380, and 208-230/460-190/380 volts. External brake coil lead connections will be brought out from the brake. Specify brake lead location, brake coil voltage, and supply frequency at time of order. Lead-time is 10 days.

MOD NUMBER	BRAKE RATING	BRAKE SERIES	LIST PRICE PER MOTOR
MOD3X	3 Ft/Lb	56,000	\$410
	6 Ft/Lb		
	10 Ft/Lb		
MOD3Y	15 Ft/Lb	87,000	\$510
	25 Ft/Lb		
	35 Ft/Lb		
	50 Ft/Lb		
	75 Ft/Lb		
	105 Ft/Lb		

Vertical Modification Kit (Stearns 87,000 series)

Includes required hardware to accommodate vertical above (shaft down) or vertical below (shaft up) mounting.

TORQUE RATING (Lb/Ft)	MOUNTING	
	SHAFT UP	SHAFT DOWN
25,35	Not req'd	Required
50,75,105	Required	Required

Conduit Box - MOD56 (Mult. Symbol S4)

Standard conduit box construction is based on the individual product description, e.g. severe duty motors always have a cast iron conduit box, while some standard duty motors come with stamped steel and others cast iron. Conduit boxes meet or exceed NEC 430.12 requirements for volume.

Termination of protective or monitoring devices can be provided in a separate auxiliary conduit box or conduit. Auxiliary conduit boxes are not available on explosion proof motors.

Rotate Conduit Box Lead Opening

Standard motors have lead opening facing down toward motor base. Modifications include rotating the conduit box so the lead opening is facing the desired direction. Specify lead opening location facing conduit box. Available on non-explosion proof motors. Lead-time is 2 days.

Convert to Cast Iron

Replacement of steel conduit box with a cast iron conduit box. This modification is available on non-explosion proof cast iron motors as Marathon's explosion proof integral stock motors come standard with a cast iron conduit box. Lead-time is 2 days.

Auxiliary Box (Condulet)

A condulet can be added to the main motor conduit box for routing of accessory leads. Available on ODP and TEFC (non-explosion proof) motors. Call for lead-time.

Connections - MOD0 (Mult. Symbol S4)

Motor connections consist of special cords, plugs, and switches added to a single phase motor.

Drains - MOD21 (Mult. Symbol S4)

Standard duty motors include a weep hole as standard, while severe duty and explosion proof motors include a brass drain/breather as standard. These are located in the drive end bracket at the lowest point.

Condensation Drain Holes

Additional drilled holes will be made in both end brackets of TEFC motors. Not available on explosion proof motors. Lead-time is 2 days.

Brass Drain & Breather

Combination self-draining and breather plugs are available on TEFC motors. Not available on explosion proof motors. Lead-time is 2 days.

Stainless Steel Drain & Breather

Combination self-draining and breather plugs are available on TEFC motors. Not available on explosion proof motors. Lead-time is 2 days.

Drip Covers - MOD4 (Mult. Symbol S4)

Drip covers can be furnished on standard motors for extra protection from dripping liquids and falling objects when the motor is mounted in the vertical shaft down position. These covers are recommended on all open dripproof and totally enclosed motors for vertical shaft down operation. These covers have no vertical lifting provisions provided.

MOD CENTRAL - Motor Modifications

Canopy Cover (ODP and TEFC Motors)

Modification includes installation of a sheet metal drip cover to the motor for vertical shaft down mounting. Available on rolled steel Dripproof motors through 256T frame and select TEFC motors. Lead-time is 2 days.

Encoders - MOD22, and MOD24 (Mult. Symbol E3)

These electrical devices sense rotor speed and direction providing feedback to a control device. An encoder is a feedback device that translates mechanical motion into an electrical signal. A cable is connected from the encoder to the variable frequency drive to provide this feedback. Various mechanical provisions on the motor are required to attach the encoder. These may include C-Face on the non-drive end of the motor and special shaft extension. Various resolutions are available. All encoders offered have quadrature signal with line driver output.

Encoders can be mounted on Black Max® and Blue Max® 2000 Vector Duty motors, TENV 56 through 286T Frame, TEFC construction in 284T through 449T Frame.

Stub Shaft - MOD42 (Mult. Symbol S4)

Add Stub Shaft to Fan Cooled XRI-SD, XRI-841 (182-449 Frames) to accommodate addition of encoder on opposite drive end of motor. Lead-time 2 days.

Fan - MOD43, and MOD44 (Mult. Symbol S4)

Marathon Motors's XRI® Severe Duty and IEEE841 motors have non-sparking fans made with, high-temperature, reinforced corrosion resistant plastic that is impervious to chemical attack and has been specially designed for motor applications. All motors utilize bi-directional cooling fans.

Oversized fan (Inverter Duty) - See MOD43 Inverter Duty

Fan Removal - MOD44

TEFC to TEAO. Convert a motor from totally enclosed, fan cooled construction to totally enclosed, air-over by removing fan cover, fan, and cutting off the fan end shaft. The modified motor must be mounted in the air stream of the driven fan for cooling purposes. The customer is responsible for providing adequate airflow over the motor. Lead-time is 2 days.

Vane Axial Fan - MOD43

The modification can be done on rigid or C-Face mount, TEFC, TENV, EPFC, EPNV, or DP enclosures. Motors will be modified for Vane Axial fan applications. All motors will get an additional nameplate, and 42" extended leads. TEFC models will have the fan and fan guard removed and enclosure changed to TEAO. A minimum airstream velocity of 3000' per minute is required. Lead time is 4 days.

Frequency - MOD7 (Mult. Symbol S4)

Most motors commonly operate on 60 hertz (HZ) within North America. However, 50 hertz systems are common in other countries.

Frequency Re-Rate 60 HZ to 50 HZ

Marathon Motors's standard motors rated at 60 HZ may be operated at 50 HZ at reduced voltage and horsepower or Service Factor. A label containing specific re-rating information will be attached to the motor. Frame size is subject to change. Lead-time is 1 day.

Grease/Fittings - MOD0, MOD15 (Mult. Symbol S4)

Standard grease is Exxon Polyrex® EM with a bearing operating temperature range of -30° to +150°C for ball and roller bearings. Devices for installing grease into the motors, such as zerk fittings, are available.

Grease Relief Fittings - MOD15

Install standard grease relief fitting on motor. Grease relief fittings serve as an outlet to equalize pressure in the motor. Not available on explosion proof motors. Lead-time is 2 days.

Zerk Fittings (Cast Iron Motors) - MOD15

Replace standard grease plugs on motors with zerk fittings. XRI® Severe Duty and IEEE841 motors come with zerk fittings as standard equipment. Not available on explosion proof motors. Lead-time is 2 days.

Low Temperature Grease - MOD0

Bearing grease may be changed to allow for a lower operation range. The motor bearings and end bells are purged and repacked with Beacon 325 grease or equivalent with a grease temperature range of -60°C to +120°C. Call for lead-time.

High Temperature Grease - MOD0

Bearing grease may be changed to allow for a higher operating range. The motor bearings and end bells are purged and repacked with Dow Corning DC44M grease or equivalent with a grease temperature range of -40° to +204°C. Call for lead-time.

Grounding - MOD20 (Mult. Symbol S4)

All motors 48 to 449T Frame have grounding provisions per NEMA and NEC Standards. Explosion proof motors are permitted to have a frame ground, but electrical ground in conduit box must also be connected.

Conduit Box Grounding Lug

Add clamp-type grounding lug in the conduit box. Lead-time is 2 days.

On-Frame Grounding (Cast Iron Motors)

Addition of drilled and tapped hole on conduit box side of frame with installation of grounding lug. Available on non-explosion proof cast iron ratings only. Lead-time is 2 days.

Bearing Current Protection - BCP

BCP is a shaft current mitigation system utilizing shaft ground rings for MODS. They are recommended (NEMA MG1 31.4.4.3) as an effective means of bearing protection for motors operated from inverter power. One ring is adequate to bleed down inverter-sourced shaft voltages, thereby protecting both bearings for motors as large as 5011 frame. BCP may not be installed on motors used in Division 1 or Division 2 hazardous locations or motors with a modified shaft. Does not fit all motor types. Lead-time is 2 days.

Inverter Duty - MOD25, MOD26, and MOD43 (Mult.Symbol S4)

"Inverter Duty" describes a class of motors that are capable of operation from a variable frequency drive. Many Marathon general purpose motors are suitable for most variable torque and some limited constant torque applications.

These motors do not have provisions for mounting encoders, but are suitable for use with volts/hertz or open loop vector controls. As required under Federal law, these motors comply with EPA efficiency requirements when operating from utility power. Lead-time is 2 days.

MOD CENTRAL - Motor Modifications

INV. DUTY (LEADTIME 2 DAYS)

Mod #	Appl.	Mtr. Type	Mod
25	Variable Torque	Any	Add thermostats, re-nameplate
26	10:1 CT	EPAct TEFC	Oversized fan, Add thermostats, re-nameplate
	20:1 CT	NEMA Premium® TEFC	
43	10:1 CT	EPAct TEFC	Oversized fan, re-nameplate
	20:1 CT	NEMA Premium® TEFC	

Operation of motor on VFD exempts motor from E pact mandated efficiency levels.

Leads - MOD0, MOD9, and MOD33, (Mult. Symbol S4)

All motors are provided with standard leads of ample length for easy connection in the conduit box to the power leads. Lead size and material are dependent upon the class of insulation system in the motor and the current capacity required.

Reconnection - MOD9

Reconnect dual voltage 9-lead or 12-lead motors to a 3-lead single voltage. Connection is made insided the motor frame. Specify desired voltage when ordering. On single phase motors, specify rotation. Lead-time is 2 days.

*Part Winding Start and Star-delta connections are excluded.

Remark Leads - MOD33

Using cloth markers, remark leads with numbers or letters. Please specify markings. Lead-time is 2 days.

Longer Leads - MOD0

Extend leads up to two feet longer than standard by splicing. Splice will be visible in conduit box. Not available on explosion proof motors. Lead-time is 2 days.

Mounting/Assembly - MOD1, and MOD39 (Mult. Symbol S4)

Motors listed are horizontal, foot mounted. Many stock motors can be furnished in assembly positions as illustrated. Modification may include repositioning of vents, baffles, drains, and conduit box. Also end brackets are assembled and grease fittings are properly installed for operation with the motor in the position shown. No attempt is made to locate fittings on any particular side of the motor. Horizontal ball bearing motor assemblies W5, W6, W7, and W8 are not suitable for external thrusts in excess of rotor weight and half-coupling. Cast Iron ODP and TEFC, 360 and larger, are not suitable for vertical operation. Consult Engineering for TEFC Build Up. Lead-time is 2 days.

Convert to Floor, Ceiling, or Wall Mount - MOD1

Convert standard F1 mount to F2, W1, W2, W3, W4, W5, W6, W7, W8, C1, or C2 mount. The mounting symbol is required when ordering to indicate the proper mounting. Lead-time is 2 days.

Example: Motor will be modified F1 to wall mounting W3.

FLOOR MOUNTING ASSEMBLIES

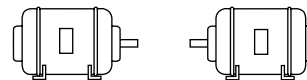

F-1

F-2

CEILING MOUNTING ASSEMBLIES

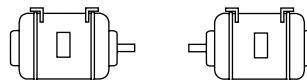

C-1

C-2

WALL MOUNTING ASSEMBLIES

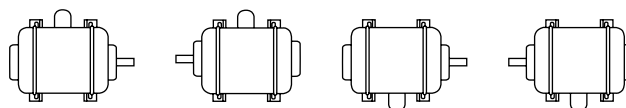

W-1

W-2

W-3

W-4

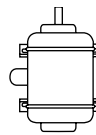

W-5

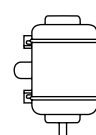

W-6

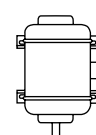

W-7

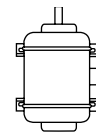

W-8

Adjustable Motor Bases - MOD39

Adjustable bases are a convenient means for adjusting belt tension or may be used as mounting plates. Adjustable motor bases are bolted to fixed base of motor prior to shipping. NEMA 215T and smaller bases feature one adjusting screw. Bases on NEMA 254T and larger feature two adjusting screws. Bases are not suitable for vertical mounting. Lead-time is 2 days.

Nameplates / Markings - MOD7 (Mult. Symbol S4)

Nameplate material is mylar or stainless steel depending on motor design and enclosure.

Additional Data on Nameplate

Motors can be re-nameplated for alternate ratings. Changes in horsepower, altitude, ambient, voltage, frequency, etc. Lead-time is 1 day.

CE Mark

CE compliant mark can be provided for all non explosion proof NEMA frame motors. Many stock motors already contain the CE mark. Lead-time is 2 days.

MOD CENTRAL - Motor Modifications

Rotation Arrow

All motors utilize bi-directional cooling fans. Specify rotation facing shaft extension on order entry form. Available on Single Phase only. Lead-time is 1 day.

Stainless Steel Nameplate

Replace existing mylar nameplate with 304 stainless steel nameplate. Lead-time is 1 day.

Separate Nameplate for Customer Data

A separate customer nameplate can be furnished. Information contained must be submitted at time of order. These additional nameplates cannot be supplied with CSA or UL Listings unless installed to motor in a Marathon Motors facility. Lead-time is 2 days.

Packaging - MOD29

(Mult. Symbol S4)

Heat Treated Pallets

ISPM-15 requires the use of heat-treated wooden packaging materials when shipping into all foreign countries (a temporary exemption exists for Canada). Modification includes replacement of wooden pallet with heat-treated pallet. Does not include export crating for ocean freight (contact factory for export packaging cost).

Paint - MOD8

(Mult. Symbol S4)

The standard paint finish is a two-coat paint system. The first coat is a rust-inhibitive primer applied to protect the castings during storage and manufacturing. The second coat is a powder coat on 48-140 frame, enamel on non-severe duty motors, or a 2-part epoxy on severe duty 180-5000 frame motors.

Special paints and color options are available if compatible and reviewed by application engineering. Paint chips and material safety data sheets are required.

Repaint to a Marathon Stock Color

Repaint motor to another Marathon Motors stock paint color. Colors include: Marathon Motors Blue Chip[®] blue, PowerWash[™] white, farm duty black, Fire Pump red, light gray, or dark gray. Specify color on order. Leadtime on enamel paint is 2 days. Epoxy paint requires a 3 day lead-time.

Screens - MOD0 (Mult. Symbol S4)

Corrosion resistant screens can be furnished over the air intake and discharge openings of cast iron dripproof motors. Dripproof motors equipped with these screens conform to the dripproof guarded definition appearing in NEMA MG-1, Part 1. Call for lead time.

Service Factor - MOD7 (Mult. Symbol S4)

A multiplier that may be applied to the rated horsepower of a motor, which indicates a permissible horsepower loading at rated voltage and frequency. Lead-time is 1 day.

AC Motor Service Factor Re-Rating

When a 1.15 Service Factor or higher is required, please refer to the list adder. Frame size is subject to change. Not available on explosion proof motors. Lead-time is 1 day.

Severe Duty Construction - MOD16

(Mult. Symbol S4)

This modification starts with a Marathon Blue Chip[®] Totally Enclosed cast iron frame motor and reworks it to all cast iron construction. With additional enhancements, the motor is prepared for a severe or harsh industrial environment. (Domestic Built Product Only)

Remove polypropylene fan cover and sheet metal conduit box from the motor and replace with cast iron fan cover, threaded and gasketed conduit box, apply epoxy finish to motor exterior, and add brass drain and breather. Lead-time is 2 days.

Shaft Modification - MOD0, and MOD42

(Mult. Symbol S4)

Motors are furnished with a single straight shaft with sled runner keyway and a rectangular key. For motors in frames 143T through 449T, a long shaft for V-Belt drive is supplied. 2-Pole motors in frames 324 through 449 and certain other 4-Pole ratings are furnished with short shafts for direct connections. Modifications are for existing shafts only. Not applicable if a new shaft is required.

Drill & Tap Hole - MOD42

Drilled radially or in the end of the shaft. Drilled and tapped in the end of the shaft. Lead-time is 3 days.

TS Shaft - MOD42

Convert "T" frame shaft to a "TS" Frame shaft. Modify motor by reducing the shaft, adding new keyway, and shortening the shaft length to the NEMA "TS" dimension. Lead-time is 3 days.

Mill Flat on Shaft - MOD0

Mill a flat on the drive end shaft extension. Provide detail of flat with the order. Lead-time is 3 days.

Steps on Shaft - MOD0

One to three reductions in shaft diameter. Customer to specify number of reductions at time of order. Call for lead time.

MOD CENTRAL - Motor Modifications

Space Heaters - MOD12, and MOD41

(Mult. Symbol S4)

Space heaters are used to prevent the build-up of condensation on the windings of the motor when the motor is not operating. Space heaters are typically installed on the end-turns of the coils.

Space Heaters - ODP & TEFC - MOD12

Space heaters can be furnished on dripproof and totally enclosed motors. Heater leads are normally brought out to the motor conduit box. Heater voltage is available in three voltages for 60 Hz operation of 115, 230, or 460 volt, single-phase. Space heaters are sized per NEMA standards.

Lead-time is 2 days.

Space Heaters - IEC Frames - MOD12

Space heaters can be furnished on IEC motors. Heater leads are normally brought out to the main terminal box. Heater voltage is available in two voltages for 50 Hz operation.

Lead-time is 2 days.

Space Heaters - Explosion Proof - MOD41

Space heaters can be furnished on explosion proof motors. Heater leads are normally brought out to the motor conduit box. Heater voltage is available in three voltages for 60 Hz operation of 115, 230, or 460 volt, single-phase. Space heaters are sized per NEMA standards.

Lead-time is 2 days.

Terminal Blocks - MOD0 (Mult. Symbol S4) Conduit box mounted terminal blocks provide for a convenient termination of power leads. The terminal blocks are sized for the proper amperage and voltage of the motor. The Globetrotter® IEC motor has IEC terminal blocks as standard.

Terminal Block

Install terminal blocks in conduit box of NEMA motor with lead connection. Customer to advise on lead connection. Call for lead-time. Contact factory to verify capability.

Thermal Protection - MOD0, and MOD14

(Mult. Symbol S4)

Thermal protection are built in protective devices that prevent motor overheating. They work either by interrupting the power supply when the motor overheats or by incorporating a pilot device that opens the holding circuit of a magnetic starter or energizes an alarm bell or warning light.

Thermostats - All Motors - MOD14

Thermostats are mounted on the stator winding and are temperature-sensing only, with normally closed snap action contacts. These devices are installed on the end-turns of the motor winding. Their purpose is to activate a warning device or shut down the motor upon excessive winding temperatures. The standard arrangement is the addition of 2 or 3 thermostats to the winding end-turns, connected in series with the leads brought out to the main motor conduit box. Class I Groups C & D / Class II Groups F & G Explosion Proof motors have hermetically sealed thermostats as standard.

Lead-time is 2 days.

Thermistors - All Motors - MOD14

Thermistors are small, non-linear resistance devices placed on the stator windings. As the critical temperature is reached, the resistance of the thermistor changes radically, causing operation of a control relay. The standard arrangement is Q-3 positive temperature coefficient (PTC) type on winding end-turns with leads brought out to the main motor conduit box. On IEC motors the leads are brought into a conduit adjacent to the main conduit box and includes a terminal block. As standard, 3 Texas Instrument thermistors are furnished, one per phase. Control Module is available.

Lead-time is 2 days.

Thermocouples - Non XP Motors - MOD0

Thermocouples sense temperature and offer inherent protection against abnormal stall and running conditions. The standard arrangement is the addition of an iron constantan thermocouple to the winding end turns or bearing housing with leads brought out to the main motor conduit box. Customer must specify number, type, and location at time of order.

Lead-time is 2 days.

Weatherproofing/Special Service

MOD5, and MOD49

(Mult. Symbol S4)

Weatherproofing or special service provides additional protection to windings and mechanical parts as well as special greases or modifications per industry specifications such as NEMA, or IEEE. Call for lead-time.

Tropical Anti-Fungus Treatment - MOD5

Windings and mechanical parts coated with polyurethane for superior protection to resist tropical environments. Not available on brake motors.

Lead-time is 2 days.

Hazardous Duty™ Service

Division 2 Hazardous Motors - MOD49

The Division 2 hazardous modification incorporates a new fan, fan guard, and nameplate on most TEFC motors. XRI®-SD and IEEE841 motors have Division 2 statement on the nameplate as standard. The nameplate will say "CSA Certified, Group I, Division 2, Groups A, B, C, and D, Temperature Code.

(See chart below) Call for lead-time.

NEMA FRAME	SERVICE FACTOR	POWER SUPPLY	FREQUENCY RANGE	TEMP CODE
143-449T	1.0	SineWave	50-60Hz	T3
143-449T	1.0	PWM	3-120Hz	T2D
143-449T	1.15	SineWave	60Hz	T2B

Accessory Kits - Index

DESCRIPTION	PAGE NUMBER
Bases	
• Adjustable Motor Bases-----	223
• Transition Bases -----	223
Bearings	
• Ball Bearing Conversion Kits-----	220
• Roller Bearing Conversion Kits-----	220
Blower	
• Axial Blower Kits -----	220
Bracket	
• C-Face Kits - Dripproof -----	209
• C-Face Kits - NEMA Premium / Globetrotter Dripproof-----	209
• C-Face Kits - Totally Enclosed-----	210
• C-Face Kits - XRI® IEEE 841 -----	211
• D-Flange Kits-----	211
• FF (B5) Flange (IEC D-Flange)-----	212
• FT (B14) Flange (IEC C-Face) -----	212
• Metric Flanges to Reduce Diameter-----	212
Brakes	
• Brake Kits - Single and Three Phase-----	213
• Brake Kits - Inverter Duty (Black Max® and Blue Max®)-----	213
• Double C-Face Coupler Brake-----	213
• Vertical Modification Kit-----	213
Capacitor Kits	
• Capacitor Mounting Kit -----	216
• Capacitor with Mounting Kit-----	216
• Oval Run Capacitors-----	216
• Capacitor Selection Guide-----	217
Conduit Box	
• Cast Iron Conduit Box Kits -----	218
Drip Covers	
• Motor Rainshield/Fan Canopy-----	218
• Drip Cover Kits (48-256T Frame) -----	218
Encoders, Cables, and Stub Shaft	
• Avtron - Black Max® / Blue Max® -----	221
• BEI - Black Max® / Blue Max® -----	221
• Dynapar - Black Max® / Blue Max® -----	221
• EPC - Black Max® / Blue Max®-----	221
• Northstar - Black Max® / Blue Max®-----	221
• Turck - Black Max® / Blue Max®-----	221
• Danaher Controls (Cable Kits)-----	221
• Encoder Stub Shaft Kit (XRI®-SD & XRI®-841,TEFC only)-----	221

Accessory Kits - Index

DESCRIPTION	PAGE NUMBER
Explosion Proof	
• Explosion Proof Conduit box	218
• Lead Exit Reducer	218
Grounding	
• AEGIS - Shaft Grounding Ring Kits	222
• Conductive Epoxy	222
• Replacement Ground Brush Parts	222
Mounting	
• 48 Frame Lug Mount Kits	215
• Fedders Adapter Plate	216
• Fedders Mounting Kit	216
• Length Adapter Kit	216
• Resilient Base Latches	215
• Resilient Base (includes latches)	214
• Resilient Mounting Kit	214
• Resilient Ring Kit	214
• Rheem/Ruud Mounting Kit	216
• Rubber Mounting Hardware	215
• Split Mounting Rings	215
5K Motor Accessories	
• Base Plates	219
• Bearings	219
• C-Face Endsheids	219
• Capacitors	219
• imPower Signal Cord	219
• ODE Endsheids	219
• Square Flange Endsheids	219
• Start Mechanisms	219
• Switches	219
• Voltage Change Plug	219
• Pump Motor Rainshield Kit	219
Severe Duty Construction (Upgrade Kits)	
• Cast Iron Fan Cover and Conduit Box Kits	220
Shaft Kits	
• Blower Wheel Remover	217
• Brass Punch	218
• Encoder Stub Shaft Kit (XRI®-SD & XRI®-841, TEFC only)	221
• Shaft Adapter Sleeve	217
• Shaft Lock Device	217
• Tapered Fork	217
Switches	
• Toggle Switches	217
Terminal Block Kits	
• Terminal Block Kits - 182 to 449 Frames	212

Accessory Kits - Multiplier Symbol S4



Complete kits with hardware necessary for converting Marathon stock rigid base motors to "C-Face" mounting with rigid base.

Excludes Blue Chip® XRI® Dripproof stock motors, see below

C-Face Kits - Dripproof (Standard and EAct Efficiency)

CAT. NO.	FRAME	KIT NO.	LIST PRICE	WHERE USED (Models Containing)	WEIGHT	FOOT NOTES
A435	56	KIT 56CDR-1	\$37	A 6203 (17mm) bearing	3	
AG212	56	161L185AAG1	\$37	A 6203 bearing (5K Type, 30 Frame)	3	
A534	56	161L187BAG1	\$37	A 6203 bearing (5K Type, 40 Frame)	3	
A436	56-143T-145T	KIT 140TCDR-1	\$69	A 6205 (25mm) bearing	3	75
A535	143T-145T	161L187BCG1	\$69	A 6205 bearing (5K Type, 40 Frame)	3	75
A666	182T-184T	KIT 175691	\$102	TTDW, TBDW, or TCDW	14	75
A606	213T-215T	KIT 210TCDW	\$143	TTDW, TBDW, or TCDW	13	75
A612	254T-256T	KIT 250TCDX	\$165	TTDX	13	75
A610	284T-286T/TS	KIT 280TCDP	\$306	TTDP or TSTD P	30	75
A287	284T-286T/TS	KIT 280TCD C	\$306	TTDC/N	38	75
A1287	284T-286T/TS	KIT 280TCDCA	\$306	TTDCA	45	75
A613	324T-326T/TS	KIT 320TCDP	\$530	TTDC/P or TSTD C/P	43	
A216	364T-365T	KIT 360TCDS	\$673	TTDC/S	71	
A219	364TS-365TS	KIT 360TSCDS	\$673	TSTD C/S	62	
A222	404T-405T	KIT 400TCDS	\$736	TTDS	82	
A225	404TS-405TS	KIT 400TSCDS	\$736	TSTD S	89	
A228	444T-445T	KIT 440TCDS	\$1,408	TTDS	116	
A231	444TS-445TS	KIT 440TSCDS	\$1,408	TSTD S	119	
A293	447TS/449TS	KIT 440TSCDN	\$1,408	TSTD N	144	

C-Face Kits - XRI Blue Chip® NEMA Premium and Globetrotter Dripproof

CAT. NO.	FRAME	KIT NO.	LIST PRICE	WHERE USED (Models Containing)	WEIGHT	FOOT NOTES
A600	143T-145T	KIT 175181	\$69	U244, U245, U246, U265, U758, U759, and U760	5	75
A436	143T-145T	KIT 140TCDR-1	\$69	E927, E928, and E929	3	75
A160	182T-184T	KIT 180TCD-WD	\$102	TTDB (2,4 and 6 pole)	14	75
A602	213T-215T	KIT 175066	\$143	U268, U269, U763, U764, U765, and U766	18	75
A161	213T-215T	KIT 210TCD-WD	\$143	TTDB (2,4 and 6 pole)	22	75
A622	254T-256T	KIT 175067	\$165	U254, U255, U767, U768, U769, and U770	27	75
A162	254T-256T	KIT 250TCD2-WD	\$165	TTDCA (2 pole only)	32	75
A163	254T-256T	KIT 250TCD-WD	\$165	TTDCA (4 and 6 pole only)	32	75
A626	284T-286T	KIT 175058	\$306	U256, U257, U771, U772, U773, and U774	32	75
A164	284TS-286TS	KIT 280TCD2-WD	\$306	TSTDCA (2 pole only)	38	75
A165	284T-286T	KIT 280TCD-WD	\$306	TTDCA (4 and 6 pole only)	38	75
A627	324T-326T	KIT 175059	\$530	U775, U776, U777, U778, U798 and U799	39	
A166	324TS-326TS	KIT 320TCD2-WD	\$530	TSTDCA (2 pole only)	45	
A167	324T-326T	KIT 320TCD-WD	\$530	TTDCA (4 and 6 pole only)	45	
A628	364T-365T	KIT 175060	\$673	U779, U782, U783, U784, U927, and U928	56	
A629	364T-365T	KIT 175601	\$673	U1779, U1782, U1783, U1784, U1927, and U1928	56	
A216	364T-365T	KIT 360TCDS	\$673	E921	71	
A168	364TS-365TS	KIT 360TCD2-WD	\$673	TSTD CB (2 pole only)	85	
A169	364T-365T	KIT 360TCD-WD	\$673	TTDCB (4 and 6 pole only)	85	
A222	404T-405T	KIT 400TCDS	\$736	E922, E923, U270, and U271	82	
A225	404TS-405TS	KIT 400TSCDS	\$736	U250 and U251	89	
A414	404TS-405TS	KIT 400TCD2-WD	\$736	TSTD C (2 pole only)	95	
A415	404T-405T	KIT 400TCD-WD	\$736	TTDC (4 and 6 pole only)	95	
A228	444T-445T	KIT 440TCDS	\$1,408	U272, U273, E924, E925 and E926	116	
A416	444TS-445TS	KIT 444/5TCD2-WD	\$1,408	TSTD C (2 pole only)	140	
A417	444T-445T	KIT 444/5TCD-WD	\$1,408	TTDC (4 and 6 pole only)	140	
A419	447T-449T	KIT 447/9TCD-WD	\$1,408	TTDC (6 pole only)	140	

All Kits Listed on This Page are Stock

Accessory Kits - Multiplier Symbol S4



Complete kits with hardware necessary for converting Marathon stock rigid base motors to "C-Face" mounting with rigid base. Includes Globetrotter, XRI (AS NOTED), and Severe Duty.

Excludes Blue Chip® XRI® IEEE-841 stock motors, available on the next page.

C-Face Kits - Totally Enclosed

CAT. NO.	FRAME	KIT NO.	LIST PRICE	WHERE USED (Models Containing)	WEIGHT	FOOT NOTES
A437	56	KIT 56CFR-1	\$37	A 6203 (17mm) bearing (standard frame)	3	
AG215	56	161L186AAG1	\$37	A 6203 bearing (5K Type, 30 Frame)	3	
A536	56	161L188BAG1	\$37	A 6203 bearing (5K Type, 40 Frame)	3	
A438	56-143T-145T	KIT 140TCFR-1	\$69	A 6205 (25mm) bearing or TBFR, TCFR, TTTR, or TTFR	5	75
A537	140T	161L188BCG1	\$69	A 6205 bearing (5K Type, 40 Frame)	5	75
A603	143T	KIT 143TCFN	\$69	TTFN, TTTC, or TTTN	5	75,76
A642	56-143T-140T	KIT 175077	\$69	Use on 56-140 frame XRI-NEMA Premium rolled steel models	5	75
A655	145T	KIT 145TCFN	\$69	TTFN, TTTC, or TTTN	5	75,76
A170	182T-184T	KIT 180TCF-WD	\$102	TTFBA (GLOBETROTTER)	14	75
A640	182T-184T	KIT 180TCN4.5	\$102	TTFN (Non-Std. 4-1/2" ak dim)	14	75
A641	182T-184T	KIT 180TCN8.5	\$102	TTFN (8-1/2" AK)	14	75
A643	182T-184T	KIT 175296	\$102	Use on model numbers 182/4TTFR4026 (8-1/2" AK)	14	75
A644	182T-184T	KIT 180CF8.5-1	\$102	TTTL/S, TCFL/R, TTFC (Not XRI)/L/R/S or THTS (Standard 8-1/2" AK dim.)	14	75
A645	182T-184T	KIT 180CF4.5-1	\$102	TTFC (Not XRI)/L/R/S (Non-Std. 4-1/2" AK dim.)	14	75
A666	182T-184T	KIT 175691	\$102	TCFW, TBFV, TTFV	14	75
A171	213T-215T	KIT 210TCF-WD	\$143	TTFBA (GLOBETROTTER)	22	75
A204	213T-215T	KIT 210TCFL	\$143	TTFL/R or TBFL	17	75
A206	213T-215T	KIT 210TCFS	\$143	TTFC (Not XRI)/S, THFS, TTTS and THTS (except 213/5TTFC4075)	17	75
A609	213T-215T	KIT 210TCFV	\$143	TBFV, TTFV	17	75
A646	213T-215T	KIT 210TCN	\$143	TTFN	17	75
A652	213T-215T	KIT 175068	\$143	Use on models 213TTFC4076 and 215TTFC4076	17	75
A667	213T-215T	KIT 175844	\$143	XRI-NEMA Premium models containing TTFW1	17	75
A172	254T-256T	KIT 250TCF2-WD	\$165	TTFCA (2 pole only)(GLOBETROTTER)	32	75
A173	254T-256T	KIT 250TCF-WD	\$165	TTFCA (4 and 6 pole only)(GLOBETROTTER)	32	75
A209	254T-256T	KIT 250TCFL	\$165	TTFL, and THTL (254TTFL4076)	21	75
A1209	254T-256T	KIT 250TCFL-R	\$165	TTFL1 and THTL1 (current frame design) (254TTFL14076)	21	75
A284	254T-256T	KIT 250TCFNA	\$165	TTFNA, and THTNA	35	75
A239	254T-256T	KIT 250TCFPA	\$165	TTFPA, THTPA, and TSTFPA	35	75
A601	254T-256T	KIT 250TCFP	\$165	TTFC (Not XRI, or 254/6TTFC4076)	35	75
A653	254T-256T	KIT 175191	\$165	Use on model numbers 254TTFC4076 and 256TTFC4076	21	75
A174	284TS-286TS	KIT 280TCF2-WD	\$306	TSTFCA (2 pole only)(GLOBETROTTER)	38	
A611	284T-286T/TS	KIT 280TCFP	\$306	TTFC (Not XRI)/P, THFP, TSTFP or TSTFC (except 284/6TTFC4076)	31	
A615	284T-286T/TS	KIT 280TCFN	\$306	TTFN or TSTFN	52	
A617	284T-286T/TS	KIT 280TCFPA	\$306	TTFPA, THFPA, and TSTFPA	45	
A618	284T-286T/TS	KIT 280TCFNA	\$306	TTFNA, THFNA, or TSTFNA	55	
A654	284T-286T	KIT 175061	\$306	Use on model numbers 284TTFC4076 and 286TTFC4076	31	
A175	284T-286T	KIT 280TCF-WD	\$306	TTFC (4 and 6 pole)(GLOBETROTTER)	38	
A176	324TS-326TS	KIT 320TCF2-WD	\$530	TSTFCA (2 pole only)(GLOBETROTTER)	45	
A214	324T-326T/TS	KIT 320TCFS	\$530	TTFS, THFS, or TSTFS	90	
A614	324T-326T/TS	KIT 320TCFP	\$530	TTFC (Not XRI)/P, THFP, TSTFP or TSTFC (Not XRI)	50	
A619	324T-326T/TS	KIT 320TCFPA	\$530	TTFPA, THFPA, AND TSTFPA	57	
A177	324T-326T	KIT 320TCF-WD	\$530	TTFCA (4 and 6 pole only) (GLOBETROTTER)	45	
A178	364TS-365TS	KIT 360TCF2-WD	\$673	TSTFCA (2 pole only)(GLOBETROTTER)	85	
A396	364TS-365TS	KIT 360TSCFSR	\$673	TSTFS or TSHFS	105	
A217	364T-365T	KIT 360TCFS	\$673	TTFC (Not XRI)	105	
A179	364T-365T	KIT 360TCF-WD	\$673	TTFCA (4 and 6 pole only)(GLOBETROTTER)	85	
A395	364T-365T	KIT 360TCFSR	\$673	TTFS or THFS	105	
A226	404TS-405TS	KIT 400TSCFS	\$736	TSTFS or TSHFS	125	
A424	404TS-405TS	KIT 400TCF2-WD	\$736	TSTFC (2 pole only)(GLOBETROTTER)	175	
A223	404T-405T	KIT 400TCFS	\$736	TTFS or THFS	125	
A425	404T-405T	KIT 400TCF-WD	\$736	TTFC (4 and 6 pole only)(GLOBETROTTER)	175	
A232	444TS-445TS	KIT 440TSCFS	\$1,408	TSTFS or TSHFS	105	
A426	444TS-445TS	KIT 444/5TCF2-WD	\$1,408	TSTFC (2 pole only)(GLOBETROTTER)	225	
A621	444TS-445TS	KIT 440TSCFN	\$1,408	TSTFN or TSHFN	200	
A229	444T-445T	KIT 440TCFS	\$1,408	TTFS or THFS	175	
A427	444T-449T	KIT 444/5TCF-WD	\$1,408	TTFC (4 and 6 pole only)(GLOBETROTTER)	225	
A620	444T-445T	KIT 440TCFN	\$1,408	TTFN or THFN	205	
A428	447/9TS	KIT 447/9TCF2-WD	\$1,408	TSTFC (2 pole only)(GLOBETROTTER)	250	
A624	447/9TS	KIT 449TSCFS-1	\$1,408	TSTFS (6313 bearing), 2-Pole	200	
A625	447/9TS	KIT 449TSCFS-2	\$1,408	TSTFS (6318 bearing) 4-, 6-, and 8-Pole	200	
A623	447/9T	KIT 449TCFS	\$1,408	TTFS or THFS with ball bearings	200	

All Kits Listed on This Page are Stock

Accessory Kits - Multiplier Symbol S4

Complete Kits with hardware and Inpro/Seal® necessary for converting Marathon stock IEEE-841 rigid base motors to "C-Face" mounting with rigid base.

C-Face Kits - Blue Chip® XRI® IEEE-841 Motors

CAT. NO.	FRAME	KIT NO.	LIST PRICE	WHERE USED (Models Containing)	WEIGHT	FOOT NOTES
A181	143T	KIT 143TCTN - 841	\$146	THTN	9	75,76
A262	145T	KIT 145TCTN - 841	\$146	THTN	9	75,76
A182	182T - 184T	KIT 180TCFS - 841	\$206	THTS or THFS	13	75
A183	213T - 215T	KIT 210TCFS - 841	\$278	THTS or THFS	16	75
A184	254T - 256T	KIT 250TCFNA - 841	\$318	THFNA	35	75
A185	284T/TS-286T/TS	284T/TS-286T/TS	\$596	THFN	52	
A186	284T/TS-286T/TS	284T/TS-286T/TS	\$596	THFNA	52	
A187	324T/TS-326T/TS	324T/TS-326T/TS	\$978	THFS	89	
A188	364T - 365T	KIT 360TCFSR - 841	\$1,224	THFS	95	
A189	364TS - 365TS	KIT 360TSCFSR - 841	\$1,224	TSHFS	95	
A190	404T - 405T	KIT 400TCFS - 841	\$1,344	THFS	129	
A191	404TS-405TS	KIT 400TSCFS-841	\$1,344	TSHFS	118	
A192	444T - 445T	KIT 440TCFS - 841	\$1,869	THFS	175	
A193	444TS - 445TS	KIT 440TSCFS - 841	\$1,869	TSHFS	108	
A194	444T - 445T	KIT 440TCFN - 841	\$1,869	THFN	201	
A195	444TS - 445TS	KIT 440TSCFN - 841	\$1,869	TSHFN	199	

D-Flange Kits

Complete kits with hardware necessary for converting Marathon **stock rigid base** motors to D-Flange mounting with rigid base.

CAT. NO.	FRAME	ENCLOSURE	KIT NO.	LIST PRICE	WHERE USED (Models Containing)	WEIGHT	FOOT NOTES
A647	254T-256T	TEFC	KIT 250TDFPA	\$407	TTFPA	21	97
A648	254T-256T	TEFC	KIT 250TDFNA	\$407	TTFNA	15	97
A649	254T-256T	TEFC	KIT 649R	\$407	TTFP or TTFC (EPAct)	39	97
A650	284T/TS-286T/TS	DRIPPROOF	KIT 650R	\$715	TTDP,TTDC (EPAct),TSTDPA or TSTDPA (EPAct)	38	
A651	284T/TS-286T/TS	TEFC	KIT 651R	\$715	TTFP, TTFC (EPAct), TSTFP or TSTFC (EPAct)	38	
A656	284T-286T	TEFC	KIT 280TDFNA	\$715	TTFNA	60	97
A658	324T/TS-326T/TS	TEFC	KIT 320TDFS	\$808	TTFs, TSTFS	118	
A657	324T-326T	TEFC	KIT 320TDFPA	\$808	TTFPA or TSTFPA	83	97
A637	364T-365T	TEFC	KIT 360TDFC	\$954	TTFC (EPAct)	121	

Complete kits with hardware necessary for converting Marathon **stock C-Face rigid base** motors to D-Flange mounting with rigid base.

CAT. NO.	FRAME	ENCLOSURE	KIT NO.	LIST PRICE	WHERE USED (Models Containing)	WEIGHT
A630	182TC-184TC	TEFC	KIT 180TDFR	\$160	TTFR	17
A631	284TC-286TC	TEFC	KIT 280TDFP	\$716	TTFP	15
A632	324TC-326TC	TEFC	KIT 320TDFP	\$876	TTFP	71
A634	405TC	TEFC	KIT 400TDFS	\$1,194	TTFs	149

All Kits Listed on This Page are Stock

Accessory Kits - Multiplier Symbol S4

IEC Mounting Kits

Complete kits with hardware necessary for converting Marathon IEC stock motors to B5 and B14 mountings.

Flange Mounting Kits For Aluminum Frame Motors Only

FRAME	POLE	FLANGE	CAT. NO.	KIT NO.	LIST PRICE	BOLT CIRCLE "mm"	WEIGHT
63	ALL	FF/B5	A569	KIT 635115	\$53	115	15
	ALL	FT/B14	A561	KIT 631475	\$48	75	
71	ALL	FF/B5	A570	KIT 715130	\$62	130	15
	ALL	FT/B14	A562	KIT 711485	\$53	85	
80	ALL	FF/B5	A571	KIT 805165	\$67	165	25
	ALL	FT/B14	A563	KIT 8014100	\$59	100	
90	ALL	FF/B5	A572	KIT 905165	\$71	165	25
	ALL	FT/B14	A564	KIT 9014115	\$65	115	

Flange Mounting Kits For Cast Iron Frame, NEMA Premium (IE3) Motors Only

FRAME	POLE	FLANGE	CAT. NO.	KIT NO.	LIST PRICE	BOLT CIRCLE "mm"	WEIGHT
100	ALL	FF/B5	A554A	KIT 175810	\$94	215	16
		FT/B14	A581A	KIT 175817	\$86	130	10
112	2 & 4	FF/B5	A555B	KIT 175827	\$101	215	33
		FT/B14	A582B	KIT 175832	\$94	130	13
112	6	FF/B5	A554A	KIT 175810	\$94	215	33
		FT/B14	A581A	KIT 175817	\$86	130	13
132	2	FF/B5	A550	KIT 175828	\$134	265	20
		FT/B14	A589	KIT 175833	\$125	165	16
132	4 & 6	FF/B5	A556A	KIT 175812	\$134	265	20
		FT/B14	A583A	KIT 175819	\$125	165	16
160	2	FF/B5	A551	KIT 175829	\$254	300	33
		FT/B14	A590	KIT 175834	\$265	215	30
160	4 & 6	FF/B5	A557	KIT 175990	\$254	300	33
		FT/B14	A584	KIT 175991	\$265	215	30
180	2	FF/B5	A552	KIT 175830	\$347	300	41
		4 & 6	A558	KIT 175890	\$347	300	41
200	2	FF/B5	A553	KIT 175831	\$411	350	61
		4 & 6	A559	KIT 175994	\$411	350	61
225	ALL	FF/B5	A580	KIT 175995	\$718	400	76
250	ALL	FF/B5	A594	KIT 175619	\$921	400	165
280	ALL	FF/B5	A596	KIT 175835	\$1,152	500	201
315	ALL	FF/B5	A598	KIT 175836	\$1,454	600	232

Flange Mounting Kits For Cast Iron Frame, EPAct (IE2) Motors Only

FRAME	FLANGE	CAT. NO.	KIT NO.	LIST PRICE	BOLT CIRCLE "mm"	WEIGHT	STYLE LETTER*
100	FF/B5	A573	KIT 1005215	\$94	215	16	None
		A554	KIT 175984	\$94	215	16	A
100	FT/B14	A565	KIT 10014130	\$86	130	10	None
		A581	KIT 175985	\$86	130	10	A
112	FF/B5	A574	KIT 1125215	\$101	215	33	None
		A555	KIT 175986	\$101	215	33	A
112	FT/B14	A566	KIT 11214130	\$94	130	13	None
		A582	KIT 175987	\$94	130	13	A
132	FF/B5	A575	KIT 1325265	\$134	265	20	None
		A556	KIT 175988	\$134	265	20	A
132	FT/B14	A567	KIT 13214165	\$125	165	16	None
		A583	KIT 175989	\$125	165	16	A
160	FF/B5	A576	KIT 1605300	\$254	300	33	None
		A557	KIT 175990	\$254	300	33	A
160	FT/B14	A568	KIT 16014215	\$245	215	30	None
		A584	KIT 175991	\$308	215	30	A
180	FF/B5	A577	KIT 1805300	\$315	300	33	None
		A558	KIT 175890	\$347	300	41	A
200	FF/B5	A578	KIT 2005350	\$411	350	45	None
		A559	KIT 175994	\$411	350	61	A
225	FF/B5	A579	KIT 2255400	\$526	400	60	None
		A580	KIT 175995	\$718	400	76	A

** Style letter refers to the 8th position in the motor model number.
Ex: 132STFCA4526

Metric Flanges To Reduce Diameter For Aluminum Frame Motors Only

MOTOR FRAME	NEW FRAME DIA.	CAT. NO.	KIT NO.	KIT ONLY LIST PRICE	WEIGHT
63	56	A585	KIT 175900	\$44	5
71	63	A586	KIT 175901	\$50	5
80	71	A587	KIT 175902	\$56	8
90	80	A588	KIT 175903	\$59	8

Terminal Block Kits

Terminal blocks provide for a convenient termination for power leads, and are sized for the proper amperage and voltage of the motor. These kits fit domestically produced NEMA TEFC, TENV, and ODP motors equipped with cast iron conduit boxes. Available on 182 to 449 frames.

CAT. NO.	FRAME	KIT NO.	LIST PRICE	WEIGHT
A1000	180-210	KIT 180-210 TERM BLK	\$101	2
A1001	250-320	KIT 250-320 TERM BLK	\$123	3
A1002	360	KIT 360 TERM BLK	\$168	5
A1003	404-445	KIT 400-445 TERM BLK	\$168	7
A1004	447/449	KIT 447/9 TERM BLK	\$243	10

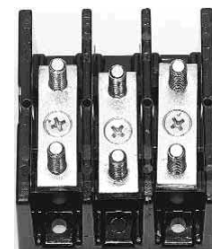

All Kits Listed on This Page are Stock

Accessory Kits - Multiplier Symbol S4 (except as noted)

Brake Kits - Single and Three Phase Motors

Stearns 56000 Series Brake Kits

These kits include a brake mounted to an external cast aluminum fan guard. Designed for easy field installation on Marathon's Four-In-One motors, 56, 143 and 145 frames only.

TORQUE RATING (Lb-Ft)	LIST PRICE	115/208-230 VOLT		208-230/460 VOLT		575 VOLT		WEIGHT ALL
		CAT. NO.	KIT NO.	CAT. NO.	KIT NO.	CAT. NO.	KIT NO.	
3	\$398	A306	KIT 3BRK1	A301	KIT 3BRK3	A297	KIT 3BRK3A	10
6	\$469	A307	KIT 6BRK1	A302	KIT 6BRK3	A298	KIT 6BRK3A	11
10	\$580	-	-	A303	KIT 10BRK	A299	KIT 10BRKA	10

Selection Chart
(Used to select brake size)

MOTOR HP	BRAKEMOTOR SHAFT RPM		
	LB-FT @3600	LB-FT @1800	LB-FT @1200
1/4	—	—	3
1/3	—	3	3
1/2	3	3	3
3/4	3	6	6
1	3	6	6
1-1/2	6	10	10
2	6	10	—

Dings Brake Kits

These kits include a brake mounted to an external cast aluminum fan guard. Designed for easy field installation on Marathon's Four-In-One motors, 56, 143 and 145 frames only.

TORQUE RATING (Lb-Ft)	LIST PRICE	115/230 VOLT		208-230/460 VOLT		575 VOLT		WEIGHT ALL
		CAT. NO.	KIT NO.	CAT. NO.	KIT NO.	CAT. NO.	KIT NO.	
3	\$398	A1306	KIT BRK-3 115/230	A1301	KIT BRK-3 208-230/460	A1297	KIT BRK-3 575	3
6	\$469	A1307	KIT BRK-6 115/230	A1302	KIT BRK-6 208-230/460	A1298	KIT BRK-6 575	10
10	\$580	-	-	A1303	KIT BRK-10 208-230/460	A1299	KIT BRK-10 575	10

Stearns 56000 Series Brake Kits - Inverter Duty TENV Black Max® and Blue Max® Motors - Multiplier Symbol E3

For normal (140%) torque rating, do not apply on motors larger than 2 HP. Reduced braking torque and/or longer stopping times can result from applying an undersized brake on higher HP motors.

These brake kits fit on both Black Max® and Blue Max® TENV motors (See pages 89 and 91). These can also be used together with the Double C-Face SL56 encoder to make a closed loop inverter brake motor.

TORQUE RATING (Lb-Ft)	LIST PRICE	115/208-230 VOLT		208-230/460 VOLT		575 VOLT		WEIGHT ALL
		CAT. NO.	KIT NO.	CAT. NO.	KIT NO.	CAT. NO.	KIT NO.	
6	\$715	A317	KIT BM6BRK115	A312	KIT BM6BRK	A315	KIT BM6BRK575	7
10	\$868	A318	KIT BM10BRK115	A313	KIT BM10BRK	A316	KIT BM10BRK575	7

See page 202 for encoder kits to install between the motor and brake.

Vertical Modification Kit (Stearns 87,000 series)

Includes required hardware to accommodate vertical above (shaft down) or vertical below (shaft up) mounting.

TORQUE RATING (Lb/Ft)	MOUNTING		CAT. NO.	MODEL NO.	LIST (KITS ONLY)	WEIGHT
	SHAFT UP	SHAFT DOWN				
25,35	Not req'd	Required	A157	KIT VRT87BRK	\$420	3
50,75,105	Required	Required				

Double C-Face Coupler Brakes

Includes a 5/8" sleeve

TORQUE RATING (Lb/Ft)	ENCLOSURE NEMA 2, IP-23 208-230/460V			ENCLOSURE NEMA 4, IP-54 208-230/460V			ENCLOSURE NEMA 4X, IP-55 208-230/460V			WEIGHT ALL
	CAT. NO.	KIT NO.	LIST PRICE	CAT. NO.	KIT NO.	LIST PRICE	CAT. NO.	KIT NO.	LIST PRICE	
3	A903	KIT 903	\$530	A906	KIT 906	\$652	A909	KIT 909	\$755	12
6	A904	KIT 904	\$591	A907	KIT 907	\$736	A910	KIT 910	\$816	12
10	A905	KIT 905	\$673	A908	KIT 908	\$816	A911	KIT 911	\$897	12



All Kits Listed on This Page are Stock

Accessory Kits - Multiplier Symbol S4



Resilient Base - (GE)

Includes base and latch straps.
For use with motors having 2 1/4" resilient rings.

NEMA 48 Frame, 2 1/4" Dia Rings

CAT. NO.	KIT NO.	LIST PRICE	SHELL LENGTH	FRAME SIZE	WEIGHT
AG109	161L113AAG1	\$31	5.16	32	5
AG110	161L113AAG2	\$31	5.41	33	5
AG111	161L113AAG3	\$31	5.79	35	5
AG112	161L113AAG4	\$31	6.22	36	5
AG113	161L113AAG5	\$31	6.62	37	5
AG114	161L113AAG6	\$31	7.22	38	5
AG115	161L113AAG9	\$31	7.75	39	5

NEMA 56 Frame, 2 1/4" Dia Rings

CAT. NO.	KIT NO.	LIST PRICE	SHELL LENGTH	FRAME SIZE	WEIGHT
AG125	161L113ADG1	\$31	5.41	33	5
AG127	161L113ADG3	\$31	6.22	36, 49	5
AG128	161L113ADG4	\$31	6.62	37, 46	5
AG129	161L113ADG5	\$31	7.22	38, 49	5
AG130	161L113ADG14	\$31	7.75	39, 49	5

6 1/2" Dia Fan & Blower Replacement Motors

CAT. NO.	KIT NO.	LIST PRICE	SHELL LENGTH	FRAME SIZE	WEIGHT
AG125	161L113ADG1	\$31	P243, P245	42	5
AG127	161L113ADG3	\$31	P244, P246, P180	49	5
AG128	161L113ADG4	\$31	P184, P185	46	5



Resilient Base - MEMC

Used to add a Resilient Base to models having Resilient Rings. Results in 3" shaft height. Kit includes: mounting base and 2 latch assemblies.

CAT. NO.	KIT NO.	LIST PRICE	RING TO RING DIMENSION	WEIGHT
A107	KIT 107-637	\$12	6.37"	2



Resilient Mounting Kit

Used to add a resilient base to models having hubs only. 3-1/2" shaft height. Kit includes: mounting base, 2 resilient rings, 2 latch assemblies, 2 end caps and a slinger.

CAT. NO.	KIT NO.	LIST PRICE	USED WITH CAT. NO.	BASE LENGTH	WEIGHT
A279	KIT 279	\$21	X500	8-5/8"	5
A280	KIT 280	\$21	X501, X511, X208	9-1/8"	5
A281	KIT 281	\$47	X507, X509	11-5/8"	5
A282	KIT 282	\$41	X503	10-5/8"	5
A283	KIT 283	\$41	X502, X207	9-5/8"	5
A308	KIT 308	\$44	X206	10-1/8"	5



Resilient Mount Kit

Fits 48 Frame motors with 2-1/2" diameter resilient rings. Available in 3 sizes to fit 9", 10" and 12" blowers.

CAT. NO.	KIT NO.	LIST PRICE	SIZE	WEIGHT
A240	KIT 240	\$40	9"	5
A241	KIT 241	\$60	12"	5
A242	KIT 242	\$49	10"	5

All Kits Listed on This Page are Stock

Accessory Kits - Multiplier Symbol S4

Split Mounting Rings

Used for adapting a 2-1/4" Resilient Mounting Ring to 2-1/2". Kit includes: 4 split rings.



CAT. NO.	KIT NO.	LIST PRICE	WEIGHT
A104	KIT 104	\$8	1

Resilient Ring Kit

Used to mount Resilient Rings onto Hubbed PSC Brackets. Kit includes: 2 rubber resilient rings and 4 split rings.



CAT. NO.	KIT NO.	LIST PRICE	WEIGHT	NOTES
A110	KIT 110	\$11	1	2-1/4" (48 frame)
A114	KIT 114	\$16	1	2-1/2" (56 frame)

Rubber Mounting Hardware

Used for mounting the resilient base to a resilient ring. Kit includes: 4 clamps, 2 screws, and 2 nuts.



CAT. NO.	KIT NO.	LIST PRICE	WEIGHT	NOTES
A112	KIT 112	\$10	1	56 Frame
A113	KIT 113	\$10	1	48 Frame
AG195	161L110AA1	\$10	1	2 1/2" dia; 30 or 40
A518	161L110AA4	\$10	1	2 1/2" dia; 40

48 Frame Lug Mounts Kits



A249
Single Strap,
Dual Slot
2" L, 1/4" & 3/4" W
\$35



A250
Double Strap,
Dual Slot
2" L, 1/4" & 3/4" W
\$35



A251
Double Strap,
Dual Slot
4" L, 1/4" & 3/4" W
\$35



A252
Single Strap,
Single Slot
2" L x 3/8" W
\$35



A253
Double Strap,
Single Slot
2" L x 3/8" W
\$35



A254
Double Wire,
Single Slot
2" L x 3/8" W
\$35

All Kits Listed on This Page are Stock

Accessory Kits - Multiplier Symbol S4

Length Adapter Kit



Used to convert Hubless motors to Resilient Ring mount. One adapter bracket can be mounted directly to original motor bracket and the other is mounted on the motor's thru-bolts and can be adjusted to desired length. Kit includes: 2 adapters, 2 resilient rings, 4 split rings, and the necessary nuts, screws, and washers.

CAT. NO.	KIT NO.	DESCRIPTION	LIST PRICE	WEIGHT
A111	KIT 111	Two Adapters	\$20	1

Rheem/Ruud Mounting Kit



Used to replace a Rheem/Ruud condenser fan motor where the original was held in place by four cables. Kit includes: prepunched plated steel plate, 4-8x32 nuts with washer fastened, 4-10x32 nuts with washers fastened and 4-1/4" sheet metal screws. Instructions included.

CAT. NO.	KIT NO.	LIST PRICE	WEIGHT
A259	Kit 259	\$25	2

Fedders Mounting Kit

Used in Fedders air conditioners.

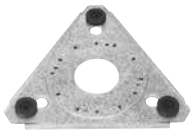

CAT. NO.	KIT NO.	LIST PRICE	WEIGHT
A277	KIT 277	\$25	2

Fedders Adapter Plate

Used to match Fedders rectangular mounting stud pattern on 5-5/8" motors.

CAT. NO.	KIT NO.	LIST PRICE	WEIGHT
A278	KIT 278	\$13	3

Capacitor Mounting Kit



Used for mounting a capacitor on the frame of a Permanent Split Capacitor motors. Kit includes: mounting strap, mounting screws, and terminal protection boot. (4 screws are included - 2#10 screws and 2#8 screws). **Fits 10mfd. and smaller capacitors only.**

CAT. NO.	KIT NO.	LIST PRICE	WEIGHT
A100	KIT 100	\$8	2

Capacitor with Mounting Kit

Kit includes 370 volt capacitor, mounting strap, mounting screws and terminal protection boot.

CAT. NO.	KIT NO.	SIZE	LIST PRICE	WEIGHT
A243	KIT 243	5.0 mfd	\$16	2
A244	KIT 244	7.5 mfd	\$19	2
A245	KIT 245	10.0 mfd	\$21	2

Oval Run Capacitors



CAT. NO.	KIT NO.	SIZE	LIST PRICE	WEIGHT
A965	111A271P113	208mfd/110V	\$12	2
A371	KIT 370-3	3mfd/370v	\$9	2
A372	KIT 370-4	4mfd/370v	\$9	2
A373	KIT 370-5	5mfd/370v	\$9	2
A375	KIT 370-7.5	7.5mfd/370v	\$11	2
A376	KIT 370-10	10mfd/370v	\$11	2
A378	KIT 370-15	15mfd/370v	\$19	2
A379	KIT 370-17.5	17.5mfd/370v	\$19	2
A380	KIT 370-20	20mfd/370v	\$21	2
A381	KIT 370-25	25mfd/370v	\$24	2
A382	KIT 370-30	30mfd/370v	\$27	2
A445	KIT 440-7.5	7.5mfd/440v	\$17	2
A446	KIT 440-10	10mfd/440v	\$19	2
A447	KIT 440-12.5	12.5mfd/440v	\$27	2
A448	KIT 440-15	15mfd/440v	\$27	2
A449	KIT 440-17.5	17.5mfd/440v	\$19	2

All Kits Listed on This Page are Stock

Accessory Kits - Multiplier Symbol S4

Capacitor Selection Guide for Stock PSC Motors

370 VOLT												440 VOLT					
3.0 mfd	4.0 mfd	5.0 mfd				7.5 mfd		10.0 mfd		15.0 mfd	17.5 mfd	20.0 mfd	25.0 mfd	30.0 mfd	7.5 mfd	10.0 mfd	
X411	X223	X001	X049	X081	X219	X430	X000	X294	X004	X453	X009	X433	X206	X462	X271	X454	X237
X427	X273	X003	X050	X082	X233	X440	X002	X413	X010	X458	X016	X447	X449	X448	X446	X241	
X429	X281	X006	X052	X083	X234	X441	X005	X415	X021	X1010	X023		X242		X405		
		X011	X056	X086	X236	X442	X013	X422	X033		X027						
		X012	X057	X087	X258	X443	X015	X424	X035		X036						
		X014	X058	X088	X262	X445	X018	X426	X038		X039						
		X017	X059	X089	X278	X463	X020	X450	X063		X085						
		X019	X060	X097	X287	X464	X022	X456	X068		X090						
		X033	X061	X200	X295	X466	X037	X457	X084		X099						
		X034	X062	X202	X297	X470	X071	X465	X096		X205						
		X040	X064	X204	X412	X477	X203		X098		X207						
		X041	X065	X209	X417		X213		X208		X218						
		X042	X066	X210	X418		X214		X211		X298						
		X043	X067	X212	X419		X222		X221		X444						
		X044	X069	X215	X420		X225		X400		X452						
		X045	X070	X216	X423		X231		X414		X455						
		X048	X080	X217	X428		X283		X416		X459						
									X451								

Shaft Adapter Sleeve



Used to increase the diameter of a shaft to a larger size. Available sizes include converting from a 1/2" dia. shaft with flat to a 5/8" dia. with key and from a 5/8" dia. with key to a 3/4" dia. with key. Kit includes adapter sleeve and key.

CAT. NO.	KIT NO.	TO CHANGE SHAFT	LIST PRICE	WEIGHT
A105	KIT 105	1/2" to 5/8"	\$8	3
A106	KIT 106	5/8" to 3/4"	\$11	3

Shaft Lock Device



Used as a pry point for prying the blade off. Instructions included.

CAT. NO.	KIT NO.	LIST PRICE	WEIGHT
A257	KIT 257	\$47	2

Blower Wheel Remover



Used to pull off corroded, rusted, stubborn blower wheels from 5/8" diameter shafts and smaller. Comes with complete instructions.

CAT. NO.	KIT NO.	LIST PRICE	WEIGHT
A256	KIT 256	\$148	2

Tapered Fork



Used for prying off pulleys, fan blades, etc., from any shaft 5/8" diameter or smaller. Long 16" handle gives good leverage. Instructions included.

CAT. NO.	KIT NO.	LIST PRICE	WEIGHT
A258	KIT 258	\$62	4

Toggle Switch



Start switches for single-phase open dripproof motors only in ratings one horsepower and smaller. Switch is mounted on the motor terminal box cover.

CAT. NO.	KIT NO.	LIST PRICE	WEIGHT	NO. OF POLES	FRAME SIZE
AG228	112A515AKG4	\$37	2	Single (SPST)	30
AG229	112A515ASG2	\$37	2	Single (SPST)	40

All Kits Listed on This Page are Stock

SB300 – Prices and Specifications are subject to change without notice.

Accessory Kits - Multiplier Symbol S4 (except as noted)

Brass Punch



Used for placing between your hammer and a motor's shaft or bearing. 3/4" diameter x 6" length.

CAT. NO.	KIT NO.	LIST PRICE	WEIGHT
A261	KIT 261	\$21	6

Motor Rainshield/Fan Canopy

Sizes to fit 1/2" or 5/8" diameter shafts. 6.88" diameter. Shield has 8 air vanes to provide air circulation for motor. For vertical shaft up applications. Rain shield mounts over shaft.

056 Type Model Numbers



CAT. NO.	KIT NO.	LIST PRICE	WEIGHT	SHAFT DIA.
A247	KIT 247	\$8	2	1/2"
A248	KIT 248	\$8	2	5/8"

5K Type Model Numbers

Includes clamp and black plastic cover.



CAT. NO.	KIT NO.	LIST PRICE	WEIGHT	WHERE USED
A549	52A101229AAG1	\$57	2	5.5" Dia. Motors, 1/2" shaft dia.

Drip Cover Kits

Mounts with two screws into the end bracket. Kit includes: drip cover, mounting screws, washers, and instructions. Contact Marathon Motors to determine compatibility with motor. For vertical shaft down applications.

Note: Kit 234, the mounting holes have a 4.80 bolt circle.

CAT. NO.	FRAME	KIT NO.	ENCLOSURE	LIST PRICE	WEIGHT
A234	48-184T("629")	KIT 234	ODP OR TEFC	\$24	2
AG234	48-56	161L528AAG1	5K MDLS ODP	\$24	2
A201	182T-184T	KIT 201	ODP	\$27	3
A662	182T-184T	KIT 175614	ODP (TTDW)	\$62	15
A197	182T-184T	KIT 197	TEFC (4-IN-1)	\$27	3
A202	213T-215T	KIT 202	ODP (TTDR)	\$31	5
A198	213T-215T	KIT 198	ODP (TTDW)	\$31	5
A199	213T-215T	KIT 199	TEFC (4-IN-1)	\$31	5
A311	254T-256T	KIT 311	ODP (TTDX) Rigid Base	\$31	8

Conduit Box Kit (56/140 Frame Explosion Proof Motors)

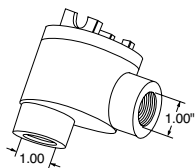

For installation on rolled steel 56/140 frame explosion proof motors. Lead exit holes are 1" dia. NPT.

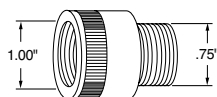

Lead Exit Reducers (56/140 Frame Explosion Proof Motors)

For reducing the lead exit from 1" to 3/4". Kit LDRDCR-M has an externally threaded 3/4" exit and internally threaded 1" exit.

CAT. NO.	KIT NO.	LIST PRICE	WEIGHT
A800	KIT 56 EXPR BOX	\$93	2

CAT. NO.	KIT NO.	LIST PRICE	WEIGHT
A803	KIT LDRDCR-M	\$17	2

Cast Iron Conduit Box Kits

Fits standard Blue Chip® motors. Threaded conduit box and gaskets.

CAT. NO.	FRAME	KIT NO.	LIST PRICE	WEIGHT
A720	182-215T	KIT 180/210CB	\$80	4
A722	254T-256T	KIT 250CB	\$132	12
A729	284T/TS-286T/TS	KIT 280CB	\$178	12
A730	324T/TS-326T/TS	KIT 320CB	\$198	28
A119	364T/TS-445T/TS	KIT 364-445CB	\$333	34

All Kits Listed on This Page are Stock

Accessory Kits - Multiplier Symbol S4

5K Motor Accessories



CAT. NO.	KIT NO.	DISCRIPTION	LIST PRICE	WEIGHT
A000	KIT 391-200-01	15' Single cable kit	\$38	3
A940	KIT 391-200-02	25' Single cable kit	\$50	4
A940	52D310833AAP001	30 Frame C-face PE Endshield	\$21	4
A941	52D311808ARP1	40 Frame C-face PE Endshield	\$39	4
A942	52D310814AAP1	30 Frame OPE Endshield	\$15	4
A945	115D964P1	Base Plate for 30 Frame	\$8	2
A946	115D964P2	Base Plate for 40 Frame	\$8	2
A947	115D963P1	Back Compartment Cover	\$8	2
A948	113A617AG001	OPE bearing 17 mm	\$9	3
A949	113A620AYP1	PE bearing 20 mm	\$21	2
A950	976B399AAP9	Run Capacitor 15mfd/370v	\$24	2
A951	976B399AAP12	Run Capacitor 22.5mfd/370v	\$28	2
A952	976B399AAP13	Run Capacitor 25mfd/370v	\$29	2
A953	976B399ABP6	Run Capacitor 40mfd/370v	\$39	2
A954	976B399ABP9	Run Capacitor 45mfd/370v	\$35	2
A955	976B399ABP10	Run Capacitor 50mfd/370v	\$29	2
A956	161L198AAG9	Switch for Single Speed Models	\$9	1
A957	161L198AAG10	Switch for Two Speed Models	\$17	2
A958	161L197ABG1	Start mech for Single Speed Models	\$4	1
A959	161L197ABG11	Start mech for Two Speed Models	\$8	1
A960A	3062.09	Start Capacitor 161-193mfd/110v	\$12	2
A961	111A271P111	Start Capacitor 40mfd/220v	\$12	2
A962	52D310822ACDP1	30 Frame Square Flange PE Endshield	\$20	4
A963	52D311819ABP1	40 Frame Square Flange PE Endshield	\$39	4
A964	52A103486G1	Voltage Changing Plug	\$3	2

Pump Motors Rainshield Kit

Designed for horizontally mounted pump motors to adhere to UL1081 standard. Includes screw and rain cover.



CAT. NO.	KIT NO.	WHERE USED	LIST PRICE	WEIGHT
AG697	161L210AAP1	5" & 5 1/2" Dia. Motors	\$57	1

All Kits Listed on This Page are Stock

Accessory Kits - Multiplier Symbol S4

Severe Duty - Upgrade to Cast Iron Fan Cover / Conduit Box

Fits standard Blue Chip® motors to achieve all cast iron construction.

Components include fan guard and threaded conduit box.

CAT. NO.	KIT NO.	LIST PRICE	FRAME	WEIGHT	WHERE USED
A715	KIT 140CB	\$110	143T-145T	4	TTTN
A718	KIT 180R	\$158	182T-184T	17	THFN, THFS, THTS, TTFC (Not XRI), TTFN, TTFS, TTTS
A721	KIT 210R	\$230	213T-215T	19	THFS, THTS, TTFC (Not XRI), TTFS, TTTS
A723	KIT 250RFPA	\$279	254T-256T	32	TTFPA, or THFPA
A724	KIT 250RFNA	\$279	254T-256T	34	TTFNA, TTFCA (Not XRI), THTNA, or THFNA
A725	KIT 250R	\$279	254T-256T	32	TTFC (Not XRI)
A726	KIT 280RFPA	\$388	284T-286T	34	TTFPA, TSTFPA, or TSHFPA
A727	KIT 280RFN	\$388	284T-286T	39	TTFN or TSTFN
A728	KIT 280R	\$388	284T-286T	39	TTFC (Not XRI) or TTFP
A731	KIT 280RFNA	\$388	284T-286T	32	TTFNA, TSTFNA, THFNA or TSHFNA
A733	KIT 320RFPA	\$411	324T-326T	55	TTFPA, TSTFPA, THFPA, or TSHFPA

Ball Bearing Conversion Kits

For conversion of Roller Bearing on Drive End to Ball Bearing (for Direct-coupled applications).

CONFIRM KIT SELECTION WITH CUSTOMER SERVICE/ENGINEERING

CAT. NO.	KIT NO.	LIST PRICE	FRAME	BEARING SIZE	ENCLOSURE	WEIGHT	WHERE USED (Models Containing)
A760	KIT 440BBFN	\$1,530	444T-445T	318	TEFC	160	TTFN, THFN
A761	KIT 449BBFS	\$1,592	447T-449T	319	TEFC	171	TTFS, THFS
A788	KIT 449BBFS-319	\$1,592	L447T-L449T	319	TEFC	174	TTFS
A787	KIT 449BBFS-322	\$1,592	447T-449T	322	TEFC	196	TTFS
A795	KIT L449BBFS-322	\$1,592	L447T-L449T	322	TEFC	190	TTFS

Roller Bearing Conversion Kits

For conversion of Ball Bearing on Drive End to Roller Bearing (for Belted Applications).

CONFIRM KIT SELECTION WITH CUSTOMER SERVICE/ENGINEERING

CAT. NO.	KIT NO.	LIST PRICE	FRAME	ENCLOSURE	WEIGHT	WHERE USED (Models Containing)
A755	KIT 360BRFSR-314	\$1,164	364T-365T	TEFC	14	TTFS, THFS
A756	KIT 400BRFS-316	\$1,164	404T-405T	TEFC	19	TTFS, THFS
A757	KIT 440BRFS-318	\$1,530	444T-445T	TEFC	32	TTFS, THFS
A759	KIT 440BRFN	\$1,530	444T-445T	TEFC	13	TTFN, THFN
A758	KIT 449BRFS	\$1,592	447T-449T	TEFC & TEBC	20	TTFS, THFS

Axial Blower Kits

For installation on Blue Chip XRI® Totally Enclosed and Severe Duty (excluding Explosion Proof).

CAT. NO.	KIT NO.	LIST PRICE	FRAME	WEIGHT	WHERE USED (Models Containing)
A692	KIT 21TEBC	\$1,606	213T-215T	104	TTFS
A691	KIT 25TEBCNA	\$1,755	254T-256T	158	TTFNA (Also fits 284/286T/TS TTFPA)
A701	KIT 28TEBCNA	\$2,066	284T/TS-286T/TS	103	TTFNA
A695	KIT 32TEBC	\$2,430	324T/TS-326T/TS	200	TTFS
A696	KIT 36TEBC	\$3,112	364T/TS-365T/TS	172	TTFS
A697	KIT 40TEBC	\$3,661	404T/TS-405T/TS	242	TTFS
A698	KIT 44TEBC-313	\$3,881	444TS-449TS	401	A 6313 bearing on opposite shaft end
A699	KIT 44TEBC-316	\$3,881	444T-449T	401	A 6316 bearing on opposite shaft end (excludes roller bearing)
A700	KIT 44TEBC-318	\$3,881	444T-449T	401	A 6318 bearing on opposite shaft end (excludes roller bearing)
A796	KIT L449TEBC	\$3,881	L447T-L449T	401	With L447/449 Frames

All Kits Listed on This Page are Stock

Accessory Kits - Multiplier Symbol E3

Encoder Kits and Accessories for Black Max®, Blue Max®, XRI®-SD and XRI®-841 motors

Installation of encoder kits on Blue Chip® XRI®-SD and XRI®-841 TEFC motors requires installation of A807 Stub Shaft Kit (see below)

ENCL.	FRAME	BRAND/ MODEL	PPR	CAT. NO.	KIT MO.	LIST PRICE	WEIGHT	NOTES		
TENV (5/8" bore)	56-286	Avtron HS25A	1024	A746	KIT HS25A1024-NV	\$1,064	4	Shaft Mount, 5-26 VDC, with 10 pin connector/mate		
			2048	A747	KIT HS25A2048-NV		4			
		Avtron HS35A	1024	A736	KIT HS35A1024-NV	\$1,446	4	Shaft Mount, 5-26 VDC, with 10 pin connector/mate		
			2048	A779A	KIT HS35A/B1024-NV		4	Shaft Mount, 5-26 VDC, with 10 pin connector/mate (REPLACES BEI A779)		
				A739	KIT HS35A2048-NV		4	Shaft Mount, 5-26 VDC, with 10 pin connector/mate		
				A780A	KIT HS35A/B2048-NV		4	Shaft Mount, 5-26 VDC, with 10 pin connector/mate (REPLACES BEI A780)		
		Avtron HS35M	1024	A742	KIT HS35M1024	\$1,674	4	Shaft Mount, 5-24 VDC, with EPIC connector/mate		
		Avtron M3	1024	A753	KIT M31024-NV	\$2,800	10	Shaft Mount, 5-24 VDC, with EPIC connector/mate		
		Avtron AV56	1024	A793	KIT M561024-NV	\$2,283	5	Modular Mount, 5-24 VDC, with EPIC connector/mate, Double C-Face		
		BEI HS35	1024	A779	KIT HS35B1024-NV	\$1,446	3	Shaft Mount, 5-28 VDC, with 10 pin connector/mate (To Be Discontinued)		
			2048	A780	KIT HS35B2048-NV		3			
		Dynapar HS20	1024	A687	KIT HS201024-NV	\$672	3	Shaft Mount, 5-26 VDC, with 10 pin connector/mate		
		Dynapar HS35R	1024	A772	KIT HS351024-NV	\$1,446	3	Shaft Mount, 5-26 VDC, with 10 pin connector/mate		
			2048	A776	KIT HS352048-NV		3			
		EPC 260	2048	A686	KIT EPC260 2048	\$672	3	Shaft Mount, 5-16 VDC, with M12 Connector (To Be Discontinued)		
NorthStar HSD35	1024	A711	KIT HSD351024-NV	\$1,562	4	Shaft Mount, 5-26 VDC, with EPIC connector/mate				
	512	A785	KIT LKSR512	\$2,283	5	Modular Mount, 5-15 VDC, with EPIC connector/mate				
NorthStar ST56	1024	A763	KIT LKSR02	\$2,283	5	Modular Mount, 5-15 VDC, with EPIC connector/mate				
	1024	A786	KIT LKSR-CFACE	\$2,510	5	Modular Mount, 5-15 VDC, with EPIC connector/mate, Double C-Face				
TEFC (1" bore)	182-449	Avtron HS35A	1024	A737	KIT HS35A1024-FC	\$1,446	4	Shaft Mount, 5-26 VDC, with 10 pin connector/mate		
			2048	A783A	KIT HS35A/B1024-FC		4	Shaft Mount, 5-26 VDC, with 10 pin connector/mate (REPLACE BEI A783)		
				A740	KIT HS35A2048-FC		4	Shaft Mount, 5-26 VDC, with 10 pin connector/mate		
				A784A	KIT HS35A/B2048-FC		4	Shaft Mount, 5-26 VDC, with 10 pin connector/mate (REPLACE BEI A784)		
		Avtron HS35M	1024	A742	KIT HS35M1024	\$1,674	4	Shaft Mount, 5-24 VDC, with EPIC connector/mate		
		Avtron M3	1024	A754	KIT M31024-FC	\$2,800	10	Shaft Mount, 5-24 VDC, with EPIC connector/mate		
		BEI HS35	1024	A783	KIT HS35B1024-FC	\$1,446	3	Shaft Mount, 5-28 VDC, with 10 pin connector/mate (To Be Discontinued)		
			2048	A784	KIT HS35B2048-FC		3			
		Dynapar HS35R	1024	A774	KIT HS351024-FC	\$1,446	3	Shaft Mount, 5-26 VDC, with 10 pin connector/mate		
			2048	A777	KIT HS352048-FC		3			
		NorthStar HSD35	1024	A712	KIT HSD351024-FC	\$1,562	4	Shaft Mount, 5-26 VDC, with EPIC connector/mate		
		Avtron HS35A	1024	A738	KIT HS35A1024-BC	\$1,446	3	Shaft Mount, 5-26 VDC		
		Avtron AV56	1024	A794	KIT M561024-BC	\$2,283	4	Shaft Mount, 5-24 VDC		
		BEI HS35	1024	A781	KIT HS35B1024-BC	\$1,446	3	Shaft Mount, 5-28 VDC, (To Be Discontinued)		
			2048	A782	KIT HS35B2048-BC		3			
Dynapar HSD38	1024	A775	KIT HS351024-BC	\$1,446	3	Shaft Mount, 5-26 VDC				
	2048	A778	KIT HS352048-BC		3					
NorthStar ST56	1024	A764	KIT LKSR03	\$2,283	5	Modular Mount, 5-15 VDC				
Turck A02H	1024	A668	KIT A02H1024-BC LED	\$1,624	4	Shaft Mount, 5-30VDC, bulkhead (A801 not required), LED cordset (3m)				
	2048	A669	KIT A02H2048-BC LED		4					
ALL		A801	KIT ENCB0X	\$152	2	Encoder Conduit Box (required for all TEFC encoders except Turck A02H)				
TENV BRAKE- MOTORS	143-256	Avtron AV56	1024	A748	KIT M561024BRK-140	\$2,283	4	Fits Blue Max® Brakemotors (Y986, Y987)		
				A749	KIT M561024BRK-182		4	Fits Blue Max® Brakemotors (Y988)		
		Avtron AV85	1024	A750	KIT M851024BRK-184	\$3,080	8	Fits Blue Max® Brakemotors (Y989)		
				A751	KIT M851024BRK-210		8	Fits Blue Max® Brakemotors (Y990, Y991)		
				A752	KIT M851024BRK-250		8	Fits Blue Max® Brakemotors (Y992, Y993)		
		NorthStar ST56	1024	A786	KIT LKSR-CFACE	\$2,510	5	Fits Blue Max® Brakemotors (Y986, Y987)		
				A789	KIT SL561024-182NV		5	Fits Blue Max® Brakemotors (Y988)		
				A790	KIT SL851024-184NV		8	Fits Blue Max® Brakemotors (Y989)		
		NorthStar ST85	1024	A791	KIT SL851024-210NV	\$3,080	8	Fits Blue Max® Brakemotors (Y990, Y991)		
				A792	KIT SL851024-250NV		8	Fits Blue Max® Brakemotors (Y992, Y993)		
		CABLE KITS	56-449		N/A	A688-10	KIT A688-10	\$279	3	10' cable and pre-wired 10-pin connector for all 10 pin (MS) connectors
					N/A	A688-20	KIT A688-20	\$393	3	20' cable and pre-wired 10-pin connector for all 10 pin (MS) connectors
					N/A	A688-25	KIT A688-25	\$446	4	25' cable and pre-wired 10-pin connector for all 10 pin (MS) connectors
					N/A	A688-30	KIT A688-30	\$502	4	30' cable and pre-wired 10-pin connector for all 10 pin (MS) connectors
					N/A	A688-50	KIT A688-50	\$725	5	50' cable and pre-wired 10-pin connector for all 10 pin (MS) connectors
	N/A			A688-60	KIT A688-60	\$836	5	60' cable and pre-wired 10-pin connector for all 10 pin (MS) connectors		
	N/A			A688-100	KIT A688-100	\$1,280	10	100' cable and pre-wired 10-pin connector for all 10 pin (MS) connectors		
	N/A			A690-15	KIT A690-15	\$231	3	15 feet bulk cable, for use with NorthStar encoders		

Encoder Stub Shaft Kit

Fits XRI® Severe Duty or XRI® IEEE-841 motors to allow the addition of 1" bore hollow shaft encoders on opposite drive end of motor.

CAT. NO.	KIT NO.	LIST PRICE	FRAME	WEIGHT	WHERE USED
A807	KIT STUBSHAFT 1IN	\$168	182T-449T/TS	3	FAN COOLED SEVERE DUTY AND IEEE-841

All Kits Listed on This Page are Stock

Accessory Kits - Multiplier Symbol E3

Shaft Grounding Kits

Shaft Grounding:



Shaft grounding is recommended (NEMA MG1 31.4.4.3) as an effective means of bearing protection for motors operated from inverter power. One grounding device is adequate to bleed down inverter-sourced shaft voltages, thereby protecting both bearings for motors as large as 6085 frame.

SGR Kit:

Kit includes grounding ring, adhesive mounting hardware and instructions (for domestic products only).

SGR Universal Kit:

Kit includes grounding ring, all mounting hardware needed to mount to any standard drive end bracket and instructions.

Shaft ground rings fit these NEMA shaft extension frames listed below, they are designed to mount on the shaft end. For larger frames, please contact Marathon Motors.

SGR Kit

FRAME	SGR KIT NO.	SGR CAT. NO.	LIST PRICE	WEIGHT
48	KIT SGR-11.2	A500-5	\$218	2
56	KIT SGR-14.4	A500-8	\$218	1
143-145T	KIT SGR-20.7	A500-14	\$232	2
182-184T	KIT SGR-27.1	A500-20	\$252	1
213-215T	KIT SGR-33.4	A500-26	\$284	1
254-256T	KIT SGR-39.8	A500-32	\$351	1
284-286T	KIT SGR-46.1	A500-38	\$419	1
284-286TS	KIT SGR-39.8	A500-32	\$351	1
324-326T	KIT SGR-52.5	A500-44	\$485	1
324-326TS	KIT SGR-46.1	A500-38	\$419	1
364-365T	KIT SGR-58.8	A500-50	\$551	1
364-365TS	KIT SGR-46.1	A500-38	\$419	1
404-405T	KIT SGR-71.5	A500-62	\$815	1
404-405TS	KIT SGR-52.5	A500-44	\$485	1
444-445T	KIT SGR-84.2	A500-74	\$1,168	1
444-445TS	KIT SGR-58.8	A500-50	\$551	1
447/449T	KIT SGR-84.2	A500-74	\$1,168	1
447/449TS	KIT SGR-58.8	A500-50	\$551	1
5000LS	KIT SGR-71.5	A500-62	\$815	1

SGR Universal Kit

SGR KIT NO.	SGR UKIT CAT. NO.	LIST PRICE	WEIGHT
---	---	---	---
KIT SGR-0.625-UK	A499-1	\$338	5
KIT SGR-0.875-UK	A499-2	\$365	5
KIT SGR-1.125-UK	A499-3	\$391	5
KIT SGR-1.375-UK	A499-4	\$417	5
KIT SGR-1.625-UK	A499-5	\$522	5
KIT SGR-1.875-UK	A499-6	\$574	5
KIT SGR-1.625-UK	A499-5	\$522	5
KIT SGR-2.125-UK	A499-7	\$653	7
KIT SGR-1.875-UK	A499-6	\$574	5
KIT SGR-2.375-UK	A499-8	\$706	7
KIT SGR-1.875-UK	A499-6	\$574	5
KIT SGR-2.875-UK	A499-9	\$915	7
KIT SGR-2.125-UK	A499-7	\$653	7
KIT SGR-3.375-UK	A499-10	\$1,230	7
KIT SGR-2.375-UK	A499-8	\$706	7
KIT SGR-3.375-UK	A499-10	\$1,230	7
KIT SGR-2.375-UK	A499-8	\$706	7
---	---	---	---

Conductive Epoxy:

Epoxy comes in two 7g syringes, 14g (0.35 oz). This two part epoxy offers high electrical conductivity and strong conductive bonding. Use in place of traditional end bracket drilling.

CAT. NO.	KIT NO.	LIST PRICE	WEIGHT
A496	EP2400	\$511	2

Replacement ground brush mounting hardware and brushes

CAT. NO.	KIT NO.	LIST PRICE	WEIGHT	COMMENTS
A103	KIT 103	\$349	1	Drive end mount
A116	KIT 116	\$504	1	Non-drive end mount
A109	KIT 109	\$55	1	Replacement Brush

▲WARNING: Grounding devices may not be installed on motors used in Division 1 or Division 2 hazardous locations.

All Kits Listed on This Page are Stock

Accessory Kits - Multiplier Symbol S4

Transition Bases

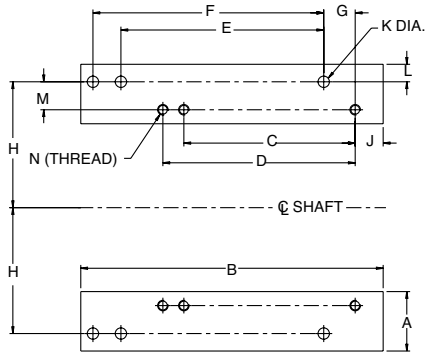

Application:

Convert "T" frame ratings to "U" frame based dimensions and shaft heights. Shaft dimensions may vary from actual "U" frame specifications.

Dimensions = Inches

CAT. NO.	KIT NO.	CONVERTS		A	B	HGT	C	D	E	F	G	H	J	K	L	M	N (THREAD)	APP. WGHT.	LIST PRICE
		FROM	TO																
1814T	KIT 180U	143/5T	182/4	2 1/4	7 1/2	1	4	5	4 1/2	5 1/2	1/2	3 3/4	1	7/16	1/2	1	5/16-18	2	\$147
2118T	KIT 210U	182/4T	213/5	1 3/4	9 1/2	3/4	4 1/2	5 1/2	5 1/2	7	1	4 1/4	1	7/16	7/16	1/2	3/8-16	3	\$186
25U21T	KIT 250U	213/5T	254/6U	2 7/16	12 3/4	1	5 1/2	7	8 1/4	10	1 1/8	5	1	9/16	5/8	3/4	3/8-16	5	\$186
28U25T	KIT 280U	254/6T	284/6U	2 3/4	14 1/4	3/4	8 1/4	10	9 1/2	11	1 3/8	5 1/2	1 1/4	9/16	15/16	1/2	1/2-13	8	\$186
32U28T	KIT 320U	284/6T	324/6U	3 1/4	15 3/4	1	9 1/2	11	10 1/2	12	1 1/2	6 1/4	1 1/2	11/16	15/16	3/4	1/2-13	10	\$220
36U32T	KIT 360U	324/6T	364/5U	3 11/16	16 1/2	1	10 1/2	12	11 1/4	12 1/4	1 3/4	7	1 3/4	11/16	1 3/16	3/4	5/8-11	13	\$260
40U36T	KIT 400U	364/5T	404/5U	4 1/4	18 5/8	1	11 1/4	12 1/4	12 1/4	13 3/4	2	8	2	13/16	1 1/4	1	5/8-11	22	\$333
44U40T	KIT 440U	404/5T	444/5U	4 1/4	21 5/8	1	12 1/4	13 3/4	14 1/2	16 1/2	2 1/4	9	2	13/16	1 1/4	1	3/4-10	24	\$333

Adjustable Motor Bases (Slide Bases)

Series F

Series G & H

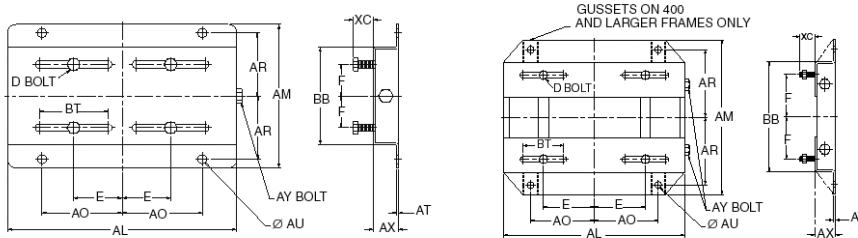

Application:

Used to adjust tension during motor installation. Made with heavy duty steel construction with single screw adjustment for 143T-215T Frame and double screw adjustment for 254T Frame and larger.

Dimensions = Inches

SERIES	FRAME	CAT. NO.	KIT NO.	AL	AM	AX	BB	E	F	AO	AR	AU	BT	AT	XC	D BOLT	AY BOLT	WGHT. LBS.	LIST PRICE
F	143	143A	KIT 143SB	10 1/2	7 1/2	1 1/8	5 1/2	2 3/4	2	3 3/4	3 3/8	3/8	3	0.119	13/16	5/16 x1	3/8x4	5	\$90
F	145	145A	KIT 145SB	10 1/2	8 1/2	1 1/8	6 1/2	2 3/4	2 1/2	3 3/4	3 7/8	3/8	3	0.119	13/16	5/16x1	3/8x4	6	\$100
F	182	182A	KIT 182SB	12 3/4	9 1/2	1 1/2	6 1/2	3 3/4	2 1/4	4 1/2	4 1/4	1/2	3	0.134	1 1/2	3/8x1 3/4	1/2x6	9	\$120
F	184	184A	KIT 184SB	12 3/4	10 1/2	1 1/2	7 1/2	3 3/4	2 3/4	4 1/2	4 3/4	1/2	3	0.134	1 1/2	3/8s 1 3/4	1/2x6	9	\$120
F	213	213A	KIT 213SB	15	11	1 3/4	7 1/2	4 1/4	2 3/4	5 1/4	4 3/4	1/2	3 1/2	0.164	1 1/2	3/8x1 3/4	1/2x6	13	\$193
F	215	215A	KIT 215SB	15	12 1/2	1 3/4	9	4 1/4	3 1/2	5 1/4	5 1/2	1/2	3 1/2	0.164	1 1/2	3/8x1 3/4	1/2x6	15	\$228
G	254	254B2	KIT 254SB	17 3/4	15 1/8	2	10 3/4	5	4 1/8	6 1/4	6 5/8	5/8	4	3/16	1 7/16	1/2x1 3/4	5/8x6	17	\$377
G	256	256B2	KIT 256SB	17 3/4	16 7/8	2	12 1/2	5	5	6 1/4	7 1/2	5/8	4	3/16	1 7/16	1/2x1 3/4	5/8x6	18	\$493
G	284	284B2	KIT 284SB	19 3/4	16 7/8	2	12 1/2	5 1/2	4 3/4	7	7 1/2	5/8	4 1/2	3/16	2 1/2	1/2x2	5/8x6	21	\$996
G	286	286B2	KIT 286SB	19 3/4	18 3/8	2	14	5 1/2	5 1/2	7	8 1/4	5/8	4 1/2	3/16	2 1/2	1/2x2	5/8x6	22	\$1,192
G	324	324B2	KIT 324SB	22 3/4	19 1/4	2 1/2	14	6 1/4	5 1/4	8	8 1/2	3/4	5 1/4	3/16	2 3/16	5/8x2 1/2	3/4x9	31	\$1,192
G	326	326B2	KIT 326SB	22 3/4	20 3/4	2 1/2	15 1/2	6 1/4	6	8	9 1/4	3/4	5 1/4	3/16	2 3/16	5/8x2 1/2	3/4x9	32	\$1,192
G	364	364B2	KIT 364SB	25 1/2	20 1/2	2 1/2	15 1/2	7	5 5/8	9	9 1/8	3/4	6	1/4	2 1/16	5/8x2 1/2	3/4x9	44	\$1,192
G	365	365B2	KIT 365SB	25 1/2	21 1/2	2 1/2	16 1/2	7	6 1/8	9	9 5/8	3/4	6	1/4	2 1/16	5/8x2 1/2	3/4x9	45	\$1,192
H	404	404B2	KIT 404SB	28 3/4	22 3/8	3	16 1/2	8	6 1/8	10	9 7/8	7/8	7	1/4	2 1/2	3/4x3	3/4x11	60	\$1,192
H	405	405B2	KIT 405SB	28 3/4	23 7/8	3	18	8	6 7/8	10	10 5/8	7/8	7	1/4	2 1/2	3/4x3	3/4x11	61	\$1,192
H	444	444B2	KIT 444SB	31 1/4	24 5/8	3	19 1/4	9	7 1/4	11	11	7/8	7 1/2	1/4	2 1/2	3/4x3	3/4x11	67	\$1,192
H	445	445B2	KIT 445SB	31 1/4	26 5/8	3	21 1/4	9	8 1/4	11	12	7/8	7 1/2	1/4	2 1/2	3/4x3	3/4x11	69	\$1,192
H	447	447B2	KIT 447SB	31 1/4	30 1/8	3	24 3/4	9	10	11	13 3/4	7/8	7 1/2	5/16	3	3/4x3 1/2	3/4x11	92	\$1,192
H	449	449B2	KIT 449SB	31 1/4	35 1/8	3	29 3/4	9	12 1/2	11	16 1/4	7/8	7 1/2	5/16	3	3/4x3 1/2	3/4x11	95	\$1,192

All Kits Listed on This Page are Stock

SB300 - Prices and Specifications are subject to change without notice.

New & Improved - www.marathonelectric.com

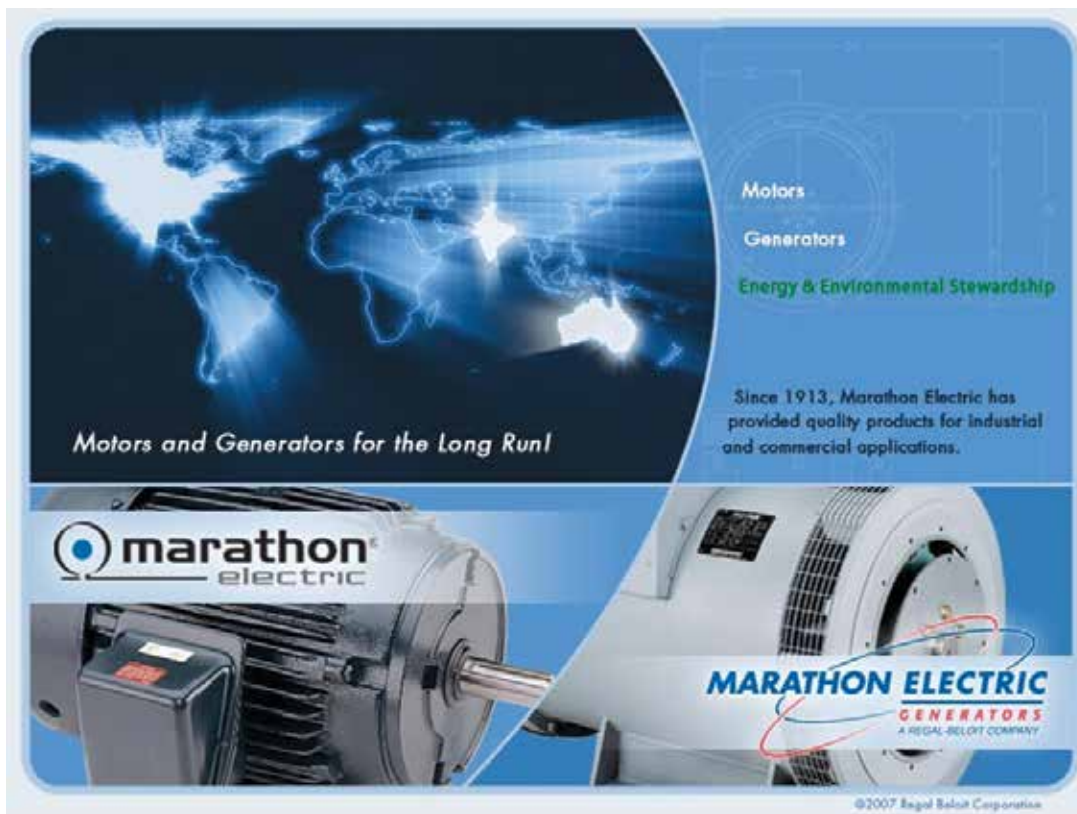

As previously announced the new and improved Marathon Motors website is "live." The new website is a great resource for selecting products, providing technical data, catalogs, brochures, outline drawings, ME-Business eCommerce site and much, much more.

Not only has the look changed, the features have as well. A few of these include: competitive cross-reference, distributor search, motor date code chart and instructions on how to read a model number. A competitive cross reference allows you to find the equivalent Marathon motor to a number of other brands.

The new website is very user-friendly. Simply log onto www.marathonelectric.com. Click on the 'motors' link. If you know the model or catalog number, simply enter it in the search tool at the top of the page. Other functions are listed below.

Products

- AC Motors Search
- DC Motors Search
- Competitive Cross Reference

ME Business

- Log-In Screen

Contact Us

- Home Office Information

Service & Support

- Service Locations
- Distributor Search
- Service Parts
- Standard Warranty Policy
- Frequently Asked Questions
- Motor Date Codes
- How to Read a Model Number
- Warranty Forms

Literature

- Catalogs & Brochures
- Installation, Operation, & Maintenance Manuals
- Terms & Conditions

Log on to the new www.marathonelectric.com today!

SyMAX® Permanent Magnet AC Motors

The Most Sustainable Motor Available Today



SyMAX® Industrial – Cast Iron Severe Duty
NEMA 182-286T – IEC 132-180



SyMAX-i® with Intellidrive™



Looking For The Next Level Of Efficiency?

SyMAX® PMAC motors deliver impressive energy savings by the elimination of rotor conductor losses, optimized fan design, precision-wound stator and variable speed operation. These Ultra Efficient™ motors surpass European IE4 efficiency levels...5 years ahead of scheduled implementation, achieving efficiencies 25-35% over NEMA Premium™! The energy savings alone often pays for the motor in as little as two years. Additionally, the SyMAX® efficiency profile remains flatter than an equivalent induction motor as the speed and load declines, allowing the user to capture even greater energy savings when operated at the application's ideal speed.

Electric motors consume an estimated 25% of all electricity and up to 65% of all electrical energy consumed by industrials. Energy costs are projected to continue to increase in the future. A "mere" 1% gain in energy efficiency would reduce carbon emissions by an estimated 80 million tons per year. SyMAX® motors provide a very cost-effective way to reduce our "carbon footprint" and assure a cleaner environment.

SyMAX® motors provide the highest level of reliability and longevity, coupled with low maintenance costs, due to their low operating temperature, high ingress protection levels and ultra-precision balancing techniques.

Specials Are Our Specialty

143-449T, IP56,
Hazardous Duty™
Class I and II,
Groups C, D, F & G



6805 DPFV
Cast Iron, Force Ventilated, F2



Roller Table Motor - Round
Annular fin design, Cast Iron,
FF Flange, F4



Roller Table Motor - Footed
Annular fin design, Cast Iron, F4



5007 - 5010 Frame
All New designs



TEFC FIRE PUMP
3Hp to 450Hp,
Red Paint



Shaker Duty,
Hazardous Duty™
210-360 Frame, Round,
Dual Flange



280 IEC TEBC
Blower Cooled, Ground
Brush, F3



440TCZ TEFC
Cast Iron,
Tapered ODE Shaft, F2



Specials Are Our Specialty

320TCZ TEFC
Special Shaft, C-Face



Ground Brush
Opposite Drive End

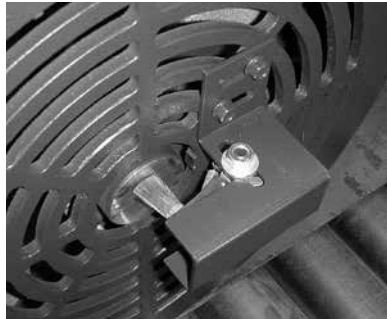

AEGIS® Shaft Grounding
Ring
Drive End



320 TCZ TEBC
Blower Cooled, Special
ODE shaft, C-Face



320 TZ TENV
Non Ventilated, Special
ODE Shaft, Encoder



5007-5013 Vertical Frames
TENV and TEFC



400TC TEBC
Blower Cooled, C-Face, F3



Marathon's "IntelliBrake"
Stearns & Dings Brakes
with Imbedded Encoder



440TD TEFC Round
Cast Iron, Round, D-Flange



Index

Catalog Number/Model Number

CAT. NO.	MODEL NO.	STOCK	PAGE NO.	CAT. NO.	MODEL NO.	STOCK	PAGE NO.	CAT. NO.	MODEL NO.	STOCK	PAGE NO.	CAT. NO.	MODEL NO.	STOCK	PAGE NO.
25U21T	KIT 250U	✓	223	3727	SEE X411	184	4706	SEE HG700	✓	170	A112	KIT 112	✓	215	
28U25T	KIT 280U	✓	223	3728	SEE X412	162	4707	SEE 4757	✓	170	A112-(GE)	SEE AG112	✓	214	
32U28T	KIT 320U	✓	223	3729	SEE X413	162	4708	SEE D162	✓	170	A113	KIT 113	✓	215	
36U32T	KIT 360U	✓	223	3730	SEE X414	162	4722	5KH39QN5558T	✓	178,185	A113-(GE)	SEE AG113	✓	214	
40U36T	KIT 400U	✓	223	3732	SEE X412	162	4725	5KH32DN5587X	✓	119	A114	KIT 114	✓	215	
44U40T	KIT 440U	✓	223	3733	SEE X415	162	4730	5KH39QN9725T	✓	174	A114-(GE)	SEE AG114	✓	214	
143A	KIT 143SB	✓	223	3736	SEE X456	162	4731	5KH39QN9696X	✓	174	A115-(GE)	SEE AG115	✓	214	
145A	KIT 145SB	✓	223	3737	SEE X457	162	4732	5KH39QN9702T	✓	174	A116	KIT 116	✓	222	
182A	KIT 182SB	✓	223	3738	SEE X458	162	4733	5KH39DNA533T	✓	174	A119	KIT 364-445CB	✓	218	
184A	KIT 184SB	✓	223	3739	SEE X459	162	4734	5KH32HNA532T	✓	174	A125-(GE)	SEE AG125	✓	214	
213A	KIT 213SB	✓	223	3746	SEE X452	162	4735	5KH33JNA534T	✓	174	A127-(GE)	SEE AG127	✓	214	
215A	KIT 215SB	✓	223	3783	SEE X034	167	4738	5KH39QN9703T	✓	174	A128-(GE)	SEE AG128	✓	214	
254B2	KIT 254SB	✓	223	3785	SEE X035	167	4739	5KH39QN9704T	✓	174	A129-(GE)	SEE AG129	✓	214	
256B2	KIT 256SB	✓	223	3787	SEE X036	167	4757	5KH39QN9636T	✓	170	A130-(GE)	SEE AG130	✓	214	
284B2	KIT 284SB	✓	223	3945	SEE X445	163	4758	5KH39QN9698T	✓	170	A157	KIT VRT87BRK	✓	213	
286B2	KIT 286SB	✓	223	3946	SEE X446	163	4759	5KH39QN9697T	✓	170	A160	KIT 180TCD-WD	✓	209	
324B2	KIT 324SB	✓	223	4050	SEE 4370	170	4773	SEE O005	✓	175	A161	KIT 210TCD-WD	✓	209	
326B2	KIT 326SB	✓	223	4304	5KH39QN5543	✓	169	4774	5KH33GN5014U	✓	175	A162	KIT 250TCD2-WD	✓	209
364B2	KIT 364SB	✓	223	4305	5KH39QN5511X	✓	169	4776	5KH39QN5539T	✓	26	A163	KIT 250TCD-WD	✓	209
365B2	KIT 365SB	✓	223	4306	5KH39QN5537X	✓	169	4777	SEE O701	✓	175	A164	KIT 280TCD2-WD	✓	209
404B2	KIT 404SB	✓	223	4308	SEE HG700	170	4778	5KH39QN9639T	✓	26	A165	KIT 280TCD-WD	✓	209	
405B2	KIT 405SB	✓	223	4309	5KH39QN9514X	✓	170	4779	SEE O100	✓	175	A166	KIT 320TCD2-WD	✓	209
444B2	KIT 444SB	✓	223	4310	5KH39QN5508X	26	4781	5KC37HN3898U	✓	175	A167	KIT 320TCD-WD	✓	209	
445B2	KIT 445SB	✓	223	4311	5KH39QN5529X	✓	26	4782	SEE O600	✓	175	A168	KIT 360TCD2-WD	✓	209
447B2	KIT 447SB	✓	223	4314	SEE D107	169	4784	SEE O601	✓	175	A169	KIT 360TCD-WD	✓	209	
449B2	KIT 449SB	✓	223	4319	5KH39QN9429T	✓	169	4786	SEE O002	✓	175	A170	KIT 180TCF-WD	✓	210
1814T	KIT 180U	✓	223	4322	5KH39QN9548	✓	169	4787	SEE O003	✓	175	A171	KIT 210TCF-WD	✓	210
2118T	KIT 210U	✓	223	4338	5KH39QN9541T	✓	170	4788	5KC37EN3900U	✓	175	A172	KIT 250TCF2-WD	✓	210
3001	SEE X230	177,182	4349	5KH39QN9537X	✓	21	4798	5KH35FN153T	✓	169	A173	KIT 250TCF-WD	✓	210	
3028	SEE X081	160	4350	5KH39QN5538X	✓	169	4805	5KH32GNB811X	✓	119	A174	KIT 280TCF2-WD	✓	210	
3037	SEE X090	161	4351	5KH39QN9542	✓	23	9029	5KC49NN0221X	✓	23	A175	KIT 280TCF-WD	✓	210	
3048	SEE X085	161	4352	SEE S102	25	9030	5KC49NN0222X	✓	193	A176	KIT 320TCF2-WD	✓	210		
3050	SEE X209	166,184	4354	5KH39QN9538	✓	21	9031	5KC49MN2043Y	✓	21,187	A177	KIT 320TCF-WD	✓	210	
3070	SEE X200	185	4355	5KH39QN5525	✓	169	9032	5KC49MN2049Y	✓	21,187,193	A178	KIT 360TCF2-WD	✓	210	
3082	SEE X236	162,181,184	4359	5KH39QN5523	✓	25	9033	5KC49NN2050Y	✓	21,187	A179	KIT 360TCF-WD	✓	210	
3084	SEE X441	161	4360	5KH39QN5548	✓	169	9034	5KC49NN2044Y	✓	23	A181	KIT 143TCTN-841	✓	211	
3085	SEE X442	161	4362	5KH39QN9686X	✓	21	9035	5KCR48TN2650Y	✓	23,187	A182	KIT 180TCFS-841	✓	211	
3086	SEE X443	161	4363	5KH39QN5526X	✓	169	9036	5KCR48UN2653Y	✓	22,188	A183	KIT 210TCFS-841	✓	211	
3132	SEE X203	181	4364	5KH39QN5541X	✓	25	9038B	5KCR49ZN2722Y	✓	23,188	A184	KIT 250TCFNA-841	✓	211	
3155	SEE X278	161,184	4368	5KH39QN9397	23	9040	5KCR48UN2654Y	✓	187	A185	KIT 280TCFN-841	✓	211		
3204	SEE X450	162	4369	5KH39QN5508	✓	26	A000	KIT 391-200-01	✓	219	A186	KIT 280TCFNA-841	✓	211	
3205	SEE X451	162	4370	5KH39QN9682	✓	170	A001	KIT 391-200-02	✓	219	A187	KIT 320TCFS-841	✓	211	
3206	SEE X302	178	4371	5KH39QN5529	✓	26	A020-A	---	✓	152	A188	KIT 360TCFSR-841	✓	211	
3208	SEE X303	178	4372	5KH39QN9546	✓	23	A020-AA	---	✓	152	A189	KIT 360TSCFSR-841	✓	211	
3212	SEE X304	178	4373	5KH39QN9543	✓	23	A020-B	---	✓	152	A190	KIT 400TCFS-841	✓	211	
3220	SEE X216	161,184	4376	5KH39QN9547	23	A020-BB	---	✓	152	A191	KIT 400TSCFS-841	✓	211		
3221	SEE X297	161,184	4377	5KH39QN5524	✓	26	A020-C	---	✓	152	A192	KIT 440TCFS-841	✓	211	
3230	SEE X416	162	4380	5KH39QN9681X	✓	23	A020-CC	---	✓	152	A193	KIT 440TSCFS-841	✓	211	
3280	SEE X037	167	4381	5KH39QN5528X	✓	26	A020-D	---	✓	152	A194	KIT 440TCFN-841	✓	211	
3288	SEE X405	181	4383	5KH39QN9513X	✓	170	A020-E	---	✓	152	A195	KIT 440TSCFN-841	✓	211	
3290	SEE X039	167	4386	SEE S120	26	A030-A	---	✓	152	A195-(GE)	SEE AG195	✓	215		
3328	SEE X213	160	4387	5KH39QN9684	✓	26	A030-AA	---	✓	152	A197	KIT 197	✓	218	
3329	SEE X214	161	4389	5KH39QN9548X	✓	169	A030-B	---	✓	152	A198	KIT 198	✓	218	
3330	SEE X221	161	4390	5KH39QNA039	✓	170	A030-BB	---	✓	152	A199	KIT 199	✓	218	
3331	SEE X298	161	4392	5KH39QN9405X	✓	170	A030-C	---	✓	152	A201	KIT 201	✓	218	
3463	SEE X077	180	4393	5KH39QN9544X	✓	170	A030-CC	---	✓	152	A202	KIT 202	✓	218	
3464	SEE X073	180	4396	5KH39QN9683	✓	169	A030-D	---	✓	152	A204	KIT 210TCFL	✓	210	
3465	SEE X072	179	4399	5KH39QN9551X	✓	169	A030-E	---	✓	152	A206	KIT 210TCFS	✓	210	
3466	SEE X074	180	4404	5KH39QN5550X	✓	178,185	A100	KIT 100	✓	216	A209	KIT 250TCFL	✓	210	
3467	SEE X075	180	4406	5KH32FN5586X	✓	119	A103	KIT 103	✓	222	A212-(GE)	SEE AG212	✓	209	
3468	SEE X076	179	4412	5KH39QN9550X	✓	169	A104	KIT 104	✓	215	A214	KIT 320TCFS	✓	210	
3583	SEE X000	166	4422	5KH39QN9687	✓	26	A105	KIT 105	✓	217	A215-(GE)	SEE AG215	✓	210	
3584	SEE X001	166	4602	5KH39QN9518X	✓	26	A106	KIT 106	✓	217	A216	KIT 360TSCDS	✓	209	
3585	SEE X002	166	4680	5KH32FN3120T	✓	169	A107	KIT 107-637	✓	214	A217	KIT 360TCFS	✓	210	
3586	SEE X003	166	4682	5KH35JN3132T	✓	170	A109	KIT 109	✓	222	A219	KIT 360TSCDS	✓	209	
3587	SEE X004	166	4684	5KH36MN3127T	✓	170	A109-(GE)	SEE AG109	✓	214	A222	KIT 400TSCDS	✓	209	
3588	SEE X005	166	4686	5KC46LN0269X	✓	171	A110	KIT 110	✓	215	A223	KIT 400TCFS	✓	210	
3589	SEE X009	166	4688	5KC49NN0061T	✓	171	A110-(GE)	SEE AG110	✓	214	A224-(GE)	SEE A105	✓	217	
3590	SEE X010	166	4701	5KH39QN5512T	✓	169	A111	KIT 111	✓	216	A225	KIT 400TSCDS	✓	209	
3596	SEE X023	166	4702	5KH33HN5725X	✓	169	A111-(GE)	SEE AG111	✓	214	A225-(GE)	SEE A106	✓	217	

Catalog Number/Model Number

CAT. NO.	MODEL NO.	STOCK	PAGE NO.	CAT. NO.	MODEL NO.	STOCK	PAGE NO.	CAT. NO.	MODEL NO.	STOCK	PAGE NO.	CAT. NO.	MODEL NO.	STOCK	PAGE NO.
A226	KIT 400TSCFS	✓	210	A417	KIT 444/5TCD-WD	✓	209	A565	KIT 10014130	✓	212	A647	KIT 250TDFPA	✓	211
A228	KIT 440TCDSD	✓	209	A419	KIT 447/9TCD-WD	✓	209	A566	KIT 11214130	✓	212	A648	KIT 250TDFNA	✓	211
A228-(GE)	SEE AG228		217	A424	KIT 400TCF2-WD	✓	210	A567	KIT 13214165	✓	212	A649	KIT 649R	✓	211
A229	KIT 440TCFS	✓	210	A425	KIT 400TCF-WD	✓	210	A568	KIT 16014215	✓	212	A650	KIT 650R	✓	211
A229-(GE)	SEE AG229		217	A426	KIT 444/5TCF2-WD	✓	210	A569	KIT 635115	✓	212	A651	KIT 651R	✓	211
A231	KIT 440TSCDS	✓	209	A427	KIT 444/5TCF-WD	✓	210	A570	KIT 715130	✓	212	A652	KIT 175068	✓	210
A232	KIT 440TSCFS	✓	210	A428	KIT 447/9TCF2-WD	✓	210	A571	KIT 805165	✓	212	A653	KIT 175191	✓	210
A234	KIT 234	✓	218	A429	KIT 447/9TCF-WD	✓	210	A572	KIT 905165	✓	212	A654	KIT 175061	✓	210
A239	KIT 250TCFPA	✓	210	A435	KIT 56CDR-1	✓	209	A573	KIT 1005215	✓	212	A655	KIT 145TCFN	✓	210
A240	KIT 240	✓	214	A436	KIT 140TCDR-1	✓	209	A574	KIT 1125215	✓	212	A656	KIT 280TDFNA	✓	211
A241	KIT 241	✓	214	A437	KIT 56CFR-1	✓	210	A575	KIT 1325265	✓	212	A657	KIT 320TDFPA	✓	211
A242	KIT 242	✓	214	A438	KIT 140TCFR-1	✓	210	A576	KIT 1605300	✓	212	A658	KIT 320TDFS	✓	211
A243	KIT 243	✓	216	A445	KIT 440-7.5	✓	216	A577	KIT 1805300	✓	212	A662	KIT 175614	✓	218
A244	KIT 244	✓	216	A446	KIT 440-10	✓	216	A578	KIT 2005350	✓	212	A666	KIT 175691	✓	210
A245	KIT 245	✓	216	A447	KIT 440-12.5	✓	216	A579	KIT 2255400	✓	212	A667	KIT 175844	✓	210
A247	KIT 247	✓	218	A448	KIT 440-15	✓	216	A580	KIT 175995	✓	212	A668	KIT A02H1024-BC LED	✓	221
A248	KIT 248	✓	218	A449	KIT 440-17.5	✓	216	A581	KIT 175985	✓	212	A669	KIT A02H2048-BC LED	✓	221
A249	KIT 249	✓	215	A459-(GE)	SEE A104		215	A581A	KIT 175817	✓	212	A686	KIT EPC260 2048	✓	221
A250	KIT 250	✓	215	A478-(GE)	SEE A111		216	A582	KIT 175987	✓	212	A687	KIT HS201024-NV	✓	221
A251	KIT 251	✓	215	A487-(GE)	SEE A243		216	A582A	KIT 175818	✓	212	A688-10	KIT A688-10	✓	221
A252	KIT 252	✓	215	A488-(GE)	SEE A244		216	A582B	KIT 175832	✓	212	A688-20	KIT A688-20	✓	221
A253	KIT 253	✓	215	A489-(GE)	SEE A245		216	A583	KIT 175989	✓	212	A688-25	KIT A688-25	✓	221
A254	KIT 254	✓	215	A493-(GE)	SEE A114		215	A583A	KIT 175819	✓	212	A688-30	KIT A688-30	✓	221
A256	KIT 256	✓	217	A494-(GE)	SEE A110		215	A584	KIT 175991	✓	212	A688-50	KIT A688-50	✓	221
A257	KIT 257	✓	217	A496	KIT EP2400	✓	222	A585	KIT 175900	✓	212	A688-60	KIT A688-60	✓	221
A258	KIT 258	✓	217	A499-1	KIT SGR-0.625-UK	✓	222	A586	KIT 175901	✓	212	A688-100	KIT A688-100	✓	221
A259	KIT 259	✓	216	A499-2	KIT SGR-0.875-UK	✓	222	A587	KIT 175902	✓	212	A690-15	KIT A690-15	✓	221
A261	KIT 261	✓	218	A499-3	KIT SGR-1.125-UK	✓	222	A588	KIT 175903	✓	212	A691	KIT 25TEBCNA	✓	220
A262	KIT 145TCTN-841	✓	211	A499-4	KIT SGR-1.375-UK	✓	222	A589	KIT 175833	✓	212	A692	KIT 21TEBC	✓	220
A277	KIT 277	✓	216	A499-5	KIT SGR-1.625-UK	✓	222	A590	KIT 175834	✓	212	A695	KIT 32TEBC	✓	220
A278	KIT 278	✓	216	A499-6	KIT SGR-1.875-UK	✓	222	A594	KIT 175619	✓	212	A696	KIT 36TEBC	✓	220
A279	KIT 279	✓	214	A499-7	KIT SGR-2.125-UK	✓	222	A596	KIT 175835	✓	212	A697	KIT 40TEBC	✓	220
A280	KIT 280	✓	214	A499-8	KIT SGR-2.375-UK	✓	222	A598	KIT 175836	✓	212	A698	KIT 44TEBC-313	✓	220
A281	KIT 281	✓	214	A499-9	KIT SGR-2.875-UK	✓	222	A600	KIT 175181	✓	209	A699	KIT 44TEBC-316	✓	220
A282	KIT 282	✓	214	A499-10	KIT SGR-3.375-UK	✓	222	A601	KIT 250TCFP	✓	210	A700	KIT 44TEBC-318	✓	220
A283	KIT 283	✓	214	A500-5	KIT SGR-11.2	✓	222	A602	KIT 175066	✓	209	A701	KIT 28TEBCNA	✓	220
A284	KIT 250TCFNA	✓	210	A500-8	KIT SGR-14.4	✓	222	A603	KIT 143TCFN	✓	210	A711	KIT HSD351024-NV	✓	221
A287	KIT 280TCDSD	✓	209	A500-14	KIT SGR-20.7	✓	222	A606	KIT 210TCDW	✓	209	A712	KIT HSD351024-FC	✓	221
A293	KIT 440TSCDN	✓	209	A500-20	KIT SGR-27.1	✓	222	A609	KIT 210TCFW	✓	210	A715	KIT 140CB	✓	220
A297	KIT 3BRK3A	✓	213	A500-26	KIT SGR-33.4	✓	222	A610	KIT 280TCDP	✓	209	A718	KIT 180R	✓	220
A298	KIT 6BRK3A	✓	213	A500-32	KIT SGR-39.8	✓	222	A611	KIT 280TCFP	✓	210	A720	KIT 180/210CB	✓	218
A299	KIT 10BRKA	✓	213	A500-38	KIT SGR-46.1	✓	222	A612	KIT 250TCDX	✓	209	A721	KIT 210R	✓	220
A301	KIT 3BRK3	✓	213	A500-44	KIT SGR-52.5	✓	222	A613	KIT 320TCDP	✓	209	A722	KIT 250CB	✓	218
A302	KIT 6BRK3	✓	213	A500-50	KIT SGR-58.8	✓	222	A614	KIT 320TCFP	✓	210	A723	KIT 250RFP	✓	220
A303	KIT 10BRK	✓	213	A500-62	KIT SGR-71.5	✓	222	A615	KIT 280TCFN	✓	210	A724	KIT 250RFNA	✓	220
A306	KIT 3BRK1	✓	213	A500-74	KIT SGR-84.2	✓	222	A617	KIT 280TCFPA	✓	210	A725	KIT 250R	✓	220
A307	KIT 6BRK1	✓	213	A518	161L110AAG4	✓	215	A618	KIT 280TCFNA	✓	210	A726	KIT 280RFP	✓	220
A308	KIT 308	✓	214	A534	161L187BAG1	✓	209	A619	KIT 320TCFPA	✓	210	A727	KIT 280RFN	✓	220
A311	KIT 311	✓	218	A535	161L187BCG1	✓	209	A620	KIT 440TCFN	✓	210	A728	KIT 280R	✓	220
A312	KIT BM6BRK	✓	213	A536	161L188BAG1	✓	210	A621	KIT 440TSCFN	✓	210	A729	KIT 280CB	✓	218
A313	KIT BM10BRK	✓	213	A537	161L188BCG1	✓	210	A622	KIT 175067	✓	209	A730	KIT 320CB	✓	218
A315	KIT BM6BRK575	✓	213	A549	S2A101229AAG1	✓	218	A623	KIT 449TCFS	✓	210	A731	KIT 280RFNA	✓	220
A316	KIT BM10BRK575	✓	213	A550	KIT 175828	✓	212	A624	KIT 449TSCFS-1	✓	210	A733	KIT 320RFP	✓	220
A317	KIT BM6BRK115	✓	213	A551	KIT 175829	✓	212	A625	KIT 449TSCFS-2	✓	210	A736	KIT HS35A1024-NV	✓	221
A318	KIT BM10BRK115	✓	213	A552	KIT 175830	✓	212	A626	KIT 175058	✓	209	A737	KIT HS35A1024-FC	✓	221
A371	KIT 370-3	✓	216	A553	KIT 175831	✓	212	A627	KIT 175059	✓	209	A738	KIT HS35A1024-BC	✓	221
A372	KIT 370-4	✓	216	A554	KIT 175984	✓	212	A628	KIT 175060	✓	209	A739	KIT HS35A2048-NV	✓	221
A373	KIT 370-5	✓	216	A554A	KIT 175810	✓	212	A629	KIT 175601	✓	209	A740	KIT HS35A2048-FC	✓	221
A375	KIT 370-7.5	✓	216	A555	KIT 175986	✓	212	A630	KIT 180TDFR	✓	211	A742	KIT HS35M1024	✓	221
A376	KIT 370-10	✓	216	A555A	KIT 175811	✓	212	A631	KIT 280TDFP	✓	211	A746	KIT HS25A1024-NV	✓	221
A378	KIT 370-15	✓	216	A555B	KIT 175827	✓	212	A632	KIT 320TDFP	✓	211	A747	KIT HS25A2048-NV	✓	221
A379	KIT 370-17.5	✓	216	A556	KIT 175988	✓	212	A634	KIT 400TDFS	✓	211	A748	KIT M561024BRK-140	✓	221
A380	KIT 370-20	✓	216	A556A	KIT 175812	✓	212	A637	KIT 360TDFC	✓	211	A749	KIT M561024BRK-182	✓	221
A381	KIT 370-25	✓	216	A557	KIT 175990	✓	212	A640	KIT 180TCN4.5	✓	210	A750	KIT M851024BRK-184	✓	221
A382	KIT 370-30	✓	216	A558	KIT 175890	✓	212	A641	KIT 180TCN8.5	✓	210	A751	KIT M851024BRK-210	✓	221
A395	KIT 360TCFSR	✓	210	A559	KIT 175994	✓	212	A642	KIT 175077	✓	210	A752	KIT M851024BRK-250	✓	221
A396	KIT 360TSCFSR	✓	210	A561	KIT 631475	✓	212	A643	KIT 175296	✓	210	A753	KIT M31024-NV	✓	221
A414	KIT 400TCD2-WD	✓	209	A562	KIT 711485	✓	212	A644	KIT 180CF8.5-1	✓	210	A754	KIT M31024-FC	✓	221
A415	KIT 400TCD-WD	✓	209	A563	KIT 8014100	✓	212	A645	KIT 180CF4.5-1	✓	210	A755	KIT 360BRFSR-314	✓	220
A416	KIT 444/5TCD2-WD	✓	209	A564	KIT 9014115	✓	212	A646	KIT 210TCN	✓	210	A756	KIT 400BRFS-316	✓	220

Index

Catalog Number/Model Number

CAT. NO.	MODEL NO.	STOCK	PAGE NO.	CAT. NO.	MODEL NO.	STOCK	PAGE NO.	CAT. NO.	MODEL NO.	STOCK	PAGE NO.	CAT. NO.	MODEL NO.	STOCK	PAGE NO.
A757	KIT 440BRFS-318	✓	220	A964	52A103486G1	✓	219	B334	SEE C475		171	C152A	184TTDW14078		40
A758	KIT 449BRFS	✓	220	A965	111A271P113	✓	216	B335	056B17D5703	✓	171	C1535	KC36LN30	✓	21
A759	KIT 440BRFN	✓	220	A1000	KIT 180-210 TERM BLK	✓	212	B336	056C17D5347	✓	25, 171	C1545	KC36LN30X	✓	21
A760	KIT 440BBFN	✓	220	A1001	KIT 250-320 TERM BLK	✓	212	B337	056C17D5348	✓	171	C155	SEE C155A		40
A761	KIT 449BBFS	✓	220	A1002	KIT 360 TERM BLK	✓	212	B338	056C17D5349	✓	171	C155A	254TTDX14089		40
A763	KIT LKSR02	✓	221	A1003	KIT 400-445 TERM BLK	✓	212	B348	SEE 4392		170	C156	SEE C156A		40
A764	KIT LKSR03	✓	221	A1004	KIT 447/9 TERM BLK	✓	212	B350	SEE C486		171	C156A	256TTDX14087		40
A772	KIT HS351024-NV	✓	221	A1209	KIT 250TCFLR	✓	210	B352	056B17D5331	✓	25, 171	C158	5KC36LN7	✓	21
A774	KIT HS351024-FC	✓	221	A1287	KIT 280TCDCA	✓	209	B353	056B17D67	✓	171	C159	5KC36LN7X	✓	21
A775	KIT HS351024-BC	✓	221	A1297	KIT BRK-3 575	✓	213	B380	SEE H209		174	C162	SEE C162A		40
A776	KIT HS352048-NV	✓	221	A1298	KIT BRK-6 575	✓	213	B381	SEE H214		174	C162A	145TTDR14087		40
A777	KIT HS352048-FC	✓	221	A1299	KIT BRK-10 575	✓	213	B383	SEE H171		169	C162-(GE)	SEE G1098		21
A778	KIT HS352048-BC	✓	221	A1301	KIT BRK-3 208-230/460	✓	213	B384	SEE H172		169	C163	SEE C123B		40
A779	KIT HS35B1024-NV	✓	221	A1302	KIT BRK-6 208-230/460	✓	213	B387	SEE H173		170	C164	5KC37NN15	✓	21
A779A	KIT HS35A/B1024-NV	✓	221	A1303	KIT BRK-10 208-230/460	✓	213	B388	SEE H174		170	C167	5KC49GN0010	✓	21
A780	KIT HS35B2048-NV	✓	221	A1306	KIT BRK-3 115/230	✓	213	B389	SEE H175		170	C168	5KC49GN0010X	✓	21
A780A	KIT HS35A/B2048-NV	✓	221	A1307	KIT BRK-6 115/230	✓	213	B400	048S17D997	✓	159	C169	5KC49GN0010Y	✓	21, 187
A781	KIT HS35B1024-BC	✓	221	AG109	161L113AAG1	✓	214	B401	056S17D2062	✓	159	C173	182TCDR8007		27
A782	KIT HS35B2048-BC	✓	221	AG110	161L113AAG2	✓	214	B402	048S17D7209	✓	159	C174	184TCDR7627		27
A783	KIT HS35B1024-FC	✓	221	AG111	161L113AAG3	✓	214	B500	SEE H236		172	C175	5KC46LN0153	✓	21
A783A	KIT HS35A/B1024-FC	✓	221	AG112	161L113AAG4	✓	214	B501	SEE H234		172	C176	5KC46LN0153X	✓	21
A784	KIT HS35B2048-FC	✓	221	AG113	161L113AAG5	✓	214	B502	SEE B1502		172	C177	5KC46LN0153U	✓	21
A784A	KIT HS35A/B2048-FC	✓	221	AG114	161L113AAG6	✓	214	B504	SEE B1504		172	C178	5KCR49WN6075	✓	21
A785	KIT LKSR512	✓	221	AG115	161L113AAG9	✓	214	B506	056S17F5303		172	C179	5KC38RN60	✓	21
A786	KIT LKSR-CFACE	✓	221	AG125	161L113ADG1	✓	214	B507	SEE B1507		172	C180	5KC38RN60X	✓	21
A787	KIT 449BBFS-322	✓	220	AG127	161L113ADG3	✓	214	B600	SEE H176		170	C181	5KC49PN0161	✓	21
A788	KIT 449BBFS-319	✓	220	AG128	161L113ADG4	✓	214	B604	SEE H169		169	C182	5KC49PN0161X	✓	21
A789	KIT SL561024-182NV	✓	221	AG129	161L113ADG5	✓	214	B605	SEE H170		169	C183	5KCR49QN6076	✓	21
A790	KIT SL851024-184NV	✓	221	AG130	161L113ADG14	✓	214	B606	048S17D2116	✓	169	C185	5KCR49SN0068	✓	22
A791	KIT SL851024-210NV	✓	221	AG195	161L110AA1	✓	215	B607	048S17D2117	✓	170	C186	5KCR49SN0068X	✓	22
A792	KIT SL851024-250NV	✓	221	AG212	161L185AAG1	✓	209	B608	056C17D2113	✓	171	C187	5KC48TN2169	✓	22
A793	KIT M561024-NV	✓	221	AG215	161L186AAG1	✓	210	B609	056B17D2013	✓	171	C188	5KC49PN0162	✓	21
A794	KIT M561024-BC	✓	221	AG228	112A515AKG4	✓	217	B703	048N17D14	✓	170	C191	5KCR49SN0065	✓	22
A795	KIT L449BBFS-322	✓	220	AG229	112A515ASG2	✓	217	B1316	5KC49GN0001	✓	24, 171	C193	5KCR49WN0270	✓	22
A796	KIT L449TEBC	✓	220	AG234	161L528AAG1	✓	218	B1502	5KH39QN9105	✓	172	C194	5KCR48TN8062	✓	22
A800	KIT 56 EXPR BOX	✓	218	AG697	161L210AAP1	✓	219	B1504	5KH35MN56	✓	172	C200	5KC35JN12	✓	24
A801	KIT ENCB0X	✓	221	B100	056S17D2064	✓	170	B1507	5KH42GN0336	✓	172	C201	143TTFR5302	✓	51
A803	KIT LDRDCR-M	✓	218	B193	056T34D5357	✓	173	C102	SEE C102A		40	C201A	143TTFR4302	✓	51
A807	KIT STUBSHAFT 1IN	✓	221	B200	056S17D2049	✓	170	C102A	145TTDR14007	✓	40	C201-(GE)	SEE CG201		24
A903	KIT 903	✓	213	B201	056S17D2047	✓	169	C103	145TTDR5312	✓	40	C202	SEE C202A		51
A904	KIT 904	✓	213	B202	056S17D2048	✓	170	C104B	182TTDW14008	✓	40	C202A	145TTFR4306	✓	51
A905	KIT 905	✓	213	B206	048S17D2107	✓	169	C105	SEE C105B		40	C202-(GE)	SEE G1114		24, 171
A906	KIT 906	✓	213	B207	048S17D2108	✓	170	C105B	184TTDW14017	✓	40	C203	SEE C203B		52
A907	KIT 907	✓	213	B208	048S17D2109	✓	170	C105-(GE)	SEE CG105		23	C203B	182TTFW14004	✓	52
A908	KIT 908	✓	213	B210	SEE C216		24, 171	C106	SEE C106A		40	C203-(GE)	SEE G1115		24, 171
A909	KIT 909	✓	213	B300	048S17D2052	✓	169	C106A	213TTDW14014	✓	40	C204	SEE C204B		52
A910	KIT 910	✓	213	B302	048S17D2054	✓	169	C111	SEE K1301		40	C204B	184TTFW14004	✓	52
A911	KIT 911	✓	213	B303	048S17D2055	✓	169	C111-(GE)	SEE CG111		23	C205	SEE C205A		52
A940	52D310833AAP001	✓	219	B304	048S17D2056	✓	170	C120	SEE K634A		40	C205A	213TTFW14011	✓	52
A941	52D311808ARP1	✓	219	B305	048S17D2057	✓	170	C121	SEE K622		40	C206	SEE C206A		52
A942	52D310814AAP1	✓	219	B306	048S17D2058	✓	170	C122A	145TTDR4341	✓	40	C206A	215TTFW14024	✓	52
A945	115D964P1	✓	219	B307	048S17D2059	✓	170	C123	182TTDR8067	✓	40	C207	SEE C207A		52
A946	115D964P2	✓	219	B308	SEE H208		174	C123B	182TTDW4028	✓	40	C207A	254TTFW14009		52
A947	115D963P1	✓	219	B309	SEE H212		174	C124	SEE C124B		40	C208	5KC35FN51X	✓	24
A948	113A617AG001	✓	219	B310	SEE C235		24, 171	C124A	SEE C124B		40	C209	5KC36LN26	✓	24
A949	113A620AYP1	✓	219	B311	SEE 4688		171	C124B	184TTDW14027	✓	40	C210	5KC36LN26X	✓	24
A950	976B399AAP9	✓	219	B312	048C17D2041	✓	171	C125	SEE C125A		40	C215	5KC36LN1	✓	24
A951	976B399AAP12	✓	219	B313	048C17D2042	✓	171	C125A	213TTDW14057	✓	40	C216	5KC36LN1X	✓	24, 171
A952	976B399AAP13	✓	219	B314	048C17D2043	✓	171	C126	SEE C126A		40	C220	SEE C220A		51
A953	976B399ABP6	✓	219	B315	048C17D2044	✓	171	C126A	215TTDW14071	✓	40	C220A	143TTFR4329	✓	51
A954	976B399ABP9	✓	219	B316	SEE B1316		24, 171	C129	5KC35JN23X		26	C221	SEE C221A		51
A955	976B399ABP10	✓	219	B317	056C17D2072	✓	24, 171	C133	5KC36MN27X	✓	26	C221A	145TTFR4332	✓	51
A956	161L198AAG9	✓	219	B318	056C17D2073	✓	24, 171	C136	SEE S113		26	C221-(GE)	SEE B1316		24, 171
A957	161L198AAG10	✓	219	B319	056C17D2074	✓	24, 171	C138	5KC46JN0002X	✓	24	C222	SEE K2033		51
A958	161L197ABG1	✓	219	B320	SEE H217		174	C145	5KC35JN8X	✓	21	C223	SEE C223B		52
A959	161L197ABG11	✓	219	B321	SEE H290		174	C147	5KC35JN10	✓	21	C223B	182TTFW4027	✓	52
A960A	003062.09	✓	219	B322	048S17D2053	✓	169	C148	5KC35JN10X	✓	21	C223-(GE)	SEE CG223		24
A961	111A271P111	✓	219	B330	SEE C1160		25, 171	C150	SEE C150A		40	C224	SEE C1224		52
A962	52D310822ACP1	✓	219	B331	SEE C420		171	C150A	145TTDR14088	✓	40	C225	SEE C225A		52
A963	52D311819ABP1	✓	219	B332	056B17D5701		171	C152	SEE C152A		40	C225A	213TTFW14045	✓	52

Catalog Number/Model Number

CAT. NO.	MODEL NO.	STOCK	PAGE NO.	CAT. NO.	MODEL NO.	STOCK	PAGE NO.	CAT. NO.	MODEL NO.	STOCK	PAGE NO.	CAT. NO.	MODEL NO.	STOCK	PAGE NO.
C226	SEE C226A		52	C302	SEE C302A		77	C367-(GE)	SEE G1513		31	C459	5KC37MN96	✓	21
C226A	215TTFW14041	✓	52	C302A	145TTGN4022		77	C368	SEE C368A		75	C460	5KC36LN19X	✓	24
C227	SEE C227A		52	C303	SEE C303A		77	C368A	182TTGN6536	✓	75	C462	5KC33KN19	✓	29
C227A	254TTF14037	✓	52	C303A	182TTGN4315	✓	77	C368-(GE)	SEE G1515		31	C465	5KC39QN3218X	✓	121
C230	143TTFR5333		51	C304	SEE C304A		77	C369	SEE C369A		75	C466	5KCR49TN2155T	✓	31
C230A	143TTFR4333		51	C304A	184TTGN4313	✓	77	C369A	184TTGN6537	✓	75	C474	5KCR49PN3011X	✓	25,171
C230-(GE)	SEE CG230		24,171	C305	213TTGS14015	✓	77	C369-(GE)	SEE G1517		31	C475	5KCR49SN3009	✓	25,171
C231	145TTFR5340		51	C306	215TTGS14020	✓	77	C370	SEE C370A		75	C476	5KCR49SN3010	✓	25,171
C231A	145TTFR4340		51	C307	SEE C307A		77	C370A	213TTGN6536	✓	75	C486	5KCR49PN3012X	✓	25,171
C231-(GE)	SEE D1113		24,171	C307A	254TTGP14013	✓	77	C370-(GE)	SEE G1519		31	C548	5KC49PN6051X	✓	24
C232	145TTFR5341		51	C308	SEE C308A		77	C371	SEE C371A		75	C552	5KC48UN6052X	✓	24
C232A	145TTFR14048		51	C308A	256TTGN14011		77	C371A	215TTGN16534		75	C636	SEE S117		26
C232-(GE)	SEE CG232		24	C320	SEE C320A		77	C371-(GE)	SEE G1531		31	C646	5KC36PN169X	✓	34
C235	5KC49PN0155	✓	24,171	C320A	143TTGN4062	✓	77	C375	5KC42GN0066	✓	32	C659	5KCR48WN0566Y	✓	99
C236	SEE C236A		52	C321	SEE C321A		77	C376	5KC49TN0067	✓	32	C660	5KC49TN0568Y	✓	99
C236A	145TTFR4307	✓	52	C321A	145TTGN4337	✓	77	C380	SEE C380B		54	C661	5KC46GN0569Y	✓	99
C236-(GE)	SEE CG236		24	C322	SEE C322A		77	C380B	184TTFW16051	✓	54	C662	5KC49SN2418U	✓	99
C237	SEE C237A		52	C322A	145TTGN4338	✓	77	C381	SEE C381B		54	C663	5KC49NN2419Y	✓	99
C237A	215TTFW14022	✓	52	C323	SEE C323A		77	C381B	182TTFW16021	✓	54	C664	5KC36LN4003Y	✓	99
C238	SEE C238B		52	C323A	182TTGN4068	✓	77	C381-(GE)	SEE CG381		22	C683	5KC36LN84X	✓	121
C238B	184TTFW14021	✓	52	C324	SEE C324A		77	C382	SEE C382B		54	C702	5KC38RN4153Y	✓	21
C239-(GE)	SEE CG239		25	C324A	184TTGN4072	✓	77	C382B	182TTFW16030	✓	54	C703	5KC49NN2520Y	✓	22
C242	5KC32GN9	✓	29	C325	SEE C325A		77	C382-(GE)	SEE CG382		190	C704	5KC49PN2521Y	✓	22,187
C243	5KC32GN9X	✓	29	C325A	213TTGN4067	✓	77	C383	SEE C383A		54	C732-(GE)	SEE CG732		121
C247	5KC32GN13	✓	172	C326	SEE C326A		77	C383A	182TTFW4345		54	C806	5KC49PN0281X	✓	172
C248	5KC49PN3036	✓	29	C326A	215TTGN4065	✓	77	C383B	182TTFW16027	✓	54	C847	5KC37NN115X	✓	121
C250	SEE C250A		51	C327	SEE C327A		77	C383-(GE)	SEE CG383		190	C855	5KC49SN2156X	✓	31
C250A	145TTFR4378	✓	51	C327A	254TTGN14042	✓	77	C384	SEE C384A		54	C878	5KCR49TN2164T	✓	121
C250-(GE)	SEE G1312		29	C328	SEE C328A		77	C384A	213TTFW16078	✓	54	C1081	5KC39EN2553X	✓	120
C251	SEE C251A		51	C328A	256TTGN14044	✓	77	C384-(GE)	SEE CG384		190	C1082	5KC39HN2554X	✓	120
C251A	—		51	C328-(GE)	SEE J1025		121,176	C385	SEE C385B		54	C1083	5KC33MN2555X	✓	120
C251-(GE)	SEE CG251		29	C329	5KC37FN65X	✓	121	C385B	184TTFW16006	✓	54	C1083A	5KC39PN5105X	✓	120
C252	SEE C252A		51	C330	5KC36JN268X	✓	121,176	C386	SEE C386B		54	C1084	5KC39SN2810X	✓	120
C252A	—		51	C331	5KC36JN269X	✓	121	C386A	SEE C386B		54	C1085	5KCR39SN2557X	✓	120
C252-(GE)	SEE G1316		29	C332	5KC39NN50X	✓	121,176	C386B	184TTFW16027	✓	54	C1086	5KCR39UN2558X	✓	120
C253	SEE C253A		52	C333	5KC39QN3219X	✓	121	C387	SEE C387B		54	C1087	5KC39EN2500X	✓	120
C253A	213TTFW14081		52	C334	5KC39RN44X	✓	121,176	C387A	SEE C387B		54	C1088	5KC39HN2501X	✓	120
C254	SEE C254A		52	C335	5KC39RN45X	✓	121	C387B	184TTFW16029	✓	54	C1089	5KC33MN2502X	✓	120
C254A	215TTFW14084		52	C336	5KC49NN2140X	✓	121,176	C388	SEE C388A		54	C1089A	5KC39PN6200X	✓	120
C254-(GE)	SEE G1330		29	C337	5KC49NN2167X	✓	121	C388A	215TTFW16079	✓	54	C1090	5KC39SN2812X	✓	120
C255	SEE C255A		52	C338	5KC49TN2141X	✓	121,176	C389	SEE C389A		55	C1091	5KCR39SN2504X	✓	120
C255A	254TTF14078		52	C339	5KC49TN2170X	✓	121	C389A	213TTFW16008	✓	55	C1092	5KCR39UN2505X	✓	120
C255-(GE)	SEE G1331		29	C340	5KCR48TN2142T	✓	121,176	C390	SEE C390A		55	C1104	SEE C104B		40
C256	SEE C256A		52	C341	5KCR48TN2174T	✓	121	C390A	213TTFW16035	✓	55	C1105	SEE C105B		40
C256A	256TTFNA14086		52	C349	5KC36LN166X	✓	31	C391	213TTFW4345		55	C1123	SEE C123B		40
C257-(GE)	SEE C1333		29	C351	5KC49NN2133X	✓	31	C391A	213TTFW16036	✓	55	C1152	5KC39QN3220X	✓	24,171
C260	SEE C223B		52	C352	5KC49NN2135X	✓	121	C392	SEE C392A		55	C1153	5KC49GN0022X	✓	24,171
C260-(GE)	SEE CG260		29	C354	5KC35JN70X	✓	27	C392A	215TTFW16005	✓	55	C1154	5KC38NN413X	✓	24,171
C261	5KC42GN0014	✓	29	C355	SEE G230		27	C393	SEE C393A		55	C1155	5KC38NN410X	✓	24,171
C262	5KC42GN0014X	✓	29	C356	5KC36LN83X	✓	27	C393A	215TTFW16041	✓	55	C1156	5KC46LN0149X	✓	24,171
C264	5KC49UN6065	✓	29	C358	SEE G234		27	C393-(GE)	SEE CG393		23	C1157	5KC39RN383X	✓	24,171
C268	5KC46PN0015	✓	29	C359	5KC49GN0009X	✓	27	C394	215TTFW4345		55	C1158	5KC49PN0164X	✓	24,171
C269	5KC46PN0015X	✓	29	C361	SEE C361A		75	C394A	215TTFW16042		55	C1159	5KC49RN2152T	✓	25,171
C271	5KCR48WN6066	✓	29	C361A	143TTGN6551	✓	75	C400	145TTFR5382	✓	98	C1160	5KCR49SN0150X	✓	25,171
C273	5KC49NN2130X	✓	30	C361-(GE)	SEE CG361		27	C401	145TTFR5360	✓	98	C1161	5KCR49RN2148T	✓	25,171
C274	5KC49NN2130Y	✓	30	C362	SEE C362A		75	C402	184TTTL7084	✓	98	C1162	SEE B352		25,171
C275	5KC49TN00034	✓	30	C362A	145TTGN6536	✓	75	C403	145TTFR5359	✓	98	C1168	5KC36GN2507X	✓	120
C276	5KC49TN00034X	✓	30	C362-(GE)	SEE CG362		27	C404	184TTTL7083	✓	98	C1169	5KC36MN2508X	✓	120
C281	145TBF5337		32	C363	SEE C363A		75	C405	182TTTL7034	✓	98	C1170	5KC38PN2509X	✓	120
C281-(GE)	SEE G1376		30	C363A	145TTGN6549	✓	75	C406	184TTTL7041	✓	98	C1171	5KC38SN2510X	✓	120
C282	145TBF5305		32	C363-(GE)	SEE CG363		27	C407	213TTTL7034	✓	98	C1172	5KCR39UN2511X	✓	120
C282-(GE)	SEE G1377		30	C364	SEE C364A		75	C408	215TTTL7050	✓	98	C1173	5KCR39UN2512X	✓	120
C284	145TBF5306		32	C364A	182TTGN6569	✓	75	C419	5KCR49PN3027X	✓	25,171	C1187	5KC49NN0224X	✓	24
C284-(GE)	SEE G1392		30	C365	SEE C365A		75	C420	5KCR49PN3011	✓	25,171	C1203	SEE C203B		52
C289	5KC42GN0309X	✓	172	C365A	184TTGN6575	✓	75	C431	5KC36LN18	✓	21	C1204	SEE C204B		52
C292	5KC49TN0285X	✓	172	C366	SEE C366A		75	C444	5KC36LN144X	✓	32	C1223	SEE C223B		52
C295	5KC49TN00033	✓	30	C366A	213TTGN6528	✓	75	C445	5KC49NN2132X	✓	32	C1224	184TTFW8641	✓	52
C297	5KCR48WN0292	✓	30	C366-(GE)	SEE G1511		31	C446	5KC42GN0018X	✓	31	C1238	SEE C238B		52
C301	SEE C301A		77	C367	SEE C367A		75	C449	5KC37NN160	✓	23	C1252	5KC49PN6070	✓	21
C301A	143TTGN4020		77	C367A	215TTGN6528	✓	75	C457	5KC37NN14T	✓	24	C1258	5KC49PN6051	✓	24

Index

Catalog Number/Model Number

CAT. NO.	MODEL NO.	STOCK	PAGE NO.	CAT. NO.	MODEL NO.	STOCK	PAGE NO.	CAT. NO.	MODEL NO.	STOCK	PAGE NO.	CAT. NO.	MODEL NO.	STOCK	PAGE NO.
C1263	5KC48UN6073	✓	21	C1809	5KC49SN6375X		34	D396	056T34F5306	✓	54	E135	145TTDR4066		125
C1264	5KC48UN6052	✓	24	C1810	5KC49QN4559X	✓	34	D400	056C17F5352	✓	97	E136	145TTDR4046		125
C1269	5KC49SN2537Y	✓	28	C1811	SEE G659		34	D401	056C17F5353	✓	97	E137	145TTDR4067		125
C1270	5KC49Z2539Y	✓	28	C1812	SEE G853		35	D402	056C17F5354	✓	97	E138	145TTDR4051	✓	125
C1273	5KC49SN8060T	✓	159	C1813	SEE G854		35	D403	056C17F5355	✓	97	E139	145TTDR4073		125
C1274	5KCR49TN8058T	✓	159	C1814	5KC49HN2509X	✓	35	D404	056B17F5330	✓	97	E140	145TTDR4115		125
C1275	5KCR49Z2N8061T	✓	159	C1815	SEE G855		35	D450	056T17F5348	✓	98	E141	145TTDR4121		125
C1285	SEE N559		105	C1816	5KC49QN0718X	✓	35	D451	056T11F5325	✓	98	E142	145TTDR4307		125
C1286	SEE N541		105	C1817	5KC49SN6380X	✓	35	D452	056T17F5349	✓	98	E143	145TTDR4110		125
C1287	SEE N542		105	C1818	5KC49MN6379X	✓	35	D453	056T11F5326	✓	98	E144	145TTDR4025		125
C1288	SEE N543		105	C1904	SEE Z128		99	D454	056T17F5350	✓	98	E145	182TTDR4140		126
C1289	SEE N544		105	C1909	5KCR49Z2N0785S	✓	102	D455	056T11F5327	✓	98	E146	182TTDR4146		126
C1290	SEE N545		105	CG105	5KC35JN27Y		23	D456	056T17F5357	✓	98	E147	182TTDR4036		126
C1291	5KC46GN0075U	✓	100	CG111	5KC37LN91	✓	23	D457	056T17F5358	✓	98	E148A	182TTDW4135	✓	126
C1292	5KC46JN0076U	✓	100	CG201	5KC35JN12X	✓	24	D1113	5KC46LN0158X	✓	24,171	E149A	182TTDW4147		126
C1293	5KCR49PN0077U	✓	100	CG223	5KC49GN0001X	✓	24	E12D4	5KS49HN4077	✓	36	E150	SEE E150A		126
C1294	5KCR49UN0079U	✓	100	CG230	5KC46LN0158	✓	24,171	E34D4	5KS46MN4078	✓	36	E150A	182TTDW4116		126
C1295	5KCR49WN0295U	✓	100	CG232	5KCR49WN6077	✓	24	E001	SEE GT1105		61	E151	182TTDR4122		126
C1296	SEE G212		27	CG236	5KCR49PN0155X	✓	24	E002	184TTFC6081	✓	57	E152	182TTDR4117		126
C1297	SEE G256		27	CG239	5KCR49SN0012X	✓	25	E003	SEE GT1111		61	E153A	182TTDW4304	✓	126
C1298	5KC46NN0758Y	✓	21	CG251	5KC32GN19X	✓	29	E004	SEE GT1114		61	E154	182TTDR4123		126
C1299	5KCR48WN0756Y		22,187	CG260	5KC37RN35	✓	29	E005	254TTFC6081	✓	57	E155	184TTDR4140		126
C1302	5KCR49SN0042S	✓	102	CG361	5KC46LN0159	✓	27	E006	256TTFC6081	✓	58	E156	184TTDR4146		126
C1303	5KCR46NN0264T	✓	102	CG362	5KC46LN0159X	✓	27	E007	SEE GT1123		61	E157	184TTDR4141		126
C1314	5KCR49PN0492S	✓	102	CG363	5KC49PN0163X	✓	27	E008	286TTFC6081	✓	58	E158A	184TTDW4135	✓	126
C1315	5KCR49SN0493S	✓	102	CG381	5KCR49WN0270T	✓	22	E009	SEE GT1129		62	E159	184TTDR4147		126
C1333	5KCR49PN6062	✓	29	CG382	5KC35GNA488	✓	190	E010	SEE GT1132		62	E160	184TTDR4115		126
C1336	5KC33FN4180X	✓	121	CG383	5KC35JNA489	✓	190	E011	324TSTFC6006	✓	59	E161	184TTDR4121		126
C1380	SEE C380B		54	CG384	5KC35JNA489Y	✓	190	E012	SEE GT1135		62	E162	184TTDR4116		126
C1381	SEE C381B		54	CG393	5KC36MN20	✓	23	E013	326TSTFC6006	✓	59	E163A	184TTDW4005	✓	126
C1382	SEE C382B		54	CG732	5KC39RN114T	✓	121	E014	SEE GT1138		62	E164	184TTDR4122		126
C1385	SEE C385B		54	D010	056B34D2029	✓	21,187,193	E015	364TSTFC6006	✓	59	E165	213TTDW4042		126
C1404	5KC49UN6067	✓	31	D012	SEE 9035		23,187	E016	365TSTFC6006	✓	59	E166	213TTDW4041		126
C1405	5KC35MN145	✓	32	D013	SEE 9036		22,188	E095	143TTDR14004		125	E167	213TTDW4033		126
C1412	5KCR49WN6078		32	D014	SEE 9031		21,187	E096	145TTDR4317	✓	125	E168	213TTDW4048	✓	126
C1419	5KC33FN31	✓	31	D015	SEE 9032		21,187,193	E097	182TTDW14029	✓	125	E169	213TTDW4038		126
C1420	5KC36LN144	✓	32	D017	056B34D5302	✓	22,188	E098	182TTDW4006	✓	126	E170	213TTDW4009		126
C1422	5KC48UN6072	✓	27	D018	SEE C704		22,187	E100	143TTDR4035	✓	125	E171	213TTDW4010		126
C1423	5KC49MN6063		31	D107	048S17D2017	✓	169	E102	145TTDR4034	✓	125	E172	213TTDW4008		126
C1424	5KC49SN2158	✓	31	D110	SEE C1152		24,171	E104	145TTDR4060	✓	125	E173	213TTDW4023	✓	126
C1425	5KC49PN0283	✓	32	D111	056C17D2079	✓	24,171	E105	145TTDR4303		125	E174	213TTDW4007		126
C1458	5KC46GN0251	✓	190	D113	SEE D1113		24,171	E106A	182TTDW4336	✓	126	E175	215TTDW4041		126
C1459	5KC46GN0251Y	✓	190	D114	SEE C1158		24,171	E107A	182TTDW4325	✓	126	E176	215TTDW4042		126
C1460	5KC46LN0252	✓	190	D115	056B34D2027	✓	25,171	E108	184TTDR4034	✓	126	E177	215TTDW4043		126
C1461	5KC46LN0252Y	✓	190	D116	SEE C1161		171	E109A	184TTDW14001	✓	126	E178	215TTDW4048	✓	126
C1462	5KC39HN2888X	✓	120	D117	SEE C1155		24,171	E110	213TTDW4047	✓	126	E179	215TTDW4032		126
C1463	5KC33MN2889X	✓	120	D118	056C34D2106	✓	24,171	E111	213TTDW4022	✓	126	E180	215TTDW4008		126
C1463A	5KC39PN6201X	✓	120	D119	048C17D2055	✓	171	E112	215TTDW4047	✓	126	E181	215TTDW4009		127
C1464	5KC39SN2890X	✓	120	D127	SEE 4305		169	E113	215TTDW4022	✓	127	E182	215TTDW4010		126
C1465	5KCR39SN2891X	✓	120	D129	SEE 4306		169	E114A	254TTDX14062	✓	127	E183	215TTDW4023	✓	127
C1466	5KCR39UN2892X	✓	120	D143	048S17D2086	✓	170	E115	143TTDR4040		125	E184	215TTDW4007		127
C1467	5KC37NN3544T	✓	159	D145	SEE H167		170	E116	143TTDR4047		125	E185	254TTDX4343		127
C1468	5KC49NN2081T	✓	159	D149	056S17D2050	✓	170	E117	143TTDR4041		125	E186	254TTDX4344		127
C1469	5KC49PN0253	✓	190	D162	048S17D2087	✓	170	E118	143TTDR4034	✓	125	E187	254TTDX4345		127
C1474	5KC37LN502Y	✓	21	D163	048S17D2088	✓	170	E119	143TTDR4046		125	E188	254TTDX4039	✓	127
C1475	5KC37NN501Y	✓	21	D164	SEE 4338		170	E120	143TTDR4016		125	E190	254TTDX4007		127
C1477	5KC49PN2144Y	✓	22	D180	048S17D7204		169	E121	143TTDR4022		125	E191	254TTDX4006	✓	127
C1478	5KCR49SN3009X	✓	25,171	D181	048S17D7205	✓	170	E122	143TTDR4017		125	E192	254TTDX4019		127
C1479	5KCR48TN3084X	✓	25,171	D311	056C34F5301	✓	33	E123	143TTDR4009	✓	125	E193	254TTDX4015		127
C1480	5KC49PN0161U	✓	21,187,193	D312	056C34F5302	✓	33	E124	143TTDR4024		125	E194	254TTDX4020		127
C1483	5KC46LN0254X	✓	26	D313	056C34F5303	✓	33	E125	145TTDR4040		125	E195	254TTDX4024		127
C1489	5KC46PN0359Y	✓	190	D314	056B34F5326	✓	33	E126	145TTDR4072		125	E197	256TTDX4075	✓	127
C1801	5KC49MN6384X	✓	34	D315	056B34F5327	✓	33	E127	145TTDR4041		125	E198	256TTDX4326		127
C1802	SEE G650		34	D316	056B34F5328	✓	33	E128	145TTDR4035	✓	125	E199	256TTDX4329		127
C1803	5KC49HN0719X	✓	34	D390	056T34T5303	✓	53	E129	145TTDR4047		125	E202-P	184TTFN16056	✓	57
C1804	SEE G651		34	D391	056T34F5301	✓	53	E130	145TTDR4015		125	E203-P	213TTFN16326	✓	57
C1805	SEE G652		34	D392	056T34F5302	✓	53	E131	145TTDR4021		125	E204-P	215TTFN16057	✓	58
C1806	SEE G653		34	D393	056T34F5303	✓	53	E132	145TTDR4016		125	E205	254TTFNA6026	✓	58
C1807	5KC49QN0716X	✓	34	D394	056T34F5304	✓	54	E133	145TTDR4010	✓	125	E205-P	254TTFNA16074	✓	58
C1808	SEE G654		34	D395	056T34F5305	✓	54	E134	145TTDR4022		125	E206	256TTFNA6026	✓	58

CAT. NO.	MODEL NO.	STOCK	PAGE NO.	CAT. NO.	MODEL NO.	STOCK	PAGE NO.	CAT. NO.	MODEL NO.	STOCK	PAGE NO.	CAT. NO.	MODEL NO.	STOCK	PAGE NO.
E206-P	256TTFNA16070	✓	58	E276	449TTFS6038		60	E369	—		70	E500	254TTGN6576	✓	80
E207	284TTFNA6026	✓	58	E276-(GE)	SEE EG276		29	E373	143TTFN6576		67	E501	256TTGN6576	✓	80
E207-P	284TTFNA16070	✓	58	E277	449TTFS6037		60	E374	143TTFN6526		67	E502	254TTGN6507	✓	80
E208	286TTFNA6026	✓	58	E277-(GE)	SEE EG277		28	E375	143TTFN6563		67	E503	254TTGN6531	✓	80
E208-P	286TTFNA16328	✓	58	E278	SEE EG256		27	E376	143TTFN16539		67	E503-P	254TTGN16549	✓	80
E209	324TTF6026	✓	59	E280	5KCR48UN0104	✓	21	E377	143TTFN6501		67	E504	284TTGN6576	✓	80
E209-P	324TTF616066	✓	59	E281	5KCR48UN0105X	✓	24	E378	143TTFN6502		67	E505	256TTGN16509	✓	80
E210	326TTF6026	✓	59	E282	449TTFS6088	✓	60	E379	143TTFN6505		67	E506	256TTGN6531	✓	80
E210-P	326TTF616073	✓	59	E282-(GE)	SEE EG282		32	E380	182TTF6576		67	E506-P	256TTGN16552	✓	80
E211	364TTF6036	✓	59	E283	449TTFS6087		60	E382	145TTFN6501		67	E507	286TTGN16577	✓	80
E212	365TTF6036	✓	59	E283-(GE)	SEE EG283		31	E383	145TTFN6521		67	E546	284TSTGN6503	✓	80
E213	405TTF6036	✓	59	E284	449TTFS6390		60	E386	145TTFN6835		68	E547	284TTGN6533	✓	80
E214	444TTF6036	✓	60	E284-(GE)	SEE EG284		32	E388	184TTF6576		68	E547-P	284TTGN16550	✓	80
E215	445TTF6036	✓	60	E285	5KCR49UN0108	✓	30	E390	182TTF6501		68	E563	286TSTGN6501	✓	80
E216	182TTTS6001	✓	57	E286	5KS49HN4595	✓	106	E392	182TTF6505		68	E564	286TTGN6537	✓	80
E218	213TTTS6001	✓	57	E287	445TTFN6040		60	E396	213TTF6501		68	E564-P	286TTGN16546	✓	80
E220	254TTFNA6001	✓	58	E287-(GE)	SEE N322		106	E400	326TTF6580		69	E565	326TTGS6578	✓	80
E221	256TTFNA6001	✓	58	E288	SEE N320		106	E401	SEE E401A		69	E566	324TSTGS6501	✓	80
E222	284TSTFNA6001	✓	58	E289	445TTFN6087		60	E401A	364TTF616585		69	E567	324TTGS6529	✓	80
E223	286TSTFNA6001	✓	58	E290	SEE N310		106	E402	SEE E402A		69	E567-P	324TTGS16541	✓	80
E224	324TSTFS6001	✓	59	E291	449TTFS16334		60	E402A	365TTF616592		69	E568	SEE E568A		80
E225	326TSTFS6001	✓	59	E292	449TTFS6065		60	E403	404TTF6592		69	E568A	364TTGS16577	✓	80
E226	364TSTFS6001	✓	59	E293	449TTFS16333		60	E404	405TTF6587		69	E569	326TSTGS6501	✓	80
E227	365TSTFS6001	✓	59	E294	SEE N642		107	E405	SEE E405A		70	E570	326TTGS6532	✓	80
E228	405TSTFS6001	✓	59	E295	SEE N644		107	E405A	444TTFN16582		70	E570-P	326TTGS16546	✓	80
E229	444TSTFS6001	✓	60	E296	SEE N646		107	E406	445TTFN6590		70	E571	365TTGS16577	✓	80
E230	445TSTFN6001	✓	60	E297-(GE)	SEE N647		107	E407	445TTFN6591		70	E572	364TSTGS6506	✓	80
E235	254TTFNA6076	✓	57	E302-(GE)	SEE N566		108	E408	449TTFS6582		70	E573	SEE E573A		80
E236	256TTFNA6076	✓	58	E303	182TTTS6030		57	E448	445TTFN6587	✓	70	E573A	364TTGS16536	✓	80
E237	284TTFNA6076	✓	58	E303-(GE)	SEE N567		108	E449	445TTFN6505	✓	70	E574	404TTGS6588	✓	80
E238	286TTFNA6076	✓	58	E304-(GE)	SEE N622		108	E450	445TTFN6540		70	E575	365TSTGS16503	✓	81
E239	324TTF6076	✓	58	E305-(GE)	SEE N569		108	E453	326TSTFS6536		69	E576	SEE E576A		81
E240	326TTF6076	✓	59	E306	215TTF6030		58	E454	364TSTFS6526		69	E576A	365TTGS16540	✓	81
E241	SEE E241A		59	E306-(GE)	SEE N599		108	E455	365TSTFS6526	✓	69	E577	405TTGS6589	✓	81
E241A	364TTF616083	✓	59	E307	254TTFNA6030	✓	58	E456	405TSTFS6526	✓	70	E578	405TSTGS6503		81
E242	SEE E242A		59	E307-(GE)	SEE N623		108	E457	444TSTFS6526	✓	70	E580A	444TTGN16580	✓	81
E242A	365TTF616083	✓	59	E308	256TTFNA6030	✓	58	E458	445TSTFN6526	✓	70	E582A	444TTGN16532	✓	81
E243	404TTF6086	✓	59	E308-(GE)	SEE N601		108	E459	445TSTFN6528	✓	70	E583	445TTGN6597		81
E244	405TTF6086	✓	59	E309	284TTFNA6030	✓	58	E461	143TTTN6563	✓	67	E584	445TSTGN16505		81
E246	445TTFN6086	✓	60	E309-(GE)	SEE N602		108	E462	145TTTN6584		67	E585	445TTGN6542	✓	81
E247	445TTFN6038	✓	60	E310	286TTFNA6030	✓	58	E463	143TTTN6502		67	E588	445TTGN6538	✓	81
E250	5KCR46JN0083Y	✓	28	E310-(GE)	SEE N626A		108	E464	145TTTN6834	✓	67	E591	449TTGS16537	✓	81
E251	5KCR46JN0084	✓	27	E311	324TTF6030	✓	59	E465	182TTTS6578		67	E594	405TTGS6548	✓	81
E252	5KCR46JN0083X	✓	28	E311-(GE)	SEE EG311		108	E466	145TTTN6521		67	E595	449TSTGS14003		81
E253	5KCR46JN0085	✓	21	E312	326TTF6030	✓	59	E467	145TTTN6835	✓	68	E601	182TTTS6501	✓	68
E254	5KCR46JN0086X	✓	24	E312-(GE)	SEE N605		108	E468	184TTTS6582	✓	68	E602	184TTF6501	✓	68
E255	5KCR46JN0087Y	✓	32	E313	364TTF6040	✓	59	E470	182TTTS6538	✓	68	E603	213TTTS6501	✓	68
E256	5KCR46JN0088	✓	31	E314	405TTF6040	✓	59	E471	213TTF6594	✓	68	E604	215TTF6501	✓	68
E257	5KCR46JN0087X	✓	32	E315	365TTF6040	✓	59	E472	184TTF6810	✓	68	E605	254TTGN6501	✓	68
E258	5KCR46JN0089	✓	29	E316	SEE E316A		60	E473	184TTF6844	✓	68	E606	256TTFNA6501	✓	69
E259	5KCR46MN0090Y		28	E316A	444TTFN6044		60	E474	215TTF6881	✓	68	E607	284TSTFNA6501	✓	69
E260	5KCR46MN0091	✓	27	E317	445TTFN6037		60	E475	213TTTS6502	✓	68	E608	286TSTFNA6501	✓	69
E261	5KCR46MN0090X	✓	28	E319	324TSTFS6005		59	E476	213TTF6531	✓	68	E609	324TSTFS6501	✓	69
E262	5KCR46MN0092	✓	21	E320	326TSTFS6005		59	E477	254TTFNA6590	✓	68	E610	326TSTFS6501	✓	69
E263	5KCR46MN0054X	✓	24	E321	364TSTFS6005		59	E478	215TTF6807	✓	68	E611	364TSTFS6501	✓	69
E264	5KCR46MN0055Y	✓	32	E322	365TSTFS6002		59	E479	215TTF6527	✓	68	E612	365TSTFS6501	✓	69
E265	5KCR46MN0093	✓	31	E323	405TSTFS6005		59	E480	256TTFNA6596	✓	68	E613	405TSTFS6501	✓	70
E266	5KCR46MN0055X	✓	32	E324	444TSTFS16002		60	E481	254TTFNA6515	✓	68	E614	444TSTFS6501	✓	70
E267	5KCR46MN0094	✓	29	E326	445TTFN6039		60	E482	254TTFNA6529	✓	68	E615	445TSTFN6501	✓	70
E268	5KCR49PN0095Y	✓	28	E327	444TTFN16577		70	E483	284TTFNA6876	✓	68	E616	182TTTS6526	✓	68
E269	5KCR49PN0096	✓	27	E328	444TTFN6086	✓	59	E484	256TTFNA6523	✓	69	E617	184TTF6526	✓	68
E270	5KCR49PN0095X	✓	28	E342	445TSTFN16004	✓	60	E485	256TTFNA6529	✓	69	E618	213TTF6526	✓	68
E271	449TSTFS6003		60	E345	449TTF616534		70	E486	286TTFNA6876		69	E619	215TTF6526	✓	68
E271-(GE)	SEE EG271		21	E351	143TTTN6001	✓	56	E488	284TTFNA6837	✓	69	E620	254TTFNA6526	✓	68
E272	449TSTFS6002		60	E353	145TTTN6001	✓	57	E490	286TSTFNA6804	✓	69	E620-P	254TTFNA16838	✓	68
E272-(GE)	SEE EG272		24	E362	—		70	E491	286TTFNA6570	✓	69	E621	256TTFNA6526	✓	69
E273	449TSTFS6001		60	E363	5013LSTFS6595		70	E493	405TSTFS6502		70	E621-P	256TTFNA16855	✓	69
E273-(GE)	SEE EG273		32	E364	5011LSTFS16031		70	E494	444TSTFS6505		70	E622	284TTFNA6526	✓	69
E274	5KCR49PN0100	✓	31	E365	—		70	E495	445TSTFN6502		70	E622-P	284TTFNA16851	✓	69
E275	5KCR49PN0099X	✓	32	E366	5011LSTFS16033		70	E496	445TSTFN6506		70	E623	286TTFNA6526	✓	69

Index

Catalog Number/Model Number

CAT. NO.	MODEL NO.	STOCK	PAGE NO.	CAT. NO.	MODEL NO.	STOCK	PAGE NO.	CAT. NO.	MODEL NO.	STOCK	PAGE NO.	CAT. NO.	MODEL NO.	STOCK	PAGE NO.
E623-P	286TTFNA16847	✓	69	E691	449TTF6537	✓	70	E757	445TSDS4001	✓	39	E805A	365TFC6041	✓	59
E624	324TTF6526	✓	69	E692	449TTF6536	✓	70	E758	213TTDW4030		38	E806	SEE E244		59
E624-P	324TTF616860	✓	69	E694	284TTFNA6580	✓	68	E759	215TTDW4030	✓	38	E807	SEE E228		59
E625	326TTF6526	✓	69	E695	286TTFNA6580		69	E760	254TTDX4030	✓	38	E808	SEE E808A		59
E625-P	326TTF616844	✓	69	E696	324TTF6577		69	E761	256TTDX4032		38	E808A	405TSTFS16033	✓	59
E626	364TTF6536	✓	69	E697	444TTF6540		70	E762	284TTP4035		38	E809	SEE E328		59
E627	365TTF6536	✓	69	E698	449TSTFS6502	✓	70	E762A	284TTDC6029	✓	43	E810	SEE E810A		60
E628	405TTF6536	✓	70	E699	449TSTFS6503	✓	70	E763	286TTP4034		39	E810A	444TSTFN16033	✓	60
E629	444TTF6536	✓	70	E702	SEE U246		42	E763A	286TTDC6029	✓	43	E811	SEE E811A		60
E630	445TTF6536	✓	70	E704	SEE GT0012		38	E764	324TTDP4028		39	E811A	445TSTFN6026	✓	60
E631	445TTF6538	✓	70	E705	SEE U249A		43	E764A	324TTDC6029	✓	44	E812	SEE E342		60
E632	182TTTS6576	✓	67	E706	SEE U764		43	E765	326TTP4048		39	E813	SEE E813A		60
E633	184TTTS6576	✓	68	E707	SEE U766		43	E765A	326TTDC6029	✓	44	E813A	445TSTFN16033	✓	60
E634	213TTFS6576	✓	68	E708	SEE E708A		43	E766	364TTDS4040		39	E814	SEE E814A		60
E635	215TTFS6576	✓	68	E708A	254TTDX16010	✓	43	E766A	365TDS16067		44	E814A	449TTF616094	✓	60
E636	254TTFNA6576	✓	68	E709	SEE E709A		43	E767	365TDS4041		39	E815	324TTFPA4030		50
E637	256TTFNA6576	✓	68	E709A	256TTDX16006	✓	43	E767A	365TDS16064		44	E815A	SEE GT1134		62
E638	284TTFNA6576	✓	68	E710	SEE U772		43	E768	SEE E768C		44	E816	SEE E816A		59
E639	286TTFNA6576	✓	69	E711	SEE U774		44	E768C	365TSDS16042	✓	44	E816A	324TSTFC6036	✓	59
E640	324TTF6576	✓	69	E712	SEE U776		44	E769	449TSTFS6501	✓	70	E817	286TTFPA4030		50
E641	326TTF6576	✓	69	E713	SEE U778		43	E770	449TTF6530	✓	70	E817A	286TFC6031	✓	59
E642	SEE E642A		69	E714	SEE U1782		44	E771	449TTF6528	✓	70	E818	SEE E818A		58
E642A	364TTF616584	✓	69	E715	SEE U758		42	E772	449TTF6527	✓	70	E818A	286TSTFC6036	✓	58
E643	SEE E643A		69	E716	SEE U759		42	E773	449TTF6578	✓	70	E819	286TSTFPA4005		50
E643A	365TTF616591	✓	69	E717	SEE U760		42	E774	449TTF6577		70	E819A	SEE GT1130		62
E644	404TTF6586	✓	69	E718	SEE E1930		42	E776	449TTF616553		70	E820	SEE GT1029		62
E645	405TTF6586	✓	69	E719	SEE E1931		43	E777	—		70	E820A	SEE GT1029		62
E646	SEE E646A		70	E720	SEE U763		43	E780	SEE E780A		44	E821	215TTFW4005		48
E646A	444TTF616581	✓	70	E721	SEE U765		43	E780A	404TSDS16036	✓	44	E822	215TTFW4028	✓	48
E647	445TTF6586	✓	70	E722	SEE U722A		43	E781	SEE E781A		44	E823	SEE GT1005		61
E648	143TTTN6576	✓	67	E722A	254TTDX16042	✓	43	E781A	405TSDS16038	✓	44	E823A	SEE GT1005		61
E649	143TTTN6526	✓	67	E722A-P	254TTDX16043	✓	43	E782	SEE E782C		44	E824	143TTFR4028	✓	47
E650	145TTTN6576	✓	67	E723	SEE E723B		43	E782C	365TSDS16041	✓	44	E825	143TTTN4028		49
E651	143TTTN6501	✓	67	E723A	SEE E723B		43	E783	SEE E783A		37	E826	143TTTC4026	✓	49
E652	145TTTN6526	✓	67	E723B	256TTDX16032	✓	43	E783A	143TTDR6313	✓	37	E827	SEE E2126		56
E653	145TTTN6501	✓	67	E723B-P	256TTDX16033	✓	43	E784	SEE U247		42	E828	143TTTN4030		49
E654	145TTTN6527	✓	68	E725A	SEE U773		43	E785	145TTDR4078		37	E829	145TTTN4076	✓	49
E655	184TTF6505	✓	68	E725B	SEE U773		43	E786	256TTDX4013	✓	38	E830	143TTFR4003		48
E656	213TTTS6505	✓	68	E726	SEE U775		44	E787	324TTP4030	✓	39	E831	143TTTN4003		49
E657	215TTF6505	68	68	E727	SEE U777		44	E788	215TTDW4003	✓	38	E832	SEE E2103		56
E658	254TTFNA6503	68	68	E728	SEE U265		42	E789	SEE E789A		44	E833	143TTTN4001	✓	49
E659	256TTFNA6503	✓	69	E729	SEE E1729		37	E789A	326TSDP16032	✓	44	E834	SEE E2128		56
E660	284TSTFNA6502	69	69	E730	SEE U1267		42	E790	326TTP4046		39	E835	143TTTN4005		49
E662	324TSTFS6505	69	69	E731	SEE U268		42	E791	SEE E791A		44	E836	145TTFR4029	✓	48
E663	326TSTFS6502	69	69	E732	SEE U269		43	E791A	326TSDR16034	✓	44	E837	145TTTC4026	✓	49
E664	364TSTFS6505	69	69	E733	SEE E733A		43	E791A-P	326TTDR16063	✓	44	E838	145TTFR4038		48
E665	365TSTFS6502	✓	69	E733A	254TTDX16082	✓	43	E792	SEE E792A		44	E839	145TTTN4035	✓	49
E666	143TTTN6530	✓	67	E734	SEE E734A		43	E792A	444TSDS16038	✓	44	E840	145TTFR4005		48
E667	145TTTN6529	67	67	E734A	256TTDX16078	✓	43	E793	SEE E793A		43	E841	145TTTN4003		49
E668	145TTTN6530	✓	68	E735	SEE U256		43	E793A	284TSDN16031		43	E842	145TTTN4001	✓	49
E669	182TTTS6530	✓	68	E736	SEE U257		43	E794	SEE E794A		43	E843	145TTFR4007		48
E670	184TTF6530	✓	68	E737	SEE U798		43	E794A	286TSDN16036		43	E844	145TTTN4005		49
E671	213TTF6530	✓	68	E738	SEE U799		43	E795	SEE U273		44	E845	145TTFR4032	✓	48
E672	215TTF6530	✓	68	E739	SEE U1779		44	E796	SEE E796A		44	E846	145TTTC4027	✓	49
E673	254TTFNA6528	✓	68	E740	SEE U1783		44	E796A	—		44	E847	145TTFR4039		48
E674	256TTFNA6528	✓	69	E741	SEE E922		44	E797	SEE E797A		44	E848	145TTTN4040	✓	49
E675	284TTFNA6527	✓	69	E742	SEE E923		44	E797A	447TTDN16085		44	E849	SEE GT1008		61
E676	286TTFNA6527	✓	69	E743	SEE E924		44	E798	143TTDR4006		37	E849A	SEE GT1008		61
E677	324TTF6527	✓	69	E744	SEE E925		44	E798A	143TTDR16005	✓	42	E851	143TTTN6505		67
E678	326TTF6527	✓	69	E745	445TTDS4037		39	E799	SEE E1799		37	E852	145TTTN6505		67
E679	364TTF6537	✓	69	E745A	—		44	E800	284TTFPA4030		50	E853	182TTTS6505		68
E680	365TTF6537	✓	69	E746	SEE U1927		44	E800A	284TTF6031	✓	58	E854	449TTF6540	✓	70
E681	405TTF6538	✓	70	E747	SEE U1928		44	E801	SEE E801A		59	E856	449TTF6564	✓	70
E682	445TTF6537	70	70	E748	SEE U270		44	E801A	326TSTFC6036	✓	59	E901	143TTDR5348	✓	36
E683	215TTF6580	68	68	E749	SEE U271		44	E802	SEE E802A		59	E902	145TTDR5632	✓	37
E684	254TTFNA6578	68	68	E750	SEE U272		44	E802A	364TSTFC6026	✓	59	E903	145TTDR5633	✓	37
E685	256TTFNA6578	68	68	E753	SEE U1784		44	E803	SEE E243		59	E906	213TTDBA4028	✓	38
E687	449TTF6588	✓	70	E754	SEE U250		44	E804	SEE 804A		59	E907	215TTDW4028	✓	38
E688	449TTF6587	70	70	E755	SEE U251		44	E804A	365TSTFC6026	✓	59	E908	254TTDX4028	✓	38
E690	449TTF6538	✓	70	E756	SEE U252		44	E805	365TTF64040		50	E909	256TTDX4027	✓	38

Catalog Number/Model Number

CAT. NO.	MODEL NO.	STOCK	PAGE NO.	CAT. NO.	MODEL NO.	STOCK	PAGE NO.	CAT. NO.	MODEL NO.	STOCK	PAGE NO.	CAT. NO.	MODEL NO.	STOCK	PAGE NO.
E910	284TDP4029	✓	38	E981	SEE E230		60	E2004A	145TTFR16331	✓	60	E2150	056T34F16001		56
E911	286TDP4027	✓	39	E982	SEE 2105		56	E2005A	182TTFW6076	✓	60	E2151	143TTFR16038	✓	56
E912	143TDR5351		37	E983	SEE E983B		58	E2006	145TTFR3002	✓	60	E2152	145TTFR15581		56
E912A	143TDR16037	✓	42	E983B	286TFC6027	✓	58	E2007	SEE E2007A		60	E2153	143TTFR16001		56
E913	SEE E913A		42	E984	SEE GT1034		62	E2007A	145TTFR16329	✓	60	E2154	145TTFR16038	✓	56
E913A	145TDR16061	✓	42	E984B	SEE GT1034		62	E2008	184TTFW6076	✓	60	E2155	182TTFW16082		56
E914	145TDR5665		37	E985	SEE GT1040		62	E2009	182TTFW6001	✓	60	E2156	145TTFR16001		57
E914A	145TDR16062	✓	37,42	E985B	SEE GT1040	✓	62	E2010	182TTFW6026	✓	60	E2157	145TTFR16039	✓	57
E915B	182TDDW16029	✓	42	E986	SEE E215		60	E2011	213TTFW6076	✓	60	E2158	184TTFW16079		57
E916B	184TDDW16040	✓	43	E987	SEE E214		60	E2012	184TTFW6001	✓	60	E2159	182TTFW16002	✓	57
E917	143TDR4005		37	E988	SEE GT1035		62	E2013	184TTFW6026	✓	60	E2160	182TTFW16038	✓	57
E918	184TDR4178		37	E988A	SEE GT1035	✓	62	E2014	215TTFW6076	✓	60	E2161	213TTFW16082		57
E919	145TDR4003		37	E989	SEE E247		60	E2015	213TTFW6001	✓	60	E2162	184TTFW16002	✓	57
E921	365TDS6060		44	E991	SEE E991A		59	E2016	SEE E2016A		60	E2163	184TTFW16038	✓	57
E922	404TDS6060	✓	44	E991A	365STFC6003	✓	59	E2016A	213TTFW16039	✓	60	E2164	215TTFW16081		57
E923	405TDS6060	✓	44	E992	SEE E229		59	E2018	215TTFW6001	✓	60	E2201-P	143TTFN16040	✓	56
E924	444TDS6060	✓	44	E993	SEE E993A		59	E2019	215TTFW6026	✓	60	E2204-P	145TTFN16046	✓	56
E925	445TDS6060	✓	44	E993A	365TFC6087	✓	59	E2019A	215TTFN16047	✓	60	E2207-P	145TTFN16045	✓	57
E932	145TDR4105		37	E994	SEE E2106		57	E2100	056T34F15940	✓	56	E2210-P	182TTFN16047	✓	57
E932A	145TDR16010	✓	42	E995	SEE E2108		57	E2101	143TTFR15642	✓	56	EG271	5KCR49PN0097	✓	21
E933	182TDR4104		38	E996	SEE E2122		58	E2102	145TTFR16078	✓	56	EG272	5KCR49PN0098X	✓	24
E934	145TDR4080		37	E997	SEE E2147		58	E2103	143TTFR15582	✓	56	EG273	5KCR49PN0099Y	✓	32
E934A	145TDR16077	✓	42	E998	256TFL14030		48	E2104	145TTFR16033	✓	56	EG276	5KCR49PN0101	✓	29
E935	215TDDW4078	✓	38	E999	SEE E999A		58	E2105	182TTFW16076	✓	56	EG277	5KCR48UN102Y		28
E936	SEE U280		43	E999A	284STFC6036	✓	58	E2106	145TTFR13002	✓	57	EG282	5KCR49UN106Y	✓	32
E937	SEE 937A		38	E1002	284TDR16077	✓	43	E2107	145TTFR16035	✓	57	EG283	5KCR49UN1017	✓	31
E937A	184TDDW4003		38	E1006	284TDR16047	✓	43	E2108	184TTFW16076	✓	57	EG284	5KCR49UN106X	✓	32
E938	184TDR4105		38	E1006-P	284TDR16048	✓	43	E2109	182TTFW16001	✓	57	EG287	SEE N322		106
E938A	184TDDW16027	✓	43	E1008	284TSDR16003	✓	43	E2110	182TTFW16026	✓	57	EG297	SEE N647		107
E939	213TDDW4003		38	E1009	286TDR16037	✓	43	E2111	213TTFW16076	✓	57	EG302	SEE N566		108
E950	SEE E2101		56	E1009-P	286TDR16038	✓	43	E2112	184TTFW16001	✓	57	EG303	SEE N567		108
E951	SEE E2104		56	E1010	286TSDR16002	✓	44	E2113	184TTFW16026	✓	57	EG304	SEE N622		108
E952	SEE E2107		57	E1704	SEE U1248		43	E2114	215TTFW16076	✓	57	EG305	SEE N569		108
E953	SEE E2110		57	E1705	SEE U249A		43	E2115	213TTFW16001	✓	57	EG306	SEE N599		108
E954	SEE E2113		57	E1719	SEE E1931		43	E2116	213TTFW16026	✓	57	EG307	SEE N623		108
E955	SEE E2116		57	E1724	SEE U771		43	E2117	254TFL16076	✓	57	EG308	SEE N601		108
E957	SEE GT1043		62	E1726	SEE U775		44	E2118	215TTFW16001	✓	58	EG309	SEE N602		108
E957A	SEE GT1043		62	E1727	SEE U777		44	E2119	215TTFW16026	✓	58	EG310	SEE N626A		108
E958	SEE E289		60	E1729	SEE U1266		42	E2120	256TFL16076	✓	58	EG311	5KS49UN4598	✓	108
E959	SEE E213		59	E1730	SEE U1267		42	E2121	254TFL16001	✓	58	EG312	SEE N605		108
E960	SEE GT1039		62	E1739	SEE U1779		44	E2122	254TFL16026	✓	58	F10E1	5KC49TN0063Y	✓	99
E960A	SEE GT1039		62	E1740	SEE U1783		44	E2122-P	254TFL16036	✓	58	F12E1	SEE F102		99
E961C	SEE GT1028		62	E1768	SEE E768C		44	E2123	256TFL16002	✓	58	F13E1	SEE F101		99
E962	SEE GT1037		62	E1782	SEE E782C		44	E2124	256TFL16033	✓	58	F15E1	5KCR48WN0292Y		99
E962B	SEE GT1037		62	E1799	182TDDW4083	✓	37	E2124-P	256TFL16038	✓	58	F34E1	SEE F103		99
E963	SEE E2112		57	E1904	182TDDW4027	✓	38	E2125	056T34F16020		56	F100	SEE F105		99
E964	SEE GT1030		62	E1905	184TDDW4027	✓	38	E2126	143TTFR16040	✓	56	F101	056C17F5324	✓	99
E964A	SEE GT1030		62	E1915	182TDDW4030		38	E2127	145TTFR16080		56	F102	056C17F5325	✓	99
E965	SEE E2124		58	E1916	184TDDW4030	✓	38	E2128	143TTFR16020		56	F103	056C17F5326	✓	99
E966	SEE GT1032		62	E1930	182TDDW6030	✓	42	E2129	145TTFR16040	✓	56	F104	056C17F5327	✓	99
E966A	SEE GT1032		62	E1930-P	182TDDW16063	✓	42	E2130	182TTFW16080	✓	56	F105	056B17F5307	✓	99
E967	SEE E2109		57	E1931	184TDDW6031	✓	43	E2131	145TTFR16020		57	F107	SEE C1468		159
E968	SEE GT1026		61	E1931-P	184TDDW16061	✓	43	E2132	145TTFR16045	✓	57	F108	SEE C1273		159
E968A	SEE GT1026		61	E1955	SEE E2116		57	E2133	184TTFW16081		57	F109	SEE C1274		159
E969	SEE E2118		58	E1956	SEE E2119		58	E2134	182TTFW16020	✓	57	F110	SEE C1275		159
E970	SEE E2114		57	E1961	SEE E961C		58	E2135	182TTFW16040	✓	57	F120	SEE C1467		159
E971	SEE GT1033		62	E1962	SEE E962B		59	E2136	213TTFW16081		57	F131	056C17F5358	✓	32,99
E971A	SEE GT1033		62	E1963	SEE E2112		57	E2137	184TTFW16020	✓	57	F132	056C17F5912	✓	32,99
E972	SEE E2115		57	E1967	SEE E2109		57	E2138	184TTFW16040	✓	57	F133	056C17F5913	✓	32,99
E973	SEE E2120		58	E1982	SEE E2105		56	E2139	215TTFW16080		57	F134	056C17F5914	✓	32,99
E974	SEE E2123		58	E1983	SEE E983B		58	E2140	213TTFW16020		57	F135	056B17F5584	✓	32,99
E975	SEE GT1027		62	E1984	SEE E984B		59	E2141	213TTFW16040	✓	57	F201	SEE HG646		100
E975A	SEE GT1027		62	E1985	SEE E985B		59	E2142	254TFL16077		57	F202	SEE C1292		100
E976	SEE GT1036		62	E1995	SEE E2108		57	E2143	215TTFW16020		58	F203	SEE C1293		100
E976A	SEE GT1036		62	E2000	056T34F5940	✓	60	E2144	215TTFW16040	✓	58	F204	SEE C1294		100
E977	SEE E2121		58	E2001	SEE E2001A		60	E2145	256TFL16077		58	F205	SEE C1295		100
E978	SEE E978A		58	E2001A	143TTFR16053	✓	60	E2146	254TFL16020		58	F780	5KCP49UN9837S	✓	104
E978A	284TFC6077	✓	58	E2002	145TTFR6078	✓	60	E2147	254TFL16040	✓	58	F781	5KCP49UN9838S	✓	101
E979	SEE E2102		56	E2003	143TTFR5582	✓	60	E2148	256TFL16020		58	F1201	048C17F11005	✓	100
E980	SEE E2111		57	E2004	SEE E2004A		60	E2149	256TFL16040	✓	58	F1202	048C17F11006	✓	100

Index

Catalog Number/Model Number

CAT. NO.	MODEL NO.	STOCK	PAGE NO.	CAT. NO.	MODEL NO.	STOCK	PAGE NO.	CAT. NO.	MODEL NO.	STOCK	PAGE NO.	CAT. NO.	MODEL NO.	STOCK	PAGE NO.
F1203	048C17F11007	✓	100	G234	056C17D2044	✓	27	G383	SEE K166		48	G648	056T34G5303		76
F1204	056C17F15537	✓	100	G238	056C34D2101	✓	27	G385	056T34F5338		48	G649	056T17G5312	✓	76
F1205	056B17F15516	✓	100	G242	056T17D2115	✓	40	G387	056T17F5327		48	G650	056C11G5306	✓	34
G044	048T17D2000	✓	36	G243	056T17D2116	✓	40	G390	056C34F5311	✓	30,194	G651	056C17G5315	✓	34
G046	056T17D2128		36	G244	056T17D2127		40	G391	056B34F5321	✓	30	G652	056C11G5307	✓	34
G047	056T17D2095	✓	36	G245	SEE K247		40	G392	SEE G1392		30	G653	056C34G5308	✓	34
G061	056T11D5301		36	G248	SEE K1299		40	G393	056C34F5307	✓	29	G654	056C17G5316	✓	34
G062	056T17D2114	✓	36	G250	056B17D2011	✓	27	G396	056B17F5310	✓	194	G655	056B11G5301	✓	34
G063	056T17D2094	✓	36	G254	056B34D2031	✓	27	G502	SEE K253		51	G656	056C34G5309		34
G065	056T17D2112	✓	36	G256	056C17D5310	✓	27	G503	SEE K522		51	G657	056C17G5317	✓	34
G067	056T11D5302	✓	36	G258	056B34D2023		27	G507	SEE K254		51	G658	056C34G5310		34
G076	SEE C147		21	G270	056C17D5311	✓	27	G508	SEE K469		51	G659	056C17G5318	✓	34
G078	048C17D2034	✓	21	G272	056B34D5319	✓	27	G511	SEE G1511		31	G660	056T34G5304		76
G080	056T34D5301	✓	36	G274	056B17D5303	✓	27	G513	SEE G1513		31	G661	056T17G5313	✓	76
G082	056T17D2111	✓	36	G278	056C11D5304	✓	27,174	G514	056C34F5322		31	G662	056T34G5305	✓	76
G084	056T17D2093	✓	36	G289	056T34D5339		40	G515	SEE G1515		31	G663	056T17G5314	✓	76
G086	056T17D2110	✓	36	G290	056B17D5328	✓	193	G516	056C34F5323	✓	31	G664	056T17E5314	✓	76
G088	056T11D5303		36	G294	056B34D5307		193	G517	SEE G1517		31	G665	056T17E5315	✓	76
G091	048C34D2025		21	G301	SEE K321		47	G518	056C34F5324	✓	31	G666	056T17G5321	✓	76
G093	SEE C158		21	G303	SEE K154		47	G519	SEE G1519		31	G667	056T17G5322	✓	76
G094	SEE C159		21	G304	056T17F2043	✓	47	G522	SEE K255		51	G668	056T17G5323	✓	76
G095	056C17D2010	✓	21	G306	SEE K155		47	G523	SEE K523		51	G827	056T17G5310	✓	77
G096	SEE C1252		21	G308	056T34F5328	✓	47	G527	SEE K256		51	G828	056T17E5311	✓	77
G098	SEE G1098		21	G309	056T34F5333	✓	47	G528	SEE K524		51	G829	056T17G5315	✓	77
G100	056T17D2101	✓	173	G312	SEE G1312		29	G530	SEE C1424		31	G840	056T17G5316	✓	77
G101	SEE K1410		173	G314	056C17F2052	✓	29	G531	SEE G1531		31	G841	056T17G5317	✓	77
G106	056T17D2104	✓	173	G316	SEE G1316		29	G533	056B34F5319	✓	31	G842	056T17E5312		77
G107	SEE K1408		173	G321	SEE K158		47	G534	SEE C1419		31	G843	056T17E5313	✓	77
G109	SEE K381		173	G322	SEE K426		47	G541	SEE K257		51	G844	056T17G5318	✓	77
G114	SEE G1114		24,171	G324	SEE K159		47	G544	SEE K1491		51	G845	056T17G5319	✓	77
G115	SEE G1115		24,171	G326	SEE K160		47	G547	SEE K252		51	G846	056T17G5320	✓	77
G120	SEE K278		173	G327	056T34F5334	✓	47	G548	056T17F5320		51	G852	056C17E5319	✓	35
G122	056T17D5329	✓	173	G328	056T17F2045		47	G549	056T17F5329		51	G853	056C17G5320	✓	35
G126	SEE K1415		173	G329	SEE K161		47	G550	SEE C1405		32	G854	056C34G5311		35
G127	056T17D5332	✓	173	G330	SEE G1330		29	G551	SEE C375		32	G855	056C17G5321	✓	35
G128	SEE K1418		173	G331	SEE G1331		29	G552	SEE C1245		32	G857	056C17G5322	✓	35
G135	056C17D2088	✓	24,171	G332	056C17F2049	✓	29	G553	SEE C376		32	G858	056C34G5316		35
G140	056T17D5345	✓	173	G333	SEE C1333		29	G559	SEE C1420		32	G870	056C17G5323	✓	35
G141	056T17D5346	✓	173	G337	SEE C261		29	G560	SEE K1322		53	G871	056C17G5324	✓	35
G142	056T17D5347	✓	173	G338	SEE C262		29	G561	SEE K1324		53	G872	056C17G5328	✓	35
G143	056T17D5348	✓	173	G339	056C17F2051	✓	29	G562	SEE K258		53	G873	056C34G5314	✓	35
G144	056T17D5349	✓	173	G340	SEE G1340		47	G563	SEE K259		53	G874	056C17G5326	✓	35
G145	056T17D5350	✓	173	G342	SEE K162		47	G564	SEE K260		54	G875	056C34G5315		35
G151	056C17D2025	✓	24,171	G344	SEE K163		47	G565	056T17F2051		53	G876	056C17G5327	✓	35
G156	056B17D2012	✓	24,171	G345	056T34F5335		47	G569	056T34F5308		53	G905	056T17D5336	✓	36
G161	056T17D5701		173	G347	056T17F5302	✓	47	G570	056C17F5320	✓	33	G908	056T17D5339	✓	36
G162	056T17D2121	✓	173	G348	SEE K424		47	G571	056C17F5321	✓	33	G910	SEE C167		21
G165	SEE K544		173	G350	SEE C264		29	G572	056C17F5322	✓	33	G911	SEE C168		21
G166	SEE K546		173	G352	056C34F5308	✓	29	G573	056C17F5323	✓	33	G912	SEE C169		21,183
G167	SEE K1409		173	G354	SEE C268		29	G574	056B17F5305	✓	33	G913	SEE C1263		21
G168	SEE K279		173	G355	SEE C269		29	G575	056B17F5306	✓	33	G915	056C34D2100	✓	21
G169	SEE K280		173	G356	056C17F5308	✓	29	G576	056C11F5303	✓	33	G917	SEE C175		21
G180	SEE K1411		173	G357	SEE C271		29	G577	056C11F5302	✓	33	G918	SEE C176		21
G181	SEE K518		173	G359	056C34F5310	✓	30	G578	056B11F5303	✓	33	G919	056B17D2010	✓	21
G182	SEE K519		173	G360	SEE K165		47	G579	056B11F5302	✓	33	G921	056T17D5342	✓	36
G183	SEE K1413		173	G363	056T34F5336		48	G580	056T17F5305	✓	53	G923	056T17D5344	✓	37
G184	SEE K520		173	G365	SEE K167		48	G581	056T17F5321	✓	53	G930	SEE C178		21
G185	SEE K549		173	G368	056T34F5337		48	G582	056T17F5322	✓	53	G932	SEE C179		21
G186	SEE K1416		173	G369	SEE K1492		48	G583	056T17F5323	✓	53	G934	SEE C181		21
G201	SEE K248		40	G371	SEE C275		30	G584	056T17F5324	✓	54	G935	SEE C182		21
G203	SEE K249		40	G372	SEE C276		30	G585	056T17F5325	✓	54	G936	SEE C1480		21,187,193
G205	056T34D5327		40	G373	056C17F5311	✓	30,194	G586	056T11F5311	✓	53	G937	056B34D2026	✓	22
G207	SEE K250		40	G374	056B34F5320	✓	30	G587	056T11F5310	✓	53	G939	SEE C185		22
G212	056C17D2084	✓	27	G376	SEE G1376		30	G588	056T11F5309	✓	53	G950	SEE C186		22
G216	056C34D2117	✓	27	G377	SEE G1377		30	G589	056T11F5308	✓	53	G951	056C17D5308	✓	22,187
G221	SEE K251		40	G378	056B17F5302	✓	30,194	G590	056T17F5355	✓	54	G952	SEE C187		22
G225	SEE K521		40	G379	056C34F5309	✓	29,194	G591	056T17F5356	✓	54	G958	056B17D5323	✓	193
G229	SEE K644		40	G380	056C17F5957		194	G639	056C17E5314	✓	34	G961	056T17D2118	✓	173
G230	056C17D2085	✓	27	G381	056C17F5955	✓	194	G646	056T17E5308	✓	76	G962	056T17D2119	✓	173
G232	056C34D2108	✓	27	G382	056C17F5956	✓	194	G647	056T17E5309	✓	76	G963	056T17D2120	✓	173

Catalog Number/Model Number

CAT. NO.	MODEL NO.	STOCK	PAGE NO.	CAT. NO.	MODEL NO.	STOCK	PAGE NO.	CAT. NO.	MODEL NO.	STOCK	PAGE NO.	CAT. NO.	MODEL NO.	STOCK	PAGE NO.
G964	056T17D2117		173	GT0053	447TTDC16077	✓	46	GT0531	286TTDCA6033	✓	130	GT1121	254TTFCA6005	✓	61
G965	056T17D5357		173	GT0054	444TSTDC16003	✓	46	GT0532	326TTDCA6092	✓	130	GT1122	254TTFCA6030	✓	61
G966	SEE K277		173	GT0055	445TTDC6060	✓	46	GT0533	286TTDCA6008	✓	130	GT1123	284TTFCA6080	✓	61
G967	056T17D5385		173	GT0056	449TTDC16076	✓	46	GT0534	324TTDCA6033	✓	130	GT1124	256TTFCA6005	✓	61
G976	056B34D5304		193	GT0401	143TTDR6030	✓	128	GT0536	324TTDCA6008	✓	130	GT1125	256TTFCA6030	✓	61
G979	056B17D5319		193	GT0402		✓	128	GT0537	326TTDCA6033	✓	130	GT1126	286TTFCA6080	✓	61
G987	056B34D2021		193	GT0403	143TTDR6007	✓	128	GT1005	182TTFC6076	✓	61	GT1127	284TTSTFCA6005	✓	62
G996	056B34D5334		193	GT0404	145TTDR6034	✓	128	GT1008	184TTFC6076	✓	61	GT1128	284TTFCA6030	✓	62
G1098	5KC36JN266	✓	21	GT0405	182TTDB6082	✓	128	GT1009	182TTFC6001	✓	61	GT1129	324TTFCA6080	✓	62
G1114	5KC35JN7	✓	24,171	GT0406	145TTDR6007	✓	128	GT1010	182TTFC6026	✓	61	GT1130	286TTSTFCA6005	✓	62
G1115	5KC35JN7X	✓	24,171	GT0407	145TTDR6036	✓	128	GT1011	213TTFC6076	✓	61	GT1131	286TTFCA6030	✓	62
G1312	5KC32GN19	✓	29	GT0408	184TTDB6082	✓	128	GT1012	184TTFC6001	✓	61	GT1132	326TTFCA6080	✓	62
G1316	5KC49MN6061	✓	29	GT0409	145TTDR6013	✓	129	GT1013	184TTFC6026	✓	61	GT1133	324TTSTFCA6005	✓	62
G1330	5KC35MN43	✓	29	GT0410	182TTDB6032	✓	129	GT1014	215TTFC6076	✓	61	GT1134	324TTFCA6030	✓	62
G1331	5KC35MN43X	✓	29	GT0411	213TTDB6082	✓	129	GT1015	213TTFC6001	✓	61	GT1135	364TTFCA6080	✓	62
G1340	5K36PN251	✓	47	GT0412	182TTDB6007	✓	129	GT1016	213TTFC6026	✓	61	GT1136	326TTSTFCA6005	✓	62
G1376	5KCR48WN0273	✓	30	GT0413	184TTDB6032	✓	129	GT1017	254TTFCA6076	✓	61	GT1137	326TTFCA6030	✓	62
G1377	5KCR48WN0273X	✓	30	GT0414	215TTDB6082	✓	129	GT1018	215TTFC6001	✓	61	GT1138	365TTFCA6080	✓	62
G1392	5KCR49TN2139U	✓	30	GT0415	184TTDB6007	✓	129	GT1019	215TTFC6026	✓	61	GT1139	364TTSTFCA6005	✓	62
G1511	5KC32GN25	✓	31	GT0416	213TTDB6032	✓	129	GT1020	256TTFCA6076	✓	61	GT1140	364TTFCA6040	✓	62
G1513	5KC35MN73	✓	31	GT0417	254TTDCA6082	✓	129	GT1021	254TTFCA6001	✓	61	GT1141	404TTFC6080	✓	62
G1515	5KC42GN0018	✓	31	GT0418	213TTDB6007	✓	129	GT1022	254TTFCA6026	✓	61	GT1142	365TTSTFCA6002	✓	62
G1517	5KC46PN0032	✓	31	GT0419	215TTDB6032	✓	129	GT1023	284TTFCA6076	✓	61	GT1143	365TTFCA6040	✓	62
G1519	5KC49TN0035	✓	31	GT0420	256TTDCA6082	✓	129	GT1024	256TTFCA6001	✓	61	GT1144	405TTFC6080	✓	62
G1531	5KCR48WN0294	✓	31	GT0421	215TTDB6007	✓	129	GT1025	256TTFCA6026	✓	61	GT1145	405TTSTFCA6005	✓	62
GT0005	182TTDB6076	✓	45	GT0422	254TTDCA6032	✓	129	GT1026	286TTFCA6076	✓	61	GT1146	405TTFC6040	✓	62
GT0008	184TTDB6076	✓	45	GT0423	284TTDCA6082	✓	129	GT1027	284TTSTFCA6001	✓	62	GT1147	444TTFC6080	✓	62
GT0010	182TTDB6026	✓	45	GT0424	254TTDCA6007	✓	129	GT1028	284TTFCA6026	✓	62	GT1148	444TTSTFC16002	✓	62
GT0011	213TTDB6076	✓	45	GT0425	256TTDCA6032	✓	129	GT1029	324TTFCA6076	✓	62	GT1149	444TTFC6044	✓	62
GT0012	182TTDB6001	✓	45	GT0426	286TTDCA6082	✓	129	GT1030	286TTSTFCA6001	✓	62	GT1150	445TTFC6080	✓	62
GT0013	184TTDB6026	✓	45	GT0427	256TTDCA6007	✓	129	GT1031	286TTFCA6026	✓	62	GT1151	445TTSTFCA6005	✓	63
GT0014	215TTDB6076	✓	45	GT0428	284TTDCA6032	✓	129	GT1032	326TTFCA6076	✓	62	GT1152	445TTFC6037	✓	63
GT0015	184TTDB6001	✓	45	GT0429	324TTDCA6082	✓	129	GT1033	324TTSTFCA6001	✓	62	GT1153	447TTFC6080	✓	63
GT0016	213TTDB6026	✓	45	GT0430	284TTDCA6007	✓	130	GT1034	324TTFCA6026	✓	62	GT1154	447TTSTFCA6005	✓	63
GT0017	254TTDCA6076	✓	45	GT0431	286TTDCA6032	✓	130	GT1035	364TTFCA6086	✓	62	GT1155	447TTFC6039	✓	63
GT0018	213TTDB6001	✓	45	GT0432	326TTDCA6082	✓	130	GT1036	326TTSTFCA6001	✓	62	GT1156	449TTFC6080	✓	63
GT0019	215TTDB6026	✓	45	GT0433	286TTDCA6007	✓	130	GT1037	326TTFCA6026	✓	62	GT1201	143TTFR6032	✓	63
GT0020	256TTDCA6076	✓	45	GT0434	324TTDCA6032	✓	130	GT1038	365TTFCA6086	✓	62	GT1202	145TTFR16079	✓	63
GT0021	215TTDB6001	✓	45	GT0436	324TTDCA6007	✓	130	GT1039	364TTSTFCA6001	✓	62	GT1203	143TTFR6010	✓	63
GT0022	254TTDCA6026	✓	45	GT0437	326TTDCA6032	✓	130	GT1040	364TTFCA6036	✓	62	GT1204	145TTFR6058	✓	63
GT0023	284TTDCA6076	✓	45	GT0501	143TTDR6031	✓	128	GT1041	404TTFC6086	✓	62	GT1205	182TTFR6078	✓	63
GT0024	254TTDCA6001	✓	45	GT0502		✓	128	GT1042	365TTSTFCA6001	✓	62	GT1206	145TTFR6009	✓	63
GT0025	256TTDCA6026	✓	45	GT0503	143TTDR6008	✓	128	GT1043	365TTFCA6036	✓	62	GT1207	145TTFR6040	✓	63
GT0026	286TTDCA6076	✓	45	GT0504	145TTDR6031	✓	128	GT1044	405TTFC6086	✓	62	GT1208	184TTFR6078	✓	63
GT0027	256TTDCA6001	✓	45	GT0505	182TTDB6092	✓	128	GT1045	405TTSTFCA6001	✓	62	GT1209	182TTFR6003	✓	64
GT0028	284TTDCA6026	✓	45	GT0506	145TTDR6004	✓	128	GT1046	405TTFC6036	✓	62	GT1210	182TTFR6028	✓	64
GT0029	324TTDCA6076	✓	45	GT0507	145TTDR6030	✓	128	GT1047	444TTFC6086	✓	62	GT1211	213TTFBA6078	✓	64
GT0030	284TTSTDCA6001	✓	45	GT0508	184TTDB6092	✓	128	GT1048	444TTSTFCA6001	✓	62	GT1212	184TTFR6003	✓	64
GT0031	286TTDCA6026	✓	45	GT0509	145TTDR6006	✓	129	GT1049	444TTFC6036	✓	62	GT1213	184TTFR6028	✓	64
GT0032	326TTDCA6076	✓	45	GT0510	182TTDB6033	✓	129	GT1050	445TTFC6086	✓	62	GT1214	215TTFBA6078	✓	64
GT0033	286TTSTDCA6001	✓	45	GT0511	213TTDB6092	✓	129	GT1051	445TTSTFCA6001	✓	63	GT1215	213TTFBA6003	✓	64
GT0034	324TTDCA6026	✓	45	GT0512	182TTDB6008	✓	129	GT1052	445TTFC6036	✓	63	GT1216	213TTFBA6028	✓	64
GT0035	364TTDCB6086	✓	45	GT0513	184TTDB6033	✓	129	GT1053	447TTFC6087	✓	63	GT1217	254TTFCA6078	✓	64
GT0036	324TTSTDCA6001	✓	45	GT0514	215TTDB6092	✓	129	GT1054	447TTSTFCA6004	✓	63	GT1218	215TTFBA6003	✓	64
GT0037	326TTDCA6026	✓	45	GT0515	184TTDB6008	✓	129	GT1055	447TTFC6038	✓	63	GT1219	215TTFBA6028	✓	64
GT0038	365TTDCB6086	✓	45	GT0516	213TTDB6033	✓	129	GT1056	449TTFC6088	✓	63	GT1220	256TTFCA6078	✓	64
GT0039	326TTSTDCA6001	✓	45	GT0517	254TTDCA6092	✓	129	GT1105	182TTFC6080	✓	61	GT1221	254TTFCA6003	✓	64
GT0040	364TTDCB6060	✓	45	GT0518	213TTDB6008	✓	129	GT1108	184TTFC6080	✓	61	GT1222	254TTFCA6028	✓	64
GT0041	404TTDCB6086	✓	45	GT0519	215TTDB6033	✓	129	GT1109	182TTFC6005	✓	61	GT1224	256TTFCA6003	✓	64
GT0042	364TTSTDCB6001	✓	46	GT0520	256TTDCA6092	✓	129	GT1110	182TTFC6030	✓	61	GT1225	256TTFCA6028	✓	64
GT0043	365TTDCB6060	✓	46	GT0521	215TTDB6008	✓	129	GT1111	213TTFC6080	✓	61	GT1227	284TTSTFCA6003	✓	64
GT0044	405TTDC16081	✓	46	GT0522	254TTDCA6033	✓	129	GT1112	184TTFC6005	✓	61	GT1228	284TTFCA6028	✓	64
GT0045	365TTSTDCB6001	✓	46	GT0523	284TTDCA6092	✓	129	GT1113	184TTFC6030	✓	61	GT1230	286TTSTFCA6003	✓	64
GT0046	404TTDC6060	✓	46	GT0524	254TTDCA6008	✓	129	GT1114	215TTFC6080	✓	61	GT1231	286TTFCA6028	✓	64
GT0047	444TTDC16077	✓	46	GT0525	256TTDCA6033	✓	129	GT1115	213TTFC6005	✓	61	GT1233	324TTSTFCA6003	✓	64
GT0048	404TTSTDC6001	✓	46	GT0526	286TTDCA6092	✓	129	GT1116	213TTFC6030	✓	61	GT1234	324TTFCA6028	✓	64
GT0049	405TTDC6060	✓	46	GT0527	256TTDCA6008	✓	129	GT1117	254TTFCA6080	✓	61	GT1236	326TTSTFCA6003	✓	64
GT0050	445TTDC16076	✓	46	GT0528	284TTDCA6033	✓	129	GT1118	215TTFC6005	✓	61	GT1237	326TTFCA6028	✓	64
GT0051	405TTSTDC6007	✓	46	GT0529	324TTDCA6092	✓	129	GT1119	215TTFC6030	✓	61	GT1239	364TTSTFCA6003	✓	64
GT0052	444TTDC6060	✓	46	GT0530	284TTDCA6008	✓	130	GT1120	256TTFCA6080	✓	61	GT1240	364TTFCA6038	✓	64

Index

Catalog Number/Model Number

CAT. NO.	MODEL NO.	STOCK	PAGE NO.	CAT. NO.	MODEL NO.	STOCK	PAGE NO.	CAT. NO.	MODEL NO.	STOCK	PAGE NO.	CAT. NO.	MODEL NO.	STOCK	PAGE NO.
GT1242	365STFCA6003	✓	64	GT2428	284TTDCA6037	✓	139	GT3121	254TTFCA6006	✓	134	GT3414	215TTFB6085	✓	141
GT1243	365TTFCA6038	✓	64	GT2429	324TTDCA6085	✓	139	GT3122	254TTFCA6031	✓	134	GT3415	213TTFB6012	✓	141
GT1245	405STFCA6003	✓	64	GT2430	284TTDCA6012	✓	140	GT3123	284TTFCA6082	✓	134	GT3416	213TTFB6037	✓	141
GT1246	405TTFCA6038	✓	64	GT2431	286TTDCA6037	✓	140	GT3124	256TTFCA6006	✓	134	GT3417	254TTFCA6085	✓	141
GT1305	182TTFB6079	✓	63	GT2432	326TTDCA6085	✓	140	GT3125	256TTFCA6031	✓	134	GT3418	215TTFB6012	✓	142
GT1308	184TTFB6079	✓	63	GT2433	286TTDCA6012	✓	140	GT3126	286TTFCA6082	✓	134	GT3419	215TTFB6037	✓	142
GT1309	182TTFB6004	✓	63	GT2434	324TTDCA6037	✓	140	GT3127	284TTFCA6006	✓	134	GT3420	256TTFCA6085	✓	142
GT1310	182TTFB6029	✓	63	GT2436	324TTDCA6012	✓	140	GT3128	284TTFCA6032	✓	134	GT3421	254TTFCA6012	✓	142
GT1311	213TTFBA6079	✓	63	GT2437	326TTDCA6037	✓	140	GT3129	324TTFCA6082	✓	134	GT3422	254TTFCA6037	✓	142
GT1312	184TTFB6004	✓	63	GT2501	143TTDR16040	✓	138	GT3130	286TTFCA6006	✓	134	GT3423	284TTFCA6085	✓	142
GT1313	184TTFB6029	✓	63	GT2502		✓	138	GT3131	286TTFCA6032	✓	134	GT3424	256TTFCA6012	✓	142
GT1314	215TTFBA6079	✓	63	GT2503	143TTDR16006	✓	138	GT3132	326TTFCA6082	✓	134	GT3425	256TTFCA6037	✓	142
GT1315	213TTFBA6004	✓	63	GT2504	145TTDR16327	✓	138	GT3133	324TTFCA6007	✓	134	GT3426	286TTFCA6085	✓	142
GT1316	213TTFBA6029	✓	63	GT2505	182TTDB6095	✓	138	GT3134	324TTFCA6031	✓	134	GT3427	284TTFCA6012	✓	142
GT1318	215TTFBA6004	✓	63	GT2506	145TTDR16017	✓	138	GT3136	326TTFCA6007	✓	134	GT3428	284TTFCA6037	✓	142
GT1319	215TTFBA6029	✓	63	GT2507	145TTDR16339	✓	138	GT3137	326TTFCA6031	✓	134	GT3429	324TTFCA6085	✓	142
GT1401	143TTFR16039	✓	63	GT2508	184TTDB6095	✓	138	GT3201	143TTFR16046	✓	132	GT3430	286TTFCA6012	✓	142
GT1403	143TTFR16003	✓	63	GT2509	145TTDR16303	✓	139	GT3202		✓	132	GT3431	286TTFCA6037	✓	142
GT1404	145TTFR16046	✓	63	GT2510	182TTDB6038	✓	139	GT3203	143TTFR16013	✓	133	GT3432	326TTFCA6085	✓	142
GT1406	145TTFR16005	✓	63	GT2511	213TTDB6095	✓	139	GT3204	145TTFR16063	✓	133	GT3433	324TTFCA6012	✓	142
GT1407	145TTFR16047	✓	63	GT2512	182TTDB6013	✓	139	GT3205	182TTFB6092	✓	133	GT3434	324TTFCA6037	✓	142
GT1409	182TTFB6007	✓	64	GT2513	184TTDB6038	✓	139	GT3206	145TTFR16018	✓	133	GT3436	326TTFCA6012	✓	142
GT1410	182TTFB6032	✓	64	GT2514	215TTDB6095	✓	139	GT3207	145TTFR16071	✓	133	GT3437	326TTFCA6037	✓	142
GT1412	184TTFB6007	✓	64	GT2515	184TTDB6013	✓	139	GT3208	184TTFB6092	✓	133	GT3501	143TTFR16044	✓	140
GT1413	184TTFB6032	✓	64	GT2516	213TTDB6038	✓	139	GT3209	182TTFB6008	✓	133	GT3502		✓	140
GT1415	213TTFBA6007	✓	64	GT2517	254TTDCA6095	✓	139	GT3210	182TTFB6033	✓	133	GT3503	143TTFR16015	✓	141
GT1416	213TTFBA6032	✓	64	GT2518	213TTDB6013	✓	139	GT3211	213TTFB6092	✓	133	GT3504	145TTFR16064	✓	141
GT1418	215TTFBA6007	✓	64	GT2519	215TTDB6038	✓	139	GT3212	184TTFB6008	✓	133	GT3505	182TTFB6095	✓	141
GT1419	215TTFBA6032	✓	64	GT2520	256TTDCA6095	✓	139	GT3213	184TTFB6033	✓	133	GT3506	145TTFR16021	✓	141
GT1421	254TTFCA6007	✓	64	GT2521	215TTDB6013	✓	139	GT3214	215TTFB6092	✓	133	GT3507	145TTFR16072	✓	141
GT1422	254TTFCA6032	✓	64	GT2522	254TTDCA6038	✓	139	GT3215	213TTFB6008	✓	133	GT3508	184TTFB6095	✓	141
GT2001	143TTDR16043	✓	128	GT2523	284TTDCA6095	✓	139	GT3216	213TTFB6033	✓	133	GT3509	182TTFB6013	✓	141
GT2003	143TTDR16009	✓	128	GT2524	254TTDCA6013	✓	139	GT3217	254TTFCA6092	✓	133	GT3510	182TTFB6038	✓	141
GT2004	145TTDR16074	✓	128	GT2525	256TTDCA6038	✓	139	GT3218	215TTFB6008	✓	133	GT3511	213TTFB6095	✓	141
GT2006	145TTDR16015	✓	128	GT2526	286TTDCA6095	✓	139	GT3219	215TTFB6033	✓	133	GT3512	184TTFB6013	✓	141
GT2007	145TTDR16335	✓	128	GT2527	256TTDCA6013	✓	139	GT3220	256TTFCA6092	✓	133	GT3513	184TTFB6038	✓	141
GT2009	145TTDR16023	✓	129	GT2528	284TTDCA6038	✓	139	GT3221	254TTFCA6008	✓	134	GT3514	215TTFB6095	✓	141
GT2301	143TTDR16044	✓	138	GT2529	324TTDCA6095	✓	139	GT3222	254TTFCA6033	✓	134	GT3515	213TTFB6013	✓	141
GT2303	143TTDR16010	✓	138	GT2530	284TTDCA6013	✓	140	GT3223	284TTFCA6092	✓	134	GT3516	213TTFB6038	✓	141
GT2304	145TTDR16075	✓	138	GT2531	286TTDCA6038	✓	140	GT3224	256TTFCA6008	✓	134	GT3517	254TTFCA6095	✓	141
GT2306	145TTDR16014	✓	138	GT2532	326TTDCA6095	✓	140	GT3225	256TTFCA6033	✓	134	GT3518	215TTFB6013	✓	142
GT2307	145TTDR16337	✓	138	GT2533	286TTDCA6013	✓	140	GT3226	286TTFCA6092	✓	134	GT3519	215TTFB6038	✓	142
GT2309	145TTDR16024	✓	139	GT2534	324TTDCA6038	✓	140	GT3227	284TTFCA6008	✓	134	GT3520	256TTFCA6095	✓	142
GT2401	143TTDR16048	✓	138	GT2536	324TTDCA6013	✓	140	GT3228	284TTFCA6033	✓	134	GT3521	254TTFCA6013	✓	142
GT2402	✓	138	138	GT2537	326TTDCA6038	✓	140	GT3229	324TTFCA6092	✓	134	GT3522	254TTFCA6038	✓	142
GT2403	143TTDR16015	✓	138	GT3001	143TTFR16047	✓	132	GT3230	286TTFCA6008	✓	134	GT3523	284TTFCA6095	✓	142
GT2404	145TTDR16330	✓	138	GT3003	143TTFR16007	✓	133	GT3231	286TTFCA6033	✓	134	GT3524	256TTFCA6013	✓	142
GT2405	182TTDB6085	✓	138	GT3004	145TTFR16059	✓	133	GT3232	326TTFCA6092	✓	134	GT3525	256TTFCA6038	✓	142
GT2406	145TTDR16020	✓	138	GT3006	145TTFR16010	✓	133	GT3233	324TTFCA6008	✓	134	GT3526	286TTFCA6038	✓	142
GT2407	145TTDR16333	✓	138	GT3007	145TTFR16067	✓	133	GT3234	324TTFCA6033	✓	134	GT3527	284TTFCA6013	✓	142
GT2408	184TTDB6085	✓	138	GT3101	143TTFR16032	✓	132	GT3236	326TTFCA6008	✓	134	GT3528	284TTFCA6038	✓	142
GT2409	145TTDR16301	✓	139	GT3102		✓	132	GT3237	326TTFCA6033	✓	134	GT3529	324TTFCA6095	✓	142
GT2410	182TTDB6037	✓	139	GT3103	143TTFR16010	✓	133	GT3301	143TTFR16049	✓	140	GT3530	286TTFCA6013	✓	142
GT2411	213TTDB6085	✓	139	GT3104	145TTFR16036	✓	133	GT3303	143TTFR16009	✓	141	GT3531	286TTFCA6038	✓	142
GT2412	182TTDB6012	✓	139	GT3105	182TTFB6082	✓	133	GT3304	145TTFR16060	✓	141	GT3532	326TTFCA6095	✓	142
GT2413	184TTDB6037	✓	139	GT3106	145TTFR16013	✓	133	GT3306	145TTFR16016	✓	141	GT3533	324TTFCA6013	✓	142
GT2414	215TTDB6085	✓	139	GT3107	145TTFR16037	✓	133	GT3307	145TTFR16068	✓	141	GT3534	324TTFCA6038	✓	142
GT2415	184TTDB6012	✓	139	GT3108	184TTFB6082	✓	133	GT3401	143TTFR16051	✓	140	GT3536	326TTFCA6013	✓	142
GT2416	213TTDB6037	✓	139	GT3109	182TTFB6006	✓	133	GT3402		✓	140	GT3537	326TTFCA6038	✓	142
GT2417	254TTDCA6085	✓	139	GT3110	182TTFB6031	✓	133	GT3403	143TTFR16011	✓	141	GT4001	143TTDR16042	✓	128
GT2418	213TTDB6012	✓	139	GT3111	213TTFB6082	✓	133	GT3404	145TTFR16326	✓	141	GT4003	143TTDR16012	✓	128
GT2419	215TTDB6037	✓	139	GT3112	184TTFB6006	✓	133	GT3405	182TTFB6085	✓	141	GT4004	145TTDR16073	✓	128
GT2420	256TTDCA6085	✓	139	GT3113	184TTFB6031	✓	133	GT3406	145TTFR16014	✓	141	GT4006	145TTDR16013	✓	128
GT2421	215TTDB6012	✓	139	GT3114	215TTFB6082	✓	133	GT3407	145TTFR16056	✓	141	GT4007	145TTDR16336	✓	128
GT2422	254TTDCA6037	✓	139	GT3115	213TTFB6006	✓	133	GT3408	184TTFB6085	✓	141	GT4009	145TTDR16022	✓	129
GT2423	284TTDCA6085	✓	139	GT3116	213TTFB6031	✓	133	GT3409	182TTFB6012	✓	141	GT4101	143TTDR16047	✓	128
GT2424	254TTDCA6012	✓	139	GT3117	254TTFCA6082	✓	133	GT3410	182TTFB6037	✓	141	GT4103	143TTDR16013	✓	128
GT2425	256TTDCA6037	✓	139	GT3118	215TTFB6006	✓	133	GT3411	213TTFB6085	✓	141	GT4104	145TTDR16329	✓	128
GT2426	286TTDCA6085	✓	139	GT3119	215TTFB6031	✓	133	GT3412	184TTFB6012	✓	141	GT4106	145TTDR16019	✓	128
GT2427	256TTDCA6012	✓	139	GT3120	256TTFCA6082	✓	133	GT3413	184TTFB6037	✓	141	GT4107	145TTDR16332	✓	128

CAT. NO.	MODEL NO.	STOCK	PAGE NO.	CAT. NO.	MODEL NO.	STOCK	PAGE NO.	CAT. NO.	MODEL NO.	STOCK	PAGE NO.	CAT. NO.	MODEL NO.	STOCK	PAGE NO.
GT4109	145TTDR16305	✓	129	H137	5KH49MN6057S	✓	102	H207	5KH46MN3041	✓	174	H621-(GE)	SEE HG621		170
GT4201	143TTDR16039	✓	128	H138-(GE)	SEE HG138		102	H208	5KH32DN111	✓	174	H622	SEE E908		38
GT4203	143TTDR16007	✓	128	H139	5KH33JN3121S	✓	102	H209	5KH37PN36	✓	174	H623	SEE U646A		48
GT4204	143TTDR16046	✓	128	H140-(GE)	SEE HG140		102	H210	5KH37PN36X	✓	174	H625	SEE E909		37
GT4206	145TTDR16018	✓	128	H141-(GE)	SEE HG141		102	H212	5KH33FN77	✓	174	H627	SEE E786		38
GT4207	145TTDR16338	✓	128	H142-(GE)	SEE HG142		102	H213	5KH33FN77X	✓	174	H628	SEE E910		38
GT4209	145TTDR16302	✓	129	H143-(GE)	SEE HG143		102	H214	5KH46MN6071	✓	174	H631	SEE U901		39
GT4301	143TTDR16045	✓	138	H150	143TTDR5376	✓	36	H215	5KH46MN6071X	✓	174	H632	SEE E911		39
GT4303	143TTDR16011	✓	138	H152-(GE)	SEE HG152		169	H217	5KH35JN121	✓	174	H636	SEE E787		39
GT4304	145TTDR16326	✓	138	H154-(GE)	SEE HG154		169	H218	5KH35JN121X	✓	174	H641	5KH39CN5501X	✓	119
GT4306	145TTDR16307	✓	138	H155-(GE)	SEE HG155		169	H219	5KH49PN6069	✓	174	H642	5KH39CN5504X	✓	119
GT4307	145TTDR16342	✓	138	H156-(GE)	SEE HG156		169	H221	5KH48UN6074	✓	174	H645	5KH39QN8810	✓	25
GT4309	145TTDR16025	✓	139	H157	5KH32DN3085X	✓	169	H222	5KH49PN3047	✓	174	H646-(GE)	SEE HG646		100
GT4401	143TTDR16049	✓	138	H158	5KH37PN41	✓	169	H223	5KH37PN40	✓	174	H647	5KHC39QN9584X	✓	102
GT4403	143TTDR16014	✓	138	H159	5KH37PN41X	✓	169	H224	5KH49SN3049	✓	174	H648-(GE)	SEE HG648		102
GT4404	145TTDR16331	✓	138	H160	5KH32FN3083	✓	169	H225	5KH46MN3040	✓	174	H649	5KHC39QN9575T	✓	102
GT4406	145TTDR16021	✓	138	H161-(GE)	SEE HG161		169	H226	5KH49PN3042	✓	174	H664	SEE E824		47
GT4407	145TTDR16334	✓	138	H162	5KH46MN6053	✓	169	H229	5KH35HN9	✓	23	H665	SEE E836		48
GT4409	145TTDR16306	✓	139	H163	5KH46MN6053X	✓	169	H230	5KH39QN9091		23	H666	SEE E845		48
GT4501	143TTDR16041	✓	138	H164	5KH32JN3128	✓	170	H233	5KH36PN109	✓	172	H668	SEE H1668		48
GT4503	143TTDR16008	✓	138	H165	5KH32JN3128X	✓	170	H234	5KH39QN9105X	✓	172	H669	SEE U627		48
GT4504	145TTDR16328	✓	138	H166	5KH35JN26	✓	170	H236	5KH35MN56X	✓	172	H670	SEE E822		48
GT4506	145TTDR16016	✓	138	H167	5KH35JN26X	✓	170	H239	5KH33FN6	✓	21	H673	5KH33KN5594	✓	26
GT4507	145TTDR16340	✓	138	H168	5KH49PN6055	✓	170	H243	5KH32GN68X	✓	29	H674	5KH35JNA231	✓	26
GT4509	145TTDR16304	✓	139	H169	5KH36KN114	✓	169	H244	5KH32EN124	✓	31	H675	5KH33FNA230	✓	25
GT5001	143TFR16048	✓	132	H170	5KH36KN114X	✓	169	H247	5KH42JN0328S	✓	102	H676	5KH35GNA229	✓	23
GT5003	143TFR16005	✓	133	H171	5KH37PN33	✓	169	H248	5KH36MN3106X	✓	170	H679	SEE E1799		37
GT5004	145TFR16058	✓	133	H172	5KH37PN33X	✓	169	H274	SEE U651		48	H679-(GE)	SEE HG679		119
GT5006	145TFR16009	✓	133	H173	5KH46MN3025	✓	170	H275	5KH49PN3045	✓	170	H680-(GE)	SEE HG680		119
GT5007	145TFR16066	✓	133	H174	5KH46MN3025X	✓	170	H276	5KH42JN0328	✓	102	H681-(GE)	SEE HG681		119
GT5101	143TFR16052	✓	132	H175	5KH49PN3026	✓	170	H277	5KH33KN20S	✓	102	H682	5KH32ENA443X	✓	119
GT5103	143TFR16006	✓	133	H176	5KH49PN3026X	✓	170	H278	5KH37PN37X	✓	174	H683	5KH33GNA444X	✓	119
GT5104	145TFR16074	✓	133	H178	447TSTDN7001	✓	39,145	H280	5KH49UN3024X	✓	174	H684	5KH36MNA445X	✓	119
GT5106	145TFR16012	✓	133	H178-(GE)	SEE HG178		172	H282	5KH49PN3042X	✓	174	H685	5KH39EN2887X	✓	120
GT5107	145TFR16057	✓	133	H180	143TTDR5401		36	H286	5KH36MN3106	✓	170	H689	5KH35JN603X	✓	23
GT5201	143TFR16042	✓	132	H181	145TTDR5401	✓	36	H287	5KH36KN112X	✓	174	H690-(GE)	SEE HG690		25
GT5203	143TFR16004	✓	133	H181-(GE)	SEE B1502		172	H288	5KH49SN3023X	✓	174	H691	5KH36LN488X	✓	23
GT5204	145TFR16062	✓	133	H182A	182TTDW7101		37	H290	5KH36MN137	✓	174	H692-(GE)	SEE HG692		26
GT5206	145TFR16017	✓	133	H182-(GE)	SEE HG182		172	H291	5KH32EN72X	✓	172	H693	5KH46JN0329X	✓	26
GT5207	145TFR16070	✓	133	H183A	184TTDW7101		37	H293	5KH46PN3034	✓	172	H694-(GE)	SEE HG694		170
GT5301	143TFR16050	✓	140	H184	SEE H184A		37	H296	5KH49SN3046	✓	169	H695-(GE)	SEE HG695		169
GT5303	143TFR16008	✓	141	H184A	213TTDW14102		37	H298	5KH48UN6054X	✓	170	H696	5KH36LNA504	✓	23
GT5304	145TFR16061	✓	141	H185	SEE H185A		38	H300	5KH49SN3048	✓	169	H697-(GE)	SEE X1903		102
GT5306	145TFR16011	✓	141	H185A	215TTDW14110		38	H344	5KH36KNB633X	✓	119	H698-(GE)	SEE X1904		102
GT5307	145TFR16069	✓	141	H185-(GE)	SEE B1504		172	H350	143TTGN7076	✓	79	H699-(GE)	SEE HG699		102
GT5401	143TFR16043	✓	140	H186	SEE H186A		38	H439	5KH39EN2552X	✓	120	H700	143TFR5376	✓	47
GT5403	143TFR16012	✓	141	H186A	254TTDX14104	✓	38	H440	5KH39EN2506X	✓	120	H700-(GE)	SEE HG700		170
GT5404	145TFR16075	✓	141	H186-(GE)	SEE HG186		172	H450-(GE)	SEE HG450		119	H701-(GE)	SEE HG701		169
GT5406	145TFR16015	✓	141	H187	256TTDX7101	✓	38	H45-(GE)	SEE HG451		119	H703-(GE)	SEE HG703		170
GT5407	145TFR16055	✓	141	H187A	256TTDN14102	✓	38	HG451	5KH32GNB813X	✓	119	H704-(GE)	SEE HG704		169
GT5501	143TFR16045	✓	140	H187-(GE)	SEE B1507		172	H454	5KH32ENB168X	✓	34	H705-(GE)	SEE HG705		170
GT5503	143TFR16014	✓	141	H188	SEE H188A		38	H455-(GE)	SEE HG455		34	H706-(GE)	SEE HG706		170
GT5504	145TFR16065	✓	141	H188A	284TTDN14102		38	H456-(GE)	SEE HG456		34	H710-(GE)	SEE HG710		26
GT5506	145TFR16019	✓	141	H188-(GE)	SEE HG188		172	H457	143TTFN8076	✓	49	H711-(GE)	SEE HG711		170
GT5507	145TFR16073	✓	141	H189	SEE H189A		38	H458-(GE)	SEE HG458		34	H712	5KH32GNB815X	✓	119
H112	5KH37PN39	✓	169	H189A	286TTDN14101		38	H502	449TTGS7068		81	H714-(GE)	SEE HG714		119
H113-(GE)	SEE HG113		169	H189-(GE)	SEE HG189		172	H503	449TTGS7037		81	H715-(GE)	SEE HG715		170
H114	5KH35FN124	✓	169	H190	5KH49MN3035	✓	172	H504	449TTGS7036	✓	81	H716-(GE)	SEE HG716		178
H115-(GE)	SEE HG115		169	H191	SEE H191A		38	H513	SEE E595		81	H717-(GE)	SEE HG717		178
H116	5KH32EN66	✓	29	H191A	326TTDR14105		38	H580	SEE E595		81	H8030	56T17D5398	✓	38
H120-(GE)	SEE HG120		29	H191-(GE)	SEE HG191		172	H581	SEE H502		81	H804	SEE X920		186
H121-(GE)	SEE HG121		29	H193	447TSTDN7003	✓	39,145	H601	SEE E901		36	H805	SEE X921		186
H123-(GE)	SEE HG123		29	H195	5KH32GN42	✓	102	H604	SEE E902		37	H806	SEE X922		186
H124-(GE)	SEE HG124		29	H196-(GE)	SEE HG196		102	H607	SEE E903		37	H812	447TSTDN7026	✓	39,145
H130	5KH39QN9632	✓	170	H197	5KH35MN132	✓	102	H613	SEE E1905		38	H813	447TSTDN7027	✓	39,145
H131	5KH39QN9631T	✓	170	H198	5KH35MN132S	✓	102	H615	SEE E937A		38	H814	447TSTDN7028	✓	39,145
H133	5KH39QN9642T	✓	170	H203	5KH36PN106	✓	102	H616	SEE E906		38	H815	SEE H815A		39,145
H134	5KH32FN3122	✓	102	H204	5KH32GN142	✓	174	H619	SEE E907		38	H815A	449TSTDN14033		39,145
H135	5KH32FN3122S	✓	102	H205	5KH37PN37	✓	174	H620	5KH49PN3043	✓	169	H816	449TSTDN7027		39,145
H136	5KH49MN6057	✓	102	H206	5KH36KN112	✓	174	H621	SEE E788		38	H817	447TSTDN7005	✓	39,145

Index

Catalog Number/Model Number

CAT. NO.	MODEL NO.	STOCK	PAGE NO.	CAT. NO.	MODEL NO.	STOCK	PAGE NO.	CAT. NO.	MODEL NO.	STOCK	PAGE NO.	CAT. NO.	MODEL NO.	STOCK	PAGE NO.
H818	449TSTDN7001	✓	39,145	HG695	5KH37PNA233	✓	169	I308	184TBDR7634	✓	193	K025	056T34D5304	✓	37
H819	SEE H819A		39,145	HG699	5KH49PN6056S	✓	102	I311	145TBFR5333	✓	194	K027	056T34D5300	✓	36
H819A	449TSTDN14005	✓	39,145	HG700	5KHC37NNA167T	✓	170	I314	SEE I314A		32,99,194	K032	056C17E5302	✓	34
H820	449TTDN7086	✓	39	HG701	5KH32DN5618X	✓	169	I314A	184TBFW7041	✓	32,99,194	K033	056C11G5303	✓	34
H821	SEE H821A		39	HG703	5KH35MNA519T	✓	170	I315	SEE I315A		32,99,194	K037	056C17G5308	✓	34
H821A	449TTDN14078	✓	39	HG704	5KH35MNA568T	✓	169	I315A	184TBFW7034	✓	32,99,194	K041	056T17D5310	✓	37
H822	SEE H822A		39	HG705	5KH46NN3039T	✓	170	I502	143TTGR16026	✓	76	K048	056T34D5340	✓	37
H822A	447TTDN14087	✓	39	HG706	5KH37PNA569T	✓	170	I503	143TTGR16030	✓	76	K049	056T17D2130	✓	37
H891	5KC49LN6386X	✓	34	HG710	5KH33JNA511T	✓	26	I504	145TTGR16076	✓	76	K061	056T17D5369	✓	37
H901	5KH32DNA612	✓	22	HG711	5KH32HNS620T	✓	170	I505	145TTGR16080	✓	76	K062	056T17D5370	✓	37
H902	5KH32DNA612X	✓	22	HG714	5KH37PNA479X	✓	119	I506	143TTGR16001	✓	76	K063	056T17D3301	✓	36
H903	5KH32FNA611	✓	22	HG715	5KH38SNA731T	✓	170	I507	143TTGR16005	✓	76	K064	056T17D3302	✓	37
H904	5KH32FNA611X	✓	22	HG716	5KH36DNA780X	✓	178	I508	145TTGR16038	✓	76	K065	056T17D3303	✓	37
H905	5KH36JNA769	✓	22	HG717	5KH37GNA782X	✓	178	I509	145TTGR16030	✓	76	K066	056T17D3304	✓	38
H906	5KH36JNA769X	✓	22	I101	143TCDR5303	✓	22	I512	145TTGR16002	✓	76	K067	056T17D3305	✓	36
H907	5KH37NNA768	✓	22	I102	145TBDR5302	✓	22	I513	145TTGR16004	✓	76	K068	056T17D3306	✓	37
H908	5KH37NNA768X	✓	22	I103	SEE I103A		22	I514	145TTGR16040	✓	76	K069	056T17D3307	✓	37
H912	5KH32DNA700	✓	169	I103A	182TCDW7001	✓	22	I515	145TTGR16039	✓	76	K080	056T17D3308	✓	38
H913	5KH32DNA700X	✓	169	I104	SEE I104A		22	I700	145TBFR5334	✓	30	K081	056T17D15528	✓	37
H914	SEE H160		169	I104A	184TBDW17008	✓	22	I702	145TBFR5336	✓	194	K111	SEE G044	✓	36
H915	5KH33FNA722X	✓	169	I105	213TCDW7001	✓	22,188	I707	143TBFR5376	✓	29	K113	5K35FN2	✓	36
H917	5KH35JNA723X	✓	170	I106	215TCDW17002	✓	22	J009	SEE C330	✓	121,176	K114	SEE G047	✓	36
H919	5KH36MNA735X	✓	170	I108A	184TBDW7001	✓	22,188	J013	SEE C332	✓	121,176	K115	5K36JN2	✓	36
H926	5KH36MNB637X	✓	119	I110	SEE C188		21	J017	SEE C334	✓	121,176	K116	5K42HN4106	✓	36
H950A		✓	119	I111	SEE C191		22	J019	SEE C336	✓	121,176	K117	SEE G067	✓	36
H951A		✓	119	I112A	182TCDW7026	✓	22	J021	SEE C338	✓	121,176	K118	SEE G080	✓	36
H952	145TTDR5647	✓	195	I113	SEE I113A		22	J023	SEE C340	✓	121,176	K119	5K46KN4071	✓	36
H953	182TTDR8353	✓	195	I113A	184TCDW7026	✓	22	J025	SEE J1025	✓	121,176	K120	SEE G088	✓	36
H954	184TTDR9040	✓	195	I114	SEE I114A		22,188	J033	SEE C329	✓	121	K121	SEE K000	✓	36
H955	213TTDW7053	✓	195	I114A	184TBDW7026	✓	22,188	J034	SEE C331	✓	121	K122	5K46MN4072	✓	36
H956	215TTDW7053	✓	195	I115	215TBDW7026	✓	22,188	J035	SEE C333	✓	121	K125	SEE K022	✓	37
H957	254TTDX8338	✓	195	I116	215TBDW7028	✓	22,188	J036	SEE C335	✓	121	K126	SEE K025	✓	37
H1613	SEE E1905		38	I117	213TCDW7026	✓	22	J037	SEE C337	✓	121	K136	SEE C1157	✓	24,171
H1668	184TFW7727	✓	48	I118	SEE C193		22	J038	SEE C339	✓	121	K151	5K32GN30	✓	47
HG113	5KH37PN39X	✓	169	I119	184TBDR7375	✓	188,193	J039	SEE C341	✓	121	K152	056B34D5320	✓	25
HG115	5KH35FN124X	✓	169	I127	145TBDR5337	✓	22,187,193	J040	SEE K748	✓	122	K153	5K33FN30	✓	47
HG120	5KH32FN3123	✓	29	I128	SEE I128A		193	J041	SEE K217	✓	122	K154	5K49FN4136	✓	47
HG121	5KH32FN3123X	✓	29	I128A	184TBDW7631	✓	193	J042	SEE KG219	✓	122	K155	5K36PN30	✓	47
HG123	5KH33FN85	✓	29	I130	SEE I130A		193	J043	SEE K221	✓	122	K158	5K35MNB117	✓	47
HG124	5KH33FN85X	✓	29	I130A	184TBDW7630	✓	193	J044	SEE K223	✓	122	K159	5K49MN6079	✓	47
HG138	5KH33JN3121	✓	102	I131	SEE I131A		193	J045	SEE K225	✓	122	K160	5K37NN30	✓	47
HG140	5KH36NN37	✓	102	I131A	184TBDW7632	✓	193	J046	SEE K227	✓	122	K161	5K36PNB111	✓	47
HG141	5KH36NN37S	✓	102	I141	182TCDR17079	✓	21	J047	056T34D5368	✓	122	K162	5K46PN6082	✓	47
HG142	5KH49PN6056	✓	102	I142	184TCDR076	✓	22	J048	056T34D5367	✓	122	K163	5K38RN30	✓	47
HG143	5KH42GN0337	✓	102	I143	213TCDW7076	✓	22	J049	056T34D5365	✓	122	K164	5K49MN4105	✓	47
HG152	5KH32GN140X	✓	169	I144	215TBDW7079	✓	22	J050	056T34D5366	✓	122	K165	5K49UN6085	✓	47
HG154	5KH36KN113X	✓	169	I145	145TBDR5303	✓	23	J051	056T34D5369	✓	122	K166	5K46KN2175	✓	48
HG155	5KH46MN3021X	✓	169	I146	145TCDR5331	✓	25,171	J052	056T34D5370	✓	122	K167	5K49SN4118	✓	48
HG156	5KH32DN3085	✓	169	I147	145TBDR5345	✓	25,171	J053	056T34D5371	✓	122	K194	5K33KN92	✓	47
HG161	5KH32FN3083X	✓	169	I201	145TBFR5327	✓	30	J054	056C34D2118	✓	121	K196	5K49FN4129	✓	47
HG178	5KH32EN79	✓	172	I204	145TBFR5301	✓	30	J055	056C34D2119	✓	121	K197	5K42HN4109	✓	47
HG182	5KH49MN6060	✓	172	I205	145TBFR5302	✓	30	J056	056C34D2120	✓	121	K198	5K49PN4113	✓	47
HG186	5KH46PN6059	✓	172	I206	182TBFR5301	✓	30	J057	056C34D2121	✓	121	K212	056B34D2018	✓	193
HG188	5KH49UN6064	✓	172	I210	SEE C295		30	J058	056B34D2033	✓	121	K215-(GE)	SEE KG215	✓	40,122,176
HG189	5KH36PN108	✓	172	I211	SEE C297		30	J059	056B34D5341	✓	121	K216	5K36JN57	✓	40,122,176
HG191	5KH46PN3033	✓	172	I212	182TBFR5326	✓	30	J060	056T34F5308	✓	123	K217	5K36JN56	✓	122
HG196	5KH32GN42S	✓	102	I213	SEE I213A		30	J061	056T34F5342	✓	123	K218	5K37MN37	✓	40,122,176
HG450	5KH32GNB812X	✓	119	I213A	184TBFW17044	✓	30	J062	056T34F5343	✓	123	K219	056B34D5336	✓	193
HG455	5KH36NNB166X	✓	34	I214	SEE I214A		30	J063	056T34F5344	✓	123	K219-(GE)	SEE KG219	✓	122
HG456	5KH35LNB164X	✓	34	I214A	184TBFW7726	✓	30	J064	056T34F5345	✓	123	K220	5K38PN47	✓	40,122,176
HG458	5KH36PNB171X	✓	34	I215	215TBFW7026	✓	30	J065	056T34F5346	✓	123	K221	5K38PN48	✓	122
HG621	5KH49PN6055X	✓	170	I216	213TBFW7026	✓	30	J066	056T34F5347	✓	123	K222	5K46KN2173	✓	40,122,176
HG646	5KH39QN9508Y	✓	100	I217	215TBFW7027	✓	30	K1025	5KC37FN71X	✓	121,176	K223	5K46KN2172	✓	122
HG648	5KHC39QN9581T	✓	102	I220	143TBFR5301	✓	30	K000	056T34D5302	✓	36	K224	5K49NN2180	✓	40,122,176
HG679	5KH32DN5597X	✓	119	I221	145TBFR5303	✓	30	K003	056T17D2113	✓	36	K225	5K49NN2178	✓	122
HG680	5KH32FN5598X	✓	119	I223	SEE I223A		30	K004	056T17D2092	✓	36	K226	5K48TN2182	✓	40,122,176
HG681	5KH32GNB814X	✓	119	I223A	184TBFW7701	✓	30	K007	056T11D5304	✓	37	K227	5K48TN2181	✓	122
HG690	5KH35JN602X	✓	25	I224	213TBFW7001	✓	30	K009	056T34D5303	✓	37	K228	SEE P101	✓	51,123
HG692	5KH36LN489X	✓	26	I225	215TBFW7001	✓	30	K016	056B17D56	✓	187,193	K229	SEE P102	✓	51,123
HG694	5KH39QN9767X	✓	170	I305	184TBDR7628	✓	193	K022	056T17D5309	✓	37	K230	5K35JN47	✓	123

Catalog Number/Model Number

CAT. NO.	MODEL NO.	STOCK	PAGE NO.	CAT. NO.	MODEL NO.	STOCK	PAGE NO.	CAT. NO.	MODEL NO.	STOCK	PAGE NO.	CAT. NO.	MODEL NO.	STOCK	PAGE NO.
K231	SEE P103		51,123	K461	5K49UN4566	✓	97	K1300	5K49PN6019	✓	40	K2022A		✓	41
K232	056B17D5322	✓	193	K462	5K49UN4567	✓	97	K1305	5K42FN4033	✓	41	K2023	5KE49UN8407	✓	41
K232-(GE)	SEE KG232		123	K469	5K42HN4137	✓	51	K1306	5K49FN2045	✓	41	K2024	SEE C150A		40
K233	SEE P104		51,123	K499	SEE D392		53	K1307	5K42HN4032	✓	41	K2025	SEE C201A		51
K234	056C17D2114		28	K500	5K38RN106	✓	53	K1308	5K46KN4031	✓	41	K2026	SEE GT1203		63
K234-(GE)	SEE KG234		123	K501	SEE D395		54	K1311	5K49NN2046	✓	41	K2027	SEE C202A		51
K235	056C17D2115	✓	28	K518	5K49SN3054	✓	173	K1314	SEE G586		53	K2028	SEE GT1206		63
K235-(GE)	SEE KG235		51	K519	5K49SN3055	✓	173	K1315	SEE G587		53	K2029	SEE C220A		51
K236	SEE E261		28	K520	5K48UN3056	✓	173	K1316	5K49MN6020	✓	51	K2030	5KE49TN8384T		173
K236-(GE)	SEE KG236		123	K521	5K49PN4120	✓	40	K1317	5K49PN6025	✓	51	K2031	SEE GT1204		63
K237	SEE E270		28	K522	5K33KN67	✓	51	K1318	5K49PN8030	✓	51	K2032	SEE GT1201		63
K237-(GE)	SEE KG237		51	K523	5K36PN254	✓	51	K1322	5K42FN4035	✓	53	K2033	5KE48WN8365	✓	51
K238	5K49SN2184	✓	123	K524	5K49MN4112	✓	51	K1323	SEE D391		53	K2034	SEE GT1207		63
K239	SEE P107		52,123	K525	5K49MN4114	✓	172	K1324	5K42HN4034	✓	53	K2035	SEE C250		51
K240	5K49ZN2190	✓	123	K526	5K49MN6369	✓	97	K1325	SEE G588		53	K2036	SEE GT1202		63
K247	5K49DN4132	✓	40	K527	5K35JN198	✓	36	K1326	SEE G589		53	K2037	5KE49UN8376T		173
K248	5K49FN4138	✓	40	K541	5K49MN6081	✓	172	K1328	SEE D394		54	K2038	5KE49QN8375T		173
K249	5K42HN4127	✓	40	K544	5K42JN3051	✓	173	K1402	5K39SNB5055S	✓	165	K2039	SEE GT1201		63
K250	5K46KN4125	✓	40	K546	5K42JN3050	✓	173	K1403	5K36PN3455S	✓	165	K2042	SEE C236A		52
K251	5K46MN4126	✓	40	K549	5K48UN3057	✓	173	K1404	5K38SN2675S	✓	165	K2043	5KE49UN8428	✓	40
K252	5K49DN4130	✓	51	K550	5K42HN4133	✓	123	K1405	5K39SNB765T	✓	165	K2045	5KE49WN4571	✓	97
K253	5K33JN4943	✓	51	K553	5K42HN4139	✓	122	K1407	5K39SNB5875S	✓	165	K2046	5KE49WN4572	✓	97
K254	5K35MN8114	✓	51	K555	5K46KN4141	✓	122	K1408	5K42HN4089X	✓	173	K2048	SEE C221A		51
K255	5K36PN8116	✓	51	K606	5K42GN4619X	✓	65	K1409	5K37MN252X	✓	173	K2049	SEE E2106		57
K256	5K49MN4104	✓	51	K607	5K49MN4620X	✓	65	K1410	5K46KN4085X	✓	173	K2051	SEE N323		106
K257	5K49SN4117	✓	51	K608	5K49MN4618X	✓	65	K1411	5K38PN258X	✓	173	K2052	SEE N321A		106
K258	5K49KN4124	✓	53	K609	5K49TN4622X	✓	65	K1412	5K46MN4087X		173	K2053	SEE N312A		106
K259	5K49MN4110	✓	53	K610	5K49RN4621X	✓	65	K1413	5K49KN2150X	✓	173	K2055	5KE49TN8378	✓	107
K260	5K49SN4119	✓	54	K612	056B34F5306	✓	194	K1415	5K49PN4088X	✓	173	K2056	5KE48WN8364	✓	107
K275	5K33GN45	✓	173	K615	056B34F5312	✓	194	K1416	5K49NN2147X	✓	173	K2058	SEE N607		108
K277	5K46KN4085	✓	173	K618	056B34F5318	✓	194	K1418	5K49UN4086X	✓	173	K2059	SEE N629		108
K278	5K46MN4087	✓	173	K622	5K49RN8424	✓	40	K1438	5K49NN4052T	✓	104	K2060	SEE N610		108
K279	5K49PN3053	✓	173	K622A	145TTDR14049	✓	40	K1476	5K49JN4051T	✓	104	K2061	SEE N612A		108
K280	5K49PN3052	✓	173	K631	056B34F5324		32	K1482	5K48WN3013S	✓	165,177	K2062	SEE N630		108
K281	5K32GN48	✓	172	K633	5K36MN4152	✓	51	K1483	5K37MN3543	✓	122	K2063	SEE N613A		108
K282	5K35MN294	✓	172	K634	SEE K634A		40	K1484	5K46KN2082	✓	122	K2064	SEE G347		47
K283	5K33KN52	✓	172	K634A	143TTDR14049	✓	40	K1485	5K49RN6118S		164	K2065	SEE N611		108
K284	5K42HN4128	✓	172	K635	5K46MN4623	✓	41	K1486	5K48TN6119S	✓	164,177	K2066	5KE48WN4593	✓	107
K285	5K49MN6080	✓	172	K637	SEE P106		51,123	K1487	5K49MN6126T	✓	178	K2067	5KE49TN4597	✓	108
K286	5K49KN4142	✓	172	K640	5K49QN4609	✓	52	K1490	5K49PN6164	✓	51	K2068	5KE49TN4592	✓	107
K318	5K42JN4163	✓	36	K642	SEE P105		51,123	K1491	5K49ZN4253	✓	51	K2069	5KE49PN4594	✓	36
K319	056B17F5319	✓	32,99,194	K644	5K49ZN4611	✓	40	K1492	5K49ZN4252	✓	48	K2084	SEE K2033		51
K319-(GE)	SEE KG319		195	K646	5K49RN4617	✓	41	K1494	5K49RN4570	✓	97	K2085	SEE Y366		84
K321	5K35MN75	✓	47	K648	5K49ZN4616	✓	41	K1497	5K49WN4335X	✓	173	K2087	SEE Y368		84
K330	SEE K2033		51	K690	5K46HN2546	✓	41	K1500	5K49MN6432S	✓	165	K2088	SEE GT1209		64
K332	056B34F5303		194	K700	056T11F5328	✓	54	K1505	5K46LN6428S	✓	165	K2090	SEE K1491		51
K339	056C34F5327		29	K701	056T11F5307	✓	53	K1510	5K49RN6429S		165	K2101	5K49FN6381X	✓	76
K350	056B34F5322		30	K702	056T34F5309		53	K1511	5K48WN3181S	✓	165,177	K2102	5K49JN4582X		76
K378	5K46LN6033S		165	K703	056T11F5316	✓	53	K1515	5K48TN6430S		165	K2103	SEE G649		76
K379	5K49RN6034S		165	K704	056T34F5348	✓	53	K1520	5K49ZN6433S	✓	165	K2104	5K49HN6385X	✓	76
K381	5K42HN4089	✓	173	K705	056T11F5336	✓	53	K2001	SEE E783		37	K2105	5K49JN4574X	✓	76
K392	SEE G086		36	K706	056T34F5349	✓	53	K2002	SEE U246		42	K2106	SEE G661		76
K393	SEE K007		37	K707	056T11F5337	✓	53	K2003	SEE E784		37	K2107	5K49MN8349X	✓	76
K402	SEE H181		36	K708	056T34F5350	✓	53	K2004	SEE U1248		43	K2108	SEE G662		76
K404	056T11F5320		51	K709	056T11F5338	✓	53	K2005	SEE U758		42	K2109	SEE G663		76
K405	056T11F72047		51	K717	5K32GNB249X	✓	76	K2006	SEE U759		42	K2110	5K49TN6383X	✓	76
K406	SEE K640		52	K718	SEE G647		76	K2007	SEE U760		42	K2111	5K49NN4580X	✓	76
K407	056T11F5321		51	K721	056T34F5351	✓	54	K2010	SEE E914A		37	K2112	SEE G829		77
K408	5K49SN8050	✓	37	K722	056T11F5339	✓	54	K2011	SEE E2109		57	K2113	SEE G840		77
K418	5K32GN53	✓	47	K723	056T34F5352	✓	54	K2012	SEE E2101		56	K2114	SEE G841		77
K420	SEE K151		47	K724	056T11F5340	✓	54	K2013	SEE E2126		56	K2115	5K49NN4581X	✓	77
K421-(GE)	SEE G1340		47	K725	056T34F5353	✓	54	K2014	SEE E2104		56	K2116	5K49MN6382X	✓	76
K424	5K49MN4111	✓	47	K748	5K35FN101	✓	122	K2015	SEE E838		48	K2201	SEE I502		76
K426	5K42HN4134	✓	47	K750	5K46MN4144	✓	122	K2016	SEE E2107		57	K2202	SEE I504		76
K439	5K49DN4131	✓	47	K751	5K49PN4121	✓	122	K2017	SEE E847		48	K2203	SEE I506		76
K456	5K49KN4573	✓	97	K803	SEE K500		53	K2018	5KE49PN8418	✓	40	K2205	SEE I512		76
K457	5K49KN4563	✓	97	K806	056T11F5330	✓	54	K2019	SEE C102A		40	K2206	SEE I514		76
K458	5K49PN4564	✓	97	K1221	SEE K700		54	K2020	SEE C103		40	KG215	5K35FN55	✓	40,122,176
K459	5K49UN4569	✓	97	K1222	SEE K701		53	K2021	5KE49PN8391		41	KG219	5K37MN38	✓	122
K460	5K49PN4565	✓	97	K1299	5K46MN6018	✓	40	K2022	5KE49TN8401	✓	41	KG232	5K36MN339	✓	123

Index

Catalog Number/Model Number

CAT. NO.	MODEL NO.	STOCK	PAGE NO.	CAT. NO.	MODEL NO.	STOCK	PAGE NO.	CAT. NO.	MODEL NO.	STOCK	PAGE NO.	CAT. NO.	MODEL NO.	STOCK	PAGE NO.
KG234	5K38RN49	✓	123	M115A	184TTDW7358	✓	136	M362	SEE E107A		126	M823	SEE M823A		153
KG235	5K49PN2348	✓	51	M116	SEE U177A		136	M363	SEE E153A		126	M823A	324TTDR14080		153
KG236	5K49PN2330	✓	123	M117	SEE U183		136	M401	SEE U301		130	M824	SEE M824A		153
KG237	5K49SN2187	✓	51	M118	SEE U189A		136	M402	SEE U307		130	M824A	326TTDR14103		153
KG319	5K49UN8052	✓	195	M119	SEE U195		136	M403	SEE U310A		130	M825	SEE M825A		153
L102	SEE E1904		38	M120	SEE U201A		136	M404	SEE U313A		130	M825A	284TTDR14011		153
L409	SEE L409A		49	M121	SEE U207		136	M405	SEE U316A		131	M826	SEE M826A		153
L409A	182TTFN4101	✓	49	M122	SEE U210		136	M406	SEE U319A		131	M826A	286TTDR14042		153
L410	SEE L410A		49	M123	SEE U213		137	M407	SEE U322A		131	M828	SEE M828A		153
L410 A	184TTFN14101	✓	49	M124	SEE U219		137	M408	SEE U325A		131	M828A	364TTDS14104		153
L410B	184TTFN4102	✓	49	M125	SEE U225		137	M409	SEE U329		131	M829	286TTDR17009		153
L411	SEE L411A		49	M126	SEE U228A		137	M410	SEE U334		131	M830	SEE M830A		153
L411A	213TTFN4103	✓	49	M127	SEE U231		137	M411	SEE U337		131	M830A	324TTDR14049		153
L412	SEE L412A		49	M128	SEE U234		137	M412	SEE U340		131	M831	SEE M831A		153
L412A	254TTFNA14103	✓	49	M129	SEE U236		137	M413	SEE U344		131	M831A	364TTDS14081		153
L413	SEE L413A		49	M130	SEE U238		137	M414	SEE U351		131	M832	SEE M832A		153
L413A	256TTFNA14101	✓	49	M131	SEE U242		137	M415	SEE U304A		130	M832A	365TTDS14101		153
L414	SEE L414A		49	M133	SEE U240		137	M416	SEE U360		131	M833	SEE M833A		153
L414A	284TTFNA14102	✓	49	M163	SEE U299		136	M416A	SEE U360		131	M833A	324TTDR14010		153
L415	SEE L415A		49	M165	SEE U186A		136	M417	SEE U357		131	M834	SEE M834A		153
L415A	286TTFNA14106	✓	49	M166	SEE U192		136	M418	SEE U363		131	M834A	326TTDR14034		153
L416	SEE L416A		50	M167	SEE U198A		136	M420	SEE U348		131	M835	SEE M835A		153
L416A	324TTFN14101	✓	50	M168	SEE U204		136	M421	SEE U348		131	M835A	365TTDS14082		153
L417	SEE L417A		50	M170	SEE U159A		135	M422	SEE U319A		131	M836	SEE M836A		153
L417A	326TTFN14101	✓	50	M171	SEE U162A		135	M423	SEE U322A		131	M836A	404TTDS14102		153
L420	364TTFN8101	✓	50	M172	SEE U165A		136	M717			154	M837	SEE M837A		154
L421	SEE L421A		49	M213	SEE U345A		137	M718	256TTDN16053		154	M837A	326TTDR14010		154
L421 A	215TTFN14103	✓	49	M216	SEE U372		137	M719			154	M838	SEE M838A		154
L425	365TTFN8115	✓	50	M217	SEE U366		137	M721			154	M838A	364TTDR14032		154
L426	404TTFN8102	✓	50	M301	SEE E100		125	M722	256TTDN16011		154	M839	SEE M839A		154
L427	405TTFN8114	✓	50	M302	SEE E118		125	M723			154	M839A	404TTDS14081		154
L428	444TTFN8106		50	M303	SEE E123		125	M741			154	M840	405TTDS7124		154
L429	445TTFN8115	✓	50	M304	SEE E095		125	M742	365TTDS16072		154	M841	SEE M841A		154
L440	445TTFN8102		50	M305	SEE E102		125	M743			154	M841A	364TTDS14011		154
L442	449TTFN8111		50	M306	SEE E128		125	M749			154	M842	SEE M842A		154
L449	449TTFN8110	✓	50	M307	SEE E096		125	M750	405TTDS16070		154	M842A	365TTDS4328		154
L450	SEE L451A		50	M308	SEE E133		125	M801	SEE M801A		153	M843	SEE M843A		154
L451	SEE L451A		50	M309	SEE E104		125	M801A	182TTDR14027		153	M843A	405TTDS4376		154
L451A	449TTFN14007	✓	50	M310	SEE E138		125	M802	SEE M802A		153	M844	SEE M844A		154
L452	445TTFN8040	✓	50	M311	145TTDRS315	✓	125	M802A	213TTDW14084		153	M844A	444TTDS14101		154
L453	445TTFN8041		50	M312	145TTDRS316	✓	125	M803	SEE M803A		153	M845	SEE M845A		154
L454	449TTFN8038	✓	50	M313	SEE E097		125	M803A	182TTDR14026		153	M845A	365TTDS14009		154
L455	449TTFN8028		50	M314	SEE E098		126	M804	SEE M804A		153	M846	SEE M846B		154
L456	449TTFN8087	✓	50	M315	SEE M1315		126	M804A	184TTDR4173		153	M846A	SEE M846B		154
L457	449TTFN8077		50	M316	SEE M1316		126	M805	SEE M805A		153	M846B	404TTDS14074		154
L459	449TTFN8002	✓	50	M317	SEE M1317		126	M805A	215TTDW14087		153	M847	SEE M847A		154
L460	SEE L462		50	M318	SEE E158A		126	M807	SEE M807A		153	M847A	444TTDS14086		154
L461	SEE L472A		50	M319	SEE E109A		126	M807A	213TTDW14054		153	M848	445TTDS7121		154
L462	449TTFN8037	✓	50	M320	SEE E163A		126	M808	SEE M808A		153	M849	SEE M849A		154
L463	449TTFN8027	✓	50	M321	SEE E110		127	M808A	254TTDX14088		153	M849A	404TTDS14005		154
L464	449TTFN8086	✓	50	M322	SEE E168		127	M810	SEE M810A		153	M850	SEE M850A		154
L465	449TTFN8076		50	M323	SEE E111		127	M810A	215TTDW4071		153	M850A	405TTDS14067		154
L466	449TTFN8001	✓	50	M324	SEE E173		127	M811	SEE M811A		153	M851	SEE M851A		154
L467	449TTFN8036	✓	50	M325	SEE E112		127	M811A	256TTDX4094		153	M851A	445TTDS14087		154
L469	SEE L469A		50	M326	SEE E178		127	M813	SEE M813A		153	M852	505UTDS805		154
L469A	449TTFN14043	✓	50	M327	SEE E113		127	M813A	215TTDW14018		153	M853	SEE M853A		154
L471	449TTFN18105		50	M328	SEE E183		127	M814	SEE M814A		153	M853A	405TTDS14003		154
L472	SEE L472A		50	M329	SEE E114A		127	M814A	254TTDX14064		153	M854	SEE M854A		154
L472A	---		50	M330	SEE E191		127	M815	SEE M815A		153	M854A	444TTDS14057		154
L633	SEE U605A		48	M331	SEE E197		127	M815A	284TTDR14082		153	M855	SEE M855A		154
M101	SEE U123A		135	M332	SEE U103		127	M818	SEE M818A		153	M855A			154
M102	SEE U126		135	M333	SEE U160		127	M818A	256TTDX14039		153	M856	505UTDS819		154
M103	SEE U129A		135	M334	SEE U109A		127	M819	SEE M819A		153	M857	SEE M857A		154
M105	SEE U135A		135	M335	SEE U114		127	M819A	286TTDR14081		153	M857A	444TTDS14003		154
M109	SEE U147A		135	M351	SEE U112		127	M820	SEE M820A		153	M858	SEE M858A		154
M110	SEE U150A		135	M352	SEE U116		127	M820A	324TTDR14104		153	M858A	445TTDS14063		154
M111	SEE U153		135	M353	SEE E118		127	M821	SEE M821A		153	M859	SEE M859A		154
M113	SEE U159A		135	M358	SEE U118		127	M821A	256TTDX4310		153	M859A	505UTDS14077		154
M114	SEE U165A		136	M360	SEE E106A		126	M822	SEE M822A		153	M860	505UTDS5820		154
M115	SEE M115A		136	M361	SEE E148A		126	M822A	286TTDR14046		153	M861	SEE M861A		154

Catalog Number/Model Number

CAT. NO.	MODEL NO.	STOCK	PAGE NO.	CAT. NO.	MODEL NO.	STOCK	PAGE NO.	CAT. NO.	MODEL NO.	STOCK	PAGE NO.	CAT. NO.	MODEL NO.	STOCK	PAGE NO.
M861A	445TTDS14003		154	M910A	365TTFS14084		157	M1444			156	N210	184TTWW14004	✓	109
M862	SEE M862A		154	M912	SEE M912A		158	M1445			156	N211	213TTWW14031	✓	109
M862A	445TTDS14062		154	M912A	364TTFS14003		158	M1446			156	N212	215TTWW14009	✓	109
M863	SEE M863A		154	M913	SEE M913A		158	M1447			156	N213	215TTWW14031	✓	109
M863A	505UTDS3999		154	M913A	364TTFS14058		158	M1448			156	N214	215TTWW14007	✓	109
M864	---		154	M914	SEE M914A		158	M1449			156	N220	056T34W99003	✓	109
M866	SEE M866A		154	M914A	404TTFS14088		158	M1450			156	N222	056T34W99004	✓	109
M866A	---		154	M916	SEE M916A		158	M1451			156	N224	056T34W99005	✓	109
M867	SEE M867A		154	M916A	365TTFS7923		158	M1452			156	N226	056T34W99006	✓	109
M867A	---		154	M917	SEE M917A		158	M1453			156	N228	056T34W99009	✓	109
M868	---		154	M917A	365TTFS14060		158	M1454			156	N230	056T34W99007	✓	109
M869	SEE M869A		154	M918	SEE M918A		158	M1455			156	N232	056T34W99010	✓	109
M869A	---		154	M918A	405TTFS14087		158	M1456			156	N234	056T34W99011	✓	109
M870	---		154	M919	444TTFS7403		158	M1457			156	N236	056T34W99008	✓	109
M871	SEE M871A		154	M920	405TTFS7612		158	M1458			156	N238	056T34W99012	✓	109
M871A	---		154	M921	SEE M921A		158	M1459			156	N270	056C17V5304	✓	113
M873	---		154	M921A	405TTFS14063		158	M1460			156	N271	056C17V5302	✓	113
M874	---		154	M922	SEE M922A		158	M1461			156	N272	056B17V5301	✓	113
M875	SEE M875A		157	M922A	444TTFN14080		158	M1462			156	N273	056B17V5302	✓	113
M875A	182TFW14005		157	M924	444TTFS7321		158	M1463			156	N274	145TBWDS327	✓	113
M876	SEE M876A		157	M925	SEE M925A		158	M1464			156	N275	145TBWDS326	✓	113
M876A	182TFW14026		157	M925A	444TTFN14044		158	M1465			156	N280	056C17V5303	✓	113
M877	SEE M877A		157	M926	SEE M926A		158	M1466			156	N281	056C34V5302	✓	113
M877A	213TFW14080		157	M926A	445TTFN14086		158	M1467			156	N282	056C17V5301	✓	113
M879	SEE M879A		157	M928	SEE M928A		158	M1468			156	N283	056B17V5303	✓	113
M879A	184TFW14026		157	M928A	445TTFN14003		158	M1469			156	N284	056C34V5301	✓	113
M880	SEE M880A		157	M929	SEE M929A		158	M1470			156	N285	056B17V5304	✓	113
M880A	215TFW14083		157	M929A	445TTFN14326		158	M1471			156	N286	056B34W5301	✓	113
M881	SEE M881A		157	M931	449TTFS7109		158	M1472			156	N287	145TBWDS329	✓	113
M881A	213TFW14010		157	M933	SEE M933A		158	M1473			156	N288	145TBWDS301	✓	113
M883	SEE M883A		157	M933A	445TTFN14330		158	M1474			156	N289	145TBWDS328	✓	113
M883A	254TTFNA14084		157	M1114	SEE U165A		136	M1475			156	N291	056T17W5329	✓	115
M884	SEE M884A		157	M1116	SEE U177A		136	M1476			156	N292	143TTWD16031	✓	115
M884A	215TFW14021		157	M1216	SEE U372		137	M1477			156	N293	056T17W5336	✓	115
M885	SEE M885A		157	M1314	SEE E098		126	M1478			156	N294	056T17W5337	✓	115
M885A	215TFW14040		157	M1315	182TTDB7325	✓	126	M1479			156	N309	056T17V5346	✓	106
M886	SEE M886A		157	M1316	182TTDB7601	✓	126	M1480			156	N310	143TTWR5329	✓	106
M886A	256TTFNA14084		157	M1317	184TTDW7357	✓	126	M1481			156	N312	SEE N312A		106
M888	254TTFNA7012		157	M1318	SEE E158A		126	M1482			156	N312A	145TTWR6027	✓	106
M889	254TTFNA14072		157	M1319	SEE E109A		126	M1483			156	N313	056T17W5328	✓	106
M890	SEE M890A		157	M1320	SEE E163A		126	N151	143TTWD14031	✓	116	N314B	182TTWW6027	✓	106
M890A	284TFPA14049		157	M1322	SEE E168		127	N152	143TTWD14002	✓	116	N315	SEE N315A		106
M892	SEE M892A		157	M1323	SEE E111		127	N153	145TTWD14031	✓	116	N315A	184TTWW6004	✓	106
M892A	256TTFNA14016		157	M1327	SEE E113		127	N154	145TTWD14002	✓	116	N316	SEE N316B		106
M893	256TTFNA7028		157	M1407	SEE U322A		131	N155	145TTWD14032	✓	116	N316B	184TTWW6027	✓	106
M894	SEE M894A		157	M1408	SEE U325A		131	N156	145TTWD14003	✓	116	N317	SEE N317A		106
M894A	286TTFNA14085		157	M1420			155	N157	182TTWD14033	✓	116	N317A	184TTWW6003	✓	106
M896	284TTFNA7508		157	M1421			155	N158	184TTWD14003	✓	116	N318	SEE N318A		106
M897	SEE M897A		157	M1422			155	N159	184TTWD14033	✓	116	N318A	213TTWR6027	✓	106
M897A	284TFPA14048		157	M1423			155	N160	213TTWD14002	✓	116	N319	SEE N319A		106
M898	SEE M898A		157	M1424			155	N161	213TTWD14032	✓	116	N319A	215TTWR6027	✓	106
M898A	324TFPA14089		157	M1425			155	N162	215TTWD14002	✓	116	N320	056T17W5340	✓	106
M899	SEE M899A		157	M1426			155	N163	215TTWD14032	✓	116	N321	SEE N321A		106
M899A	326TTFS14103		157	M1427			155	N180	SEE N180A		115	N321A	145TTWR6029	✓	106
M900	SEE M900A		157	M1428			155	N180A	056T11V5379	✓	115	N322	056T17W5344	✓	106
M900A	286TFPA14011		157	M1429			155	N181	SEE N181A		115	N323	145TTWR6076	✓	106
M901	SEE M901A		157	M1430			155	N181A	056T11V5380	✓	115	N324	145TTWR16002	✓	106
M901A	286TFPA14063		157	M1431			155	N182	SEE N182A		115	N325	213TTWW16002	✓	106
M902	SEE M902A		157	M1432			155	N182A	056T11W5379	✓	115	N340	056C34WDS301	✓	110
M902A	326TTFS14087		157	M1433			155	N183	SEE N183A		115	N341	056C17WDS327	✓	110
M904	SEE M904A		157	M1434			155	N183A	056T11W5380	✓	115	N342	056C34WDS302	✓	110
M904A	324TTFS14003		157	M1435			155	N201	143TTWR14032	✓	109	N343	056C17WDS328	✓	110
M905	SEE M905A		157	M1436			155	N202	143TTWR14002	✓	109	N344	056C34WDS303	✓	110
M905A	324TFPA14065		157	M1437			155	N203	143TTWR14031	✓	109	N345	056C17WDS329	✓	110
M906	SEE M906A		157	M1438			155	N204	145TTWR14003	✓	109	N346	056C34WDS304	✓	110
M906A	364TTFS14087		157	M1439			155	N205	145TTWR14031	✓	109	N347	056C17WDS330	✓	110
M907	365TTFS17102		157	M1440			156	N206	145TTWR14004	✓	109	N348	145TBWDS305	✓	110
M909	SEE M909A		157	M1441			156	N207	182TTWW14031	✓	109	N349	145TBWDS335	✓	110
M909A	326TFPA14049		157	M1442			156	N208	184TTWW14005	✓	109	N351	056T17V99006	✓	109
M910	SEE M910A		157	M1443			156	N209	184TTWW14031	✓	109	N353	056T17V99007	✓	109

Index

Catalog Number/Model Number

CAT. NO.	MODEL NO.	STOCK	PAGE NO.	CAT. NO.	MODEL NO.	STOCK	PAGE NO.	CAT. NO.	MODEL NO.	STOCK	PAGE NO.	CAT. NO.	MODEL NO.	STOCK	PAGE NO.
N355	056T17V99008	✓	109	N445	SEE N445A		115	N566	056T34V5305	✓	108	N657B	184TTWW4002	✓	107
N357	056T17V99005	✓	109	N445A	184TTWD16002	✓	115	N567	056T17V5336	✓	108	N658	SEE N658B		107
N358	143TTVR5331	✓	109	N446	SEE N446A		115	N568	056T11V5376	✓	108	N658B	184TTWW4028	✓	107
N360	145TTWR14032	✓	109	N446A	213TTWD16002	✓	115	N569	056T34V5306	✓	108	N659	SEE N659A		107
N362	145TTWR14033	✓	109	N447	SEE N447A		115	N599	056T17V5338	✓	108	N659A	213TTWR4001	✓	107
N371	056T17V99003	✓	109	N447A	215TTWD16002	✓	115	N600	056T11V5377	✓	108	N660	213TTWR7026	✓	107
N373	056T17V99004	✓	109	N448	SEE N448A		114	N601	056T34V5307	✓	108	N661	215TTWR7026	✓	107
N375	056T17V99002	✓	109	N448A	182TTWD14032	✓	114	N602	056T17V5340	✓	108	N662	056T34W99001	✓	107
N377	056T17V99009	✓	109	N449	SEE N449A		114	N604	056T11W5377	✓	108	N663	215TTWW16002	✓	107
N378	143TTVR5330	✓	109	N449A	184TTWD14032	✓	114	N605	056T34V5308	✓	108	N664	215TTWW14008	✓	107
N380	145TTWR17031	✓	109	N450	056T34VD5301	✓	112	N606	056T17V5342	✓	108	N665	056T34V99001	✓	107
N382	145TTWR17032	✓	109	N451	056T34VD5302	✓	112	N607	145TTVR5326	✓	108	N666	056T17W99003	✓	107
N388A	056T17V5354	✓	116	N452	056T34VD5303	✓	112	N608	056T11W5378	✓	108	N667	056T34V99002	✓	107
N389A	056T17V5355	✓	116	N453	056T34WD5301	✓	112	N609	056T34V5309	✓	108	N668	056T17W99006	✓	107
N400	056T17V5347	✓	115	N454	SEE N454A		112	N610	145TTVR5302	✓	108	N669	056T17W99002	✓	107
N401	056T17V5348	✓	115	N454A	143TTWD6001	✓	112	N611	056T17W5327	✓	108	N680	056C17W5336	✓	105
N402	056T17V5349	✓	115	N455	056T34WD5302	✓	112	N612	SEE N612A		108	N681	056C17W5337	✓	105
N403	143TTVD5326	✓	115	N456	143TTWD4002	✓	112	N612A	145TTWR6026	✓	108	N682	056C17W5338	✓	105
N404	SEE N404A		115	N456A	143TTWD6002	✓	112	N613S	EE N613A		108	N683	145TCWR5326	✓	105
N404A	145TTWD6026	✓	115	N457	056T34WD5303	✓	112	N613A	145TTWR6001	✓	108	N684	SEE N684A		105
N405	SEE N405A		115	N458	SEE N458A		112	N614	SEE N614B		108	N684A	182TCWW7026	✓	105
N405A	145TTWD6027	✓	115	N458A	145TTWD6001	✓	112	N614B	182TTWW6026	✓	108	N685	143TCWR17031	✓	105
N406	SEE N406A		115	N459	145TTWD6030	✓	112	N615	SEE N615B		108	N701	048T17V11001	✓	118
N406A	182TTWD6031	✓	115	N460	048T17V2001	✓	114	N615B	184TTWW6001	✓	108	N703	056T34V99013	✓	118
N407	SEE N407A		115	N461	048T17V2002	✓	114	N616	SEE N616B		108	N704	048T17V11002	✓	118
N407A	184TTWD6031	✓	115	N462A	056T17V5353	✓	114	N616B	184TTWW6026	✓	108	N705	056T17V99016	✓	118
N408	SEE N408A		115	N463A	056T17V5352	✓	114	N617	SEE N617A		108	N707	056T34V99014	✓	118
N408A	213TTWD6031	✓	115	N464A	056T17V5356	✓	114	N617A	213TTWR6002	✓	108	N708	056T17V99011	✓	118
N409	SEE N409A		115	N465A	056T17W5331	✓	114	N618	SEE N618A		108	N710	056T34V99011	✓	118
N409A	215TTWD6031	✓	115	N466	143TTVD5327	✓	114	N618A	213TTWR6026	✓	108	N711	056T17V99012	✓	118
N410	056T17VD5326	✓	112	N467	143TTWD14032	✓	114	N619	SEE N619A		108	N713	143TTWD16004	✓	118
N411	056T17VD5328	✓	112	N468A	056T17W5330	✓	114	N619A	215TTWR6026	✓	108	N715	056T17W99007	✓	118
N412	056T17VD5327	✓	112	N469	145TTWD14034	✓	114	N620	SEE N620A		108	N716	143TTWD16033	✓	118
N413	056T17VD5326	✓	112	N470A	056T17W5332	✓	114	N620A	056T17V15501	✓	108	N718	145TTWD16004	✓	118
N414	SEE N414A		112	N471	145TTWD14033	✓	114	N621	056T17W5335	✓	108	N720	056T17W99009	✓	118
N414A	143TTWD6026	✓	112	N480A	056T34V5316	✓	114	N622	056T17V5337	✓	108	N721	145TTWD16032	✓	118
N415	056T17WD5329	✓	112	N481A	056T34V5317	✓	114	N623	056T17W5339		108	N753	056T34V99012	✓	118
N416	SEE N416A		112	N482A	056T34V5313	✓	114	N626	SEE N626A		108	N755	056T17V99015	✓	118
N416A	145TTWD6028	✓	112	N483	143TTWD14003	✓	114	N626A	143TTWR6028	✓	108	N757	056T34V99015	✓	118
N417	056T17WD5328	✓	112	N484	145TTWD14005	✓	114	N627	056T17W5341	✓	108	N758	056T17V99014	✓	118
N418	SEE N418A		112	N485	145TTWD14004	✓	114	N628	056T17W5334	✓	108	N760	056T34V99016	✓	118
N418A	145TTWD6029	✓	112	N486	184TTWD14002	✓	114	N629	145TTVR5030	✓	108	N761	056T17V99013	✓	118
N419	056T17WD5336	✓	112	N494	056T17WD5338	✓	112	N630	145TTWR6033	✓	108	N763	143TTWD16003	✓	118
N426	056T11VD5378	✓	111	N495	056T11VD5385	✓	112	N631	056T34W99002	✓	108	N765	056T17W99010	✓	118
N427	056T11VD5379	✓	111	N496	056T17WD5337	✓	112	N632	056T17W99005	✓	108	N766	143TTWD16032	✓	118
N428	056T17VD5332	✓	111	N497	056T11VD5386	✓	112	N633	056T17W99004	✓	108	N768	145TTWD16005	✓	118
N429	056T11VD5379	✓	111	N498	056T11VD5387	✓	112	N634	182TTWW16002	✓	108	N770	056T17W99008	✓	118
N430	056T17VD5329	✓	111	N499	145TTWD6077	✓	112	N635	184TTWW16002	✓	108	N771	145TTWD16031	✓	118
N431	056T17VD5330	✓	111	N523	056C17W5327	✓	105	N637	215TTWW16003	✓	108	N1314	SEE N314B		106
N432	056T17VD5331	✓	111	N524	056C34W5303	✓	105	N640	056T17V5326	✓	107	N1315	SEE N315A		106
N433	056T17VD5330	✓	111	N525	056C17W5328	✓	105	N641	056T17V5327	✓	107	N1316	SEE N316B		106
N434	SEE N434A		111	N526	056C34W5304	✓	105	N642	056T17V5328	✓	107	N1317	SEE N317A		106
N434A	143TTWD4527	✓	111	N527	056C17W5329	✓	105	N643	056T34V5301	✓	107	N1614	SEE N614B		108
N435	056T17WD5331	✓	111	N528	056C34W5305	✓	105	N644	056T17V5329	✓	107	N1615	SEE N615B		108
N436	SEE N436A		111	N529	056C17W5330	✓	105	N645	056T34V5302	✓	107	N1616	SEE N616B		108
N436A	145TTWD6031	✓	111	N530	056C34W5301	✓	105	N646	056T17V5330	✓	107	N1656	SEE N656B		107
N437	056T17WD5332	✓	111	N531	056C17W5326	✓	105	N647	143TTVR5326	✓	107	N1657	SEE N657B		107
N438	SEE N438A		111	N532	056C34W5302	✓	105	N648	056T34V5303	✓	107	N1658	SEE N658B		107
N438A	145TTWD4528	✓	111	N540	056C34W5308	✓	105	N649	056T17V5331	✓	107	O002	048S17525	✓	175
N439	SEE N439A		115	N541	056C17W5333	✓	105	N650	143TTVR5327	✓	107	O003	048S17524	✓	175
N439A	056T34V5314	✓	115	N542	056C34W5309	✓	105	N651	056T34V5304	✓	107	O004	048S34S2003	✓	175
N440	SEE N440A		115	N543	056C17W5334	✓	105	N652	145TTVR5301	✓	107	O005	048S34S2004	✓	175
N440A	056T34V5312	✓	115	N544	056C34W5310	✓	105	N653	056T17W5326	✓	107	O010	048C34D2024	✓	175
N441	SEE N441A		115	N545	056C17W5335	✓	105	N654	SEE N654A		107	O011	048C34D2028	✓	175
N441A	056T34V5315	✓	115	N546	056C34W99003	✓	105	N654A	145TTWR4326	✓	107	O012	048C34S24	✓	175
N442	SEE N442A		115	N556	056C34W5306	✓	105	N655	145TTWR5301	✓	107	O013	048C34S2001		175
N442A	143TTWD16002	✓	115	N557	056C17W5331	✓	105	N655A	145TTWR4301	✓	107	O014	SEE O010		175
N443	SEE N443A		115	N558	056C34W5307	✓	105	N656	SEE N656B		107	O100	048S34S361	✓	175
N443A	145TTWD16003	✓	115	N559	056C17W5332	✓	105	N656B	182TTWW4028	✓	107	O102	048S34S2005	✓	175
N444	145TTWD16002	✓	115	N564	056T17V5332	✓	108	N657	SEE N657B		107	O200	056S34D2000	✓	176

CAT. NO.	MODEL NO.	STOCK	PAGE NO.	CAT. NO.	MODEL NO.	STOCK	PAGE NO.	CAT. NO.	MODEL NO.	STOCK	PAGE NO.	CAT. NO.	MODEL NO.	STOCK	PAGE NO.
O201	056S34D93	✓	176	R316A	090ST17FH6326	✓	94	R352	SEE R352A		95	R419A	090LT17FH6327	✓	94
O210	056C34D2114	✓	176	R317	100LTC6586	✓	94	R352A	100LTC6536	✓	95	R420A	100LTC6577	✓	94
O211	056C34D2109	✓	176	R318	SEE R318A		94	R353	SEE R353A		95	R421	SEE R421A		95
O212	056C34D2098	✓	176	R318A	090ST34FH6301	✓	94	R353A	132STFC6586	✓	95	R421A	090LT34FH6302	✓	95
O213	056C34D2099	✓	176	R319	SEE R319A		94	R360	063T34FH5401	✓	96	R422A	100LTC6527	✓	95
O214	056C34D2104	✓	176	R319A	090LT17FH6326	✓	94	R361	063T17FH5402	✓	96	R424	SEE R424A		95
O215	056C34D2112	✓	176	R320	SEE R320A		94	R362	071T11FH5403	✓	96	R424A	112MTFC6512	✓	95
O217	056C34D2105	✓	176	R320A	100LTC6576	✓	94	R363	063T34FH5404	✓	96	R425	SEE R425A		95
O231	056B34D2028	✓	176	R321	SEE R321A		95	R364	071T17FH5405	✓	96	R425A	112MTFC6537	✓	95
O232	056B34D5337		176	R321A	090LT34FH6301	✓	95	R365	080T11FH5406	✓	96	R427A	132STFC6503	✓	95
O600	048S17T286	✓	175	R322	SEE R322A		95	R366	071T34FH5407	✓	96	R428	SEE R428A		95
O601	048S17T290	✓	175	R322A	100LTC6526	✓	95	R367	071T17FH5408	✓	96	R428A	132STFC6527	✓	95
O701	048A34SU1001	✓	175	R323	SEE R323A		95	R368	080T11FH5409	✓	96	R430A	132STFC6504	✓	95
P001	SEE KG215		40,122,176	R323A	112MTFC6576	✓	95	R369	071T34FH5410	✓	96	R431	SEE R431A		95
P002	SEE K216		40,122,176	R324	SEE R324A		95	R370	080T17FH5411	✓	96	R431A	132MTFC6537	✓	95
P003	SEE K218		40,122,176	R324A	112MTFC6511	✓	95	R371	080T11FH5412	✓	96	R451	SEE R451A		95
P004	SEE K220		40,122,176	R325	SEE R325A		95	R372	080T34FH5413	✓	96	R451A	100LTC6502	✓	95
P005	SEE K222		40,122,176	R325A	112MTFC6536	✓	95	R373	080T17FH5414	✓	96	R452	SEE R452A		95
P006	SEE K224		40,122,176	R326	SEE R326A		95	R374	SEE R374A		96	R452A	100LTC6537	✓	95
P007	SEE K226		40,122,176	R326A	132MTFC6586	✓	95	R374A	090S11FH6415	✓	96	R500	225MTFC6501	✓	95
P101	056T34T5306	✓	51,123	R327	SEE R327A		95	R375	080T34FH5416	✓	96	R501	225MTFC6526	✓	95
P102	056T34F5321	✓	51,123	R327A	132STFC6501	✓	95	R376	SEE R376A		96	R502	280STFC6586	✓	95
P103	056T34F5322	✓	51,123	R328	SEE R328A		95	R376A	090S17FH6417	✓	96	R503	250MTFC6501	✓	95
P104	056T34F5323	✓	51,123	R328A	132STFC6526	✓	95	R377	SEE R377A		96	R504	250MTFC6526	✓	95
P105	056T34F5324	✓	51,123	R329	SEE R329A		95	R377A	090S34FH6418	✓	96	R505	280MTFC6588	✓	95
P106	056T34F5325	✓	51,123	R329A	132MTFC6587	✓	95	R378	SEE R378A		96	R506	280STFC6501	✓	95
P107	056T34F5326	✓	52,123	R330	SEE R330A		95	R378A	090LT17FH6419	✓	96	R507	280STFC6526	✓	95
P180	5KCP49WN9813S	✓	163	R330A	132STFC6502	✓	95	R379	SEE R379A		96	R508	315STFC6588	✓	95
P184	5KCP49UN9612S	✓	163	R331	SEE R331A		95	R379A	090LT34FH6420	✓	96	R700	071T17V5326	✓	117
P185	5KCP49UN9614S	✓	163	R331A	132MTFC6536	✓	95	R380	063T34FH5501	✓	96	R701	080T17V5326	✓	117
P190	5KCP49ZN9617T	✓	161	R332	SEE R332A		95	R381	063T17FH5502	✓	96	R702	071T17V5327	✓	117
P193	5KCP39SNB480S		163	R332A	160MTFC6586	✓	95	R382	071T11FH5503	✓	96	R703	080T17V5331	✓	117
P194	5KCP39SNB481S		163	R333	SEE R333A		95	R383	063T34FH5504	✓	96	R704	080T17W5326	✓	117
P195	5KCP39SNB482S	✓	163	R333A	160MTFC6511	✓	95	R384	071T17FH5505	✓	96	R705	090LT17W4026	✓	117
P196	5KCP39TNB763T	✓	163	R334	SEE R334A		95	R385	080T11FH5506	✓	96	R706	090LT17W4027	✓	117
P197	5KCP39UNB767T	✓	163	R334A	160MTFC6536	✓	95	R386	071T34FH5507	✓	96	R707	090LT17W4028	✓	117
P198	5KCP39UNB764T	✓	163	R335	SEE R335A		95	R387	071T17FH5508	✓	96	R710	080T17V5327	✓	117
P239	5KCP33GNA471S	✓	104	R335A	160LTC6588	✓	95	R388	080T11FH5509	✓	96	R711	080T17V5333	✓	117
P240 (GE)	SEE PG240		178	R336	SEE R336A		95	R389	071T34FH5510	✓	96	R712	080T17W5327	✓	117
P241	5KCP36RNA491S	✓	178	R336A	160MTFC6512	✓	95	R390	080T17FH5511	✓	96	R720	071T17V5328	✓	117
P243	5KCP49RN9611S	✓	163	R337	SEE R337A		95	R391	080T11FH5512	✓	96	R721	080T17V5328	✓	117
P244	5KCP49UN9613S	✓	163	R337A	160LTC6538	✓	95	R392	080T34FH5513	✓	96	R722	071T17V5329	✓	117
P245	5KCP49PN9812S	✓	163	R338	SEE R338A		95	R393	080T17FH5514	✓	96	R723	080T17V5329	✓	117
P246	5KCP49UN9811S	✓	163	R338A	180LTC6588	✓	95	R394	SEE R394A		96	R724	080T17W5328	✓	117
P247	5KCP35NNA670T	✓	190	R339	SEE R339A		95	R394A	090S11FH6515	✓	96	R730	080T17V5330	✓	117
P250	5KCP35KNB057S	✓	102	R339A	160LTC6513	✓	95	R395	080T34FH5516	✓	96	R731	080T17V5332	✓	117
P251	5KCP36NNB059S	✓	102	R340	SEE R340A		95	R396	SEE R396A		96	R732	080T17W5329	✓	117
P252 (GE)	SEE PG252		190	R340A	180MTFC6536	✓	95	R396A	090S17FH6517	✓	96	S003	048S17D2089	✓	23
P253	5KCP36NNB671U	✓	190	R341	SEE R341A		95	R397	SEE R397A		96	S006	048S17D2090	✓	23
P254	5KCP35KNB650U	✓	190	R341A	200LTC6588	✓	95	R397A	090S34FH6518	✓	96	S010	048C17D2023	✓	23
PG240	5KCP35CNA490S	✓	178	R342	SEE R342A		95	R398	SEE R398A		96	S011	048C17D2024	✓	23
PG252	5KCP36NNB670U	✓	190	R342A	180MTFC6511	✓	95	R398A	090LT17FH6519	✓	96	S012	056C17D2098	✓	23
R300	063T34FH5301	✓	94	R343	SEE R343A		95	R399	SEE R399A		96	S013	056C17D2051	✓	23
R301	063T17FH5326	✓	94	R343A	180LTC6538	✓	95	R399A	090LT34FH6520	✓	96	S014	056C17D2054	✓	23
R302	071T11FH5376	✓	94	R344	SEE R344A		95	R400	063T34FH5303	✓	94	S015	056C17D2055	✓	23
R303	063T34FH5302	✓	94	R344A	200LTC6589	✓	95	R401	063T17FH5327	✓	94	S022	056S17D2046	✓	23
R304	071T17FH5326	✓	94	R345	SEE R345A		95	R403	063T34FH5304	✓	94	S026	048S17D2113	✓	23
R305	080T11FH5376	✓	94	R345A	200LTC6511	✓	95	R404	071T17FH5330	✓	94	S027	056S17D2066	✓	23
R306	071T34FH5301	✓	94	R346	SEE R346A		95	R406	071T34FH5303	✓	94	S030	048C17D2027	✓	23
R307	071T17FH5327	✓	94	R346A	200LTC6538	✓	95	R407	071T17FH5331	✓	94	S033	056C17D2064	✓	23
R308	080T11FH5377	✓	94	R347	SEE R347A		95	R409	071T34FH5304	✓	94	S036	056C17D2067	✓	23
R309	071T34FH5302	✓	94	R347A	225MTFC6586	✓	95	R410	080T17FH5330	✓	94	S037	056C17D5319	✓	23
R310	080T17FH5326	✓	94	R348	SEE R348A		95	R412	080T34FH5305	✓	94	S038	056C17D5343	✓	23
R311	080T11FH5378	✓	94	R348A	200LTC6513	✓	95	R413	080T17FH5331	✓	94	S039	056C17D5320	✓	23
R312	080T34FH5301	✓	94	R349	SEE R349A		95	R415	080T34FH5303	✓	94	S102	048S17D2042	✓	25
R313	080T17FH5327	✓	94	R349A	225STFC6526	✓	95	R416	SEE R416A		94	S103	048S17D2091	✓	25
R314	SEE R314A		94	R350	SEE R350A		95	R416A	090S17FH6327	✓	94	S106	048S17D2093	✓	26
R314A	090ST11FH6376	✓	94	R350A	250MTFC6586	✓	95	R418	SEE R418A		94	S110	048C17D2028	✓	26
R315	080T34FH5302	✓	94	R351	SEE R351A		95	R418A	090S34FH6302	✓	94	S111	048C17D2029	✓	26
R316	SEE R316A		94	R351A	100LTC6501	✓	95	R419	SEE R419A		94	S112	056C17D2097	✓	26

Index

Catalog Number/Model Number

CAT. NO.	MODEL NO.	STOCK	PAGE NO.	CAT. NO.	MODEL NO.	STOCK	PAGE NO.	CAT. NO.	MODEL NO.	STOCK	PAGE NO.	CAT. NO.	MODEL NO.	STOCK	PAGE NO.
S113	056C17D2099	✓	26	U008	SEE E503		80	U060A	182TTGN6501	✓	79	U120	326TDP4329		127
S114	056C17D2060	✓	26	U009	SEE E506		80	U061	SEE U061A		79	U121	326TDP4326		127
S115	056C17D2061	✓	26	U010	SEE E547		80	U061A	184TTGN6501	✓	79	U122	143TTDR4024		135
S116	056C17D5339	✓	26	U011	SEE E564		80	U062	SEE U062A		80	U123	SEE U123A		135
S117	056C17D5340	✓	26	U012	SEE E567		80	U062A	213TTGN6501	✓	80	U123A	143TTDR14048		135
S118	048C17D2045	✓	25	U013	SEE E570		80	U063	SEE U063A		80	U124	143TTDR4048		135
S119	048C17D2046	✓	25	U018	SEE E585		81	U063A	215TTGN6501	✓	80	U125	143TTDR4043		135
S120	056S17D2023	✓	26	U019	SEE E588		81	U064	SEE E502		80	U126	143TTDR4037		135
S126	048S17D2104	✓	25	U020	143TTGN4030		78	U065	SEE E505		80	U127	143TTDR4049		135
S127	048S17D2105	✓	26	U020A	143TTGN6530	✓	79	U066	SEE E546		80	U128	143TTDR4018		135
S128	048S17D2106	✓	26	U021	145TTGN4035		78	U067	SEE E563		80	U129	SEE U129A		135
S501	145TTTN18577		191	U021A	145TTGN6537	✓	79	U068	SEE E566		80	U129A	143TTDR14003	✓	135
S503	145TTTN18531		191	U022	145TTGN4040		78	U069	SEE E569		80	U130	143TTDR4023		135
S504	184TTTS18577		191	U022A	145TTGN6540	✓	79	U070	SEE E572		80	U131	143TTDR4019		135
S506	182TTTS18532		191	U023	182TTGS4030		78	U071	SEE E575		81	U132	143TTDR4011		135
S507	213TTTS17077		191	U023A	182TTGN6530	✓	79	U073	SEE U073A		81	U133	143TTDR4025		135
S510	215TTTS17077	✓	191	U024	184TTGS4030		78	U073A	444TTSTGN16502		81	U134	145TTDR4042		135
S513	254TTTNA17077	✓	191	U024A	184TTGN6530	✓	79	U074	SEE E584		81	U135	SEE U135A		135
S516	256TTTNA18578	✓	191	U025	213TTGS4030		78	U075	SEE U075A		81	U135A	145TTDR4354	✓	135
S517	284TTTNA18601		191	U025A	213TTGN16537	✓	80	U075A	445TTSTGN16506		81	U136	145TTDR4048		135
S518	254TTTNA18530		191	U026	215TTGS4030		78	U076	SEE U076A		80	U137	145TTDR4043		135
S519	284TTTNA16577		191	U026A	215TTGN16532	✓	80	U076A	284TTSTGN16531		80	U138	145TTDR4037		135
S522	286TTTNA18577		191	U027	254TTGN4030		78	U077	SEE U077A		80	U139	145TTDR4049		135
S523	324TTTS18601		191	U027A	254TTGN16541	✓	80	U077A	286TTSTGN16531		80	U140	145TTDR4017		135
S525	324TTTS18577		191	U028	256TTGN4030		78	U078	SEE U078A		80	U141	145TTDR4011		135
S528	326TTTS18577		191	U028A	256TTGN16540	✓	80	U078A	324TTSTGS16531		80	U142	145TTDR4023		135
S553	145TTTN18532		191	U029	284TTGP4030		78	U079	SEE U079A		80	U143	145TTDR4018		135
S554	184TTTS18578		191	U029A	284TTGN16539	✓	80	U079A	326TTSTGS16532		80	U144	145TTDR4012		135
S557	213TTTS17078		191	U030	286TTGP4030		78	U080	SEE U080A		80	U145	145TTDR4024		135
S560	215TTTS17078	✓	191	U030A	286TTGN16533	✓	80	U080A	364TTSTGS16531		80	U146	145TTDR4068		135
S564	256TTTNA18601		191	U031	324TTGP4030		78	U081	SEE U081A		81	U147	SEE U147A		135
S566	256TTTNA18577		191	U031A	324TTGS16535	✓	80	U081A	365TTSTGS16532		81	U147A	145TTDR4356	✓	135
S567	284TTTNA17101	✓	191	U032	326TTGP4030		78	U082	SEE U082A		81	U148	145TTDR4074		135
S569	284TTTNA18577		191	U032A	326TTGS16539	✓	80	U082A	405TTSTGS16531		81	U149	145TTDR4069		135
SY001	056PNRA10100	✓	91	U033	364TTGS4040		78	U083	SEE U083A		81	U150	SEE U150A		135
SY003	056PNRA10101	✓	91	U033A	364TTGS16537	✓	80	U083A	444TTSTGN16531		81	U150A	145TTDR4355		135
SY004	056PNRA10102	✓	91	U034	365TTGS4040		78	U084	SEE U084A		81	U151	145TTDR4075		135
SY005	056PNRA10103	✓	91	U034A	365TTGS16542	✓	81	U084A	445TTSTGN16531		81	U152	145TTDR4117		135
SY006	182TPFSA10094	✓	91	U035	405TTGS4040		78	U085	SEE E582A		81	U153	145TTDR4111	✓	135
SY007	184TPFSA10095	✓	91	U035A	405TTGS16539	✓	81	U088	SEE E577		81	U154	145TTDR4123		135
SY008	213TPFSA10096	✓	91	U036	444TTGS4042		78	U089	SEE E574		80	U155	145TTDR4118		135
SY009	215TPFSA10097	✓	91	U036A	444TTGN16533	✓	81	U090	SEE U090A		81	U156	145TTDR4112		135
SY010	254TPFSA10088	✓	91	U037	445TTGN4030		78	U090A	445TTGN16588	✓	81	U157	145TTDR4124		135
SY011	256TPFSA10087	✓	91	U037A	445TTGN16544	✓	81	U091	SEE U091A		81	U158	182TTDR4142		135
SY012	284TPFSA10112	✓	91	U038	445TTGN4045		78	U091A	449TTGS16585		81	U159	SEE U159A		135
SY013	286TPFSA10090	✓	91	U038A	445TTGN16543	✓	81	U092	SEE E571		80	U159A	182TTDW4338	✓	135
T010	056C17F5351	✓	195	U039	SEE U039A		79	U093	SEE E573A		80	U160	182TTDR4148		136
T013	056C34F5340	✓	195	U039A	145TTGN6576	✓	79	U094	SEE E576A		81	U161	182TTDR4143		135
T014	056C17F5350	✓	195	U040	SEE U040A		79	U095	SEE E850A		81	U162	SEE U162A		135
T015	056C34F5339	✓	195	U040A	182TTGN6576	✓	79	U096	SEE E578		81	U162A	182TTDW4339		135
T016	056C17F5349	✓	195	U041	SEE U041A		79	U097	SEE E594		81	U163	182TTDR4149		136
T017	056B34F5332	✓	195	U041A	184TTGN6576	✓	79	U100	256TTDX4041		127	U164	182TTDR4118		136
T018	056B17F5328	✓	195	U042	SEE U042		79	U101	256TTDX4047		127	U165	SEE U165A		136
T019	056B34F5333	✓	195	U042A	213TTGN6576	✓	79	U102	256TTDX4021		127	U165A	182TTDW14011	✓	136
T030	056B17F5329	✓	195	U043	SEE U043A		79	U103	256TTDX4006	✓	127	U166	182TTDR4124		136
T031	145TBFRS309	✓	195	U043A	215TTGN6576	✓	79	U104	256TTDX4019		127	U167	182TTDR4119		136
U001	SEE U001A		79	U044	SEE E500		80	U105	284TTDP4043		127	U168	182TTDR4113		136
U001A	143TTGN6526	✓	79	U045	SEE E501		80	U106	284TTDP4069	✓	127	U169	182TTDR4125		136
U002	SEE U002A		79	U046	SEE E504		80	U107	284TTDP4037		127	U170	184TTDR4142		136
U002A	145TTGN6526	✓	79	U047	SEE E507		80	U108	284TTDP4025		127	U171	SEE U171A		136
U003	SEE U003A		79	U048	SEE U048A		80	U109A	284TTDP14009	✓	127	U171A	184TTDW4136		136
U003A	145TTGN6527	✓	79	U048A	324TTGS16577	✓	80	U110	284TTDP4023		127	U172	184TTDR4148		136
U004	SEE U004A		79	U049	SEE E565		80	U111	286TTDP4067		127	U173	184TTDR4143		136
U004A	182TTGN6526	✓	79	U050	SEE E568A		80	U112	286TTDP4037		127	U175	184TTDR4149		136
U005	SEE U005A		79	U055	SEE E583		81	U113	286TTDP4047		127	U176	184TTDR4117		136
U005A	184TTGN6526	✓	79	U058	SEE U058A		79	U114	286TTDP4015	✓	127	U177	SEE U177A		136
U006	SEE U006A		80	U058A	143TTGN6501	✓	79	U115	286TTDP4021		127	U177A	184TTDW14079	✓	136
U006A	213TTGN6526	✓	80	U059	SEE U059A		79	U116	324TTDP4345		127	U178	184TTDR4123		136
U007	SEE U007A		80	U059A	145TTGN6501	✓	79	U118	324TTDP4004	✓	127	U179	184TTDR4118		136
U007A	215TTGN6526	✓	80	U060	SEE U060A		79	U119	324TTDP4018		127	U180	184TTDR4112		136

Catalog Number/Model Number

CAT. NO.	MODEL NO.	STOCK	PAGE NO.	CAT. NO.	MODEL NO.	STOCK	PAGE NO.	CAT. NO.	MODEL NO.	STOCK	PAGE NO.	CAT. NO.	MODEL NO.	STOCK	PAGE NO.
U181	184TTDR4124		136	U247	145TTDR6002	✓	42	U331	213TTFW4010		131	U430A-P	284TTDR16047	✓	43
U182	213TTDW4044		136	U249A	184TTDW6001	✓	43	U332	213TTFW4012		137	U431A-P	215TTDW16073	✓	43
U183	213TTDW4049	✓	136	U250	404TSTDS6001	✓	44	U334	213TTFW4047	✓	131	U432	SEE U432A		41
U184	213TTDW4039		136	U251	405TSTDS6007	✓	44	U335	213TTFW4038		131	U432A	213TTDW16010		41
U185	213TTDW4051		136	U252	444TSTDS16003	✓	44	U336	215TTFW4014		131	U433	SEE U433A		41
U186	SEE U186A		136	U254	SEE GT0017		43	U337	215TTFW4022	✓	131	U433A	215TTDW16061		41
U186A	213TTDW14059		136	U255	SEE GT0020		43	U338	215TTFW4015		131	U435	215TTDW4315		41
U187	213TTDW4052		136	U256	284TTDC6076	✓	43	U339	215TTFW4035		131	U436	SEE U436A		41
U188	213TTDW4011		136	U257	SEE GT0028		43	U340	215TTFW4047	✓	131	U436A	254TTDN16056	✓	41
U189	SEE U189A		136	U265	145TTDR6076	✓	42	U341	215TTFW4036		131	U437	254TTDX4315		41
U189A	213TTDW14013	✓	136	U268	213TTDC6076	✓	42	U343	254TFL4009		137	U438	SEE U438A		41
U190	213TTDW4012		136	U269	215TTDC6076	✓	43	U344	254TFL4006	✓	131	U438A	256TTDN16049		41
U191	213TTDW4013		136	U270	404TTDS6086	✓	44	U345	SEE U345A		137	U439	SEE U439A		41
U192	213TTDW4025		136	U271	405TTDS16081	✓	44	U345A	254TFL14008	✓	137	U439A	256TTDN16009		41
U193	213TTDW4014		136	U272	444TTDS16077	✓	44	U346	254TFL4010		131	U440	SEE U440A		41
U194	215TTDW4044		136	U273	445TTDS16076	✓	44	U347	254TFL4034		131	U440A	286TSTDN16034		41
U195	215TTDW4049	✓	136	U274	447TTDN16077	✓	44	U348	254TFL4031	✓	131	U441	SEE U441A		41
U196	215TTDW4051		136	U275	449TTDN16076	✓	44	U349	254TFL4036		131	U441A	286TSTDN16005	✓	41
U197	215TTDW4053		136	U279	213TTDC6079	✓	42	U350	256TFL4010		131	U442	SEE U442A		41
U198	SEE U198A		136	U280	215TTDC6079	✓	43	U351	256TFL4006	✓	131	U442A	286TSTDN16033		41
U198A	215TTDW14073		136	U281	213TTDC6029	✓	43	U352	256TFL4012		131	U443	SEE U443A		41
U199	215TTDW4052		136	U282	254TTDC6079	✓	43	U353	256TFL4036		131	U443A	286TSTDN16004	✓	41
U200	215TTDW4011		136	U283	213TTDC6003	✓	43	U354	256TFL4031	✓	131	U444	SEE U444A		41
U201	SEE U201A		136	U284	215TTDC6029	✓	43	U355	256TFL4038		131	U444A	324TSTDP16032		41
U201A	215TTDW14020	✓	136	U285	256TTDC6079	✓	43	U356	254TFL4011		137	U445	SEE U445A		41
U202	215TTDW4012		136	U286	215TTDC6003	✓	43	U357	215TTFW14301	✓	131	U445A	324TSTDP16002	✓	41
U203	215TTDW4013		136	U287	254TTDC6029	✓	43	U360	184TTFW4915	✓	131	U446	SEE U446A		41
U204	215TTDW4025		136	U288	284TTDC6079	✓	43	U363	145TTFR4310	✓	131	U446A	326TSTDR16035		41
U205	215TTDW4014		136	U289	254TTDC6003	✓	43	U366	215TTFW14302		137	U447	SEE U447A		41
U206	254TTDX4074		136	U290	256TTDC6029	✓	43	U372	184TTFW4914	✓	137	U447A	326TSTDP16005		41
U207	254TTDX4075	✓	136	U291	256TTDC6003	✓	43	U400	SEE U400A		44	U448	SEE U448A		41
U208	254TTDX4340		136	U292	284TSTDC6003	✓	43	U400A	445TSTDS16038	✓	44	U448A	365TSTDS16044		41
U209	254TTDX4060		136	U293	286TSTDC6003	✓	44	U401A	145TTDR16308	✓	41	U449	SEE U449A		41
U210	254TTDX4041	✓	136	U294	324TSTDC6003	✓	44	U402	SEE U402C		41	U449A	365TSTDS16008		41
U211	254TTDX4341		136	U299	184TTDW4039		136	U402B	SEE U402C		41	U450	SEE U450A		41
U212	254TTDX4014		137	U300	143TTFR4040		130	U402C	182TTDW16010	✓	41	U450A	365TSTDS6074		41
U213	254TTDX4017	✓	137	U301	143TTFR4034	✓	130	U403	SEE U403A		41	U451	SEE U451A		41
U214	254TTDX4008		137	U302	143TTFR4046		130	U403A	184TTDW16043		41	U451A	365TSTDS16005		41
U215	254TTDX4010		137	U303	143TTFR4015		130	U404	SEE U404B		41	U452	SEE U452A		41
U216	254TTDX4012		137	U304	SEE U304A		130	U404B	184TTDW16001	✓	41	U452A	404TSTDS6327		41
U217	254TTDX4016		137	U304A	143TTFR4303	✓	130	U405	SEE U405A		41	U453	SEE U453A		41
U218	256TTDX4064		137	U305	143TTFR4021		130	U405A	213TTDW16063	✓	41	U453A	404TSTDS16006	✓	41
U219	256TTDX4063	✓	137	U306	145TTFR4048		130	U410A	182TTDW16059	✓	41	U454A	405TSTDS16039		41
U220	256TTDX4328		137	U307	145TTFR4045	✓	130	U416	143TTDR4061		36	U455	SEE U455A		41
U221	256TTDX4065		137	U308	145TTFR4054		130	U417	SEE U417A		37	U455A	405TSTDS16005		41
U223	256TTDX4059		137	U309	145TTFR4017		130	U417A	143TTDR6052	✓	37	U456	SEE U456A		41
U224	256TTDX4022		137	U310	SEE U310A		130	U418	SEE U418A		37	U456A	444TSTDS16034		41
U225	256TTDX4004	✓	137	U310A	145TTFR14011	✓	130	U418A	143TTDR6051	✓	37	U500	256TTDX4024		144
U226	256TTDX4023		137	U311	145TTFR4023		130	U419	145TTDR4128		37	U501	256TTDX4020		144
U227	284TTP4044		137	U312	145TTFR4050		130	U420	SEE U420A		37	U502	284TTP4027		144
U228	SEE U228A		137	U313	SEE U313A		130	U420A	145TTDR6126	✓	37	U503	284TTP4047		144
U228A	284TTP14044	✓	137	U313A	145TTFR14045	✓	130	U421	SEE U421A		37	U504	284TSTDP4002	✓	144
U229	284TTP4045		137	U314	145TTFR4128		130	U421A	145TTDR6127		37	U505	284TSTDP14007		144
U230	284TTP4011		137	U315	182TTFR4015		131	U422	145TTDR4134	✓	37	U506	286TTP4041		144
U231	284TTP4022	✓	137	U316	SEE U316A		131	U423	SEE U423A		37	U507	286TTP14042		144
U232	284TTP4012		137	U316A	182TTFW4302	✓	131	U423A	145TTDR6132	✓	37	U508	286TSTDP4022	✓	144
U233	286TTP4048		137	U317	182TTFR4021		131	U424	SEE U424A		37	U509	286TSTDP4023	✓	144
U234	286TTP4074	✓	137	U319	SEE U319A		131	U424A	145TTDR6133	✓	37	U510	324TTP4038		144
U235	286TTP4049		137	U319A	182TTFW4330	✓	131	U425	SEE U1425		38	U511	324TTP14049		144
U236	286TTP4020	✓	137	U320	182TTFR4056		131	U425B	182TTDW16048		38	U512	324TSTDP4010	✓	144
U237	286TTP4024		137	U322A	184TTFW4009	✓	131	U426	SEE U426B		38	U513	324TSTDP4007	✓	144
U238	324TTP4348	✓	137	U323	184TTFR4021		131	U426B	182TTDW16049	✓	38	U514	326TTP4345		144
U239	324TTP4033		137	U325	SEE U325A		131	U427	184TTDR4153	✓	38	U515	326TTP4344		144
U240	324TTP4002	✓	137	U325A	184TTFW4760	✓	131	U427A	184TTDW4153	✓	38	U516	326TSTDP4024	✓	144
U241	324TTP4011		137	U326	SEE U326A		131	U428	SEE U428B		38	U517	326TSTDP4022	✓	144
U242	326TTP4340	✓	137	U326A	184TTFW14028		131	U428A	SEE U428B		38	U518	364TSTDS4332	✓	144
U243	326TTP4032		137	U327	213TTFW4009		131	U428B	184TTDW16038	✓	38	U519	364TSTDS4337		144
U244	056T34D6001	✓	42	U328	213TTFW4011		137	U429	213TTDW4070		38	U520	364TTDS4328		144
U245	143TTDR6028	✓	42	U329	213TTFW4022	✓	131	U430	SEE U430A		38	U521	326TSTDR14034		144
U246	145TTDR6039	✓	42	U330	SEE U372		137	U430A	213TTDW16060	✓	38	U522	364TSTDS4025	✓	145

Index

Catalog Number/Model Number

CAT. NO.	MODEL NO.	STOCK	PAGE NO.	CAT. NO.	MODEL NO.	STOCK	PAGE NO.	CAT. NO.	MODEL NO.	STOCK	PAGE NO.	CAT. NO.	MODEL NO.	STOCK	PAGE NO.
U523	364TSTDS4024	✓	145	U639A	215TFC6027	✓	58	U740	213TTFW4007		55	U877	SEE U877A		65
U524	365TSTDS4332	✓	145	U640	215TTFW4030		48	U741	SEE GT1215		64	U877A	364TTF516558	✓	65
U525	365TSTDS4347		145	U641	215TTF54030		49	U742	213TTFW4008		55	U878	SEE U878A		65
U526	365TSTDS4025	✓	145	U641A	215TFC6031	✓	58	U743	215TTFW4013		55	U878A	365TTF516827	✓	65
U527	365TSTDS4303	✓	145	U642	SEE U642A		58	U744	SEE GT1218		64	U879	SEE U879A		65
U528	404TSTDS4332	✓	145	U642A	256TFC6077	✓	58	U746	SEE GT1221		64	U879A	405TTF516834	✓	65
U529	404TSTDS4333	✓	145	U643	254TFL14004		48	U748	SEE GT1224		64	U880	SEE U880A		65
U530	404TSTDS4017	✓	145	U644	SEE GT1021		61	U749	SEE GT1227		64	U880A	444TTFN16549	✓	65
U531	404TSTDS14008	✓	145	U644A	SEE GT1021		61	U750	SEE GT1230		64	U881	SEE U881A		65
U532	405TSTDS4332	✓	145	U645	254TFL14005		48	U757	SEE GT1220		64	U881A	445TTFN16866		65
U533	405TSTDS4333		145	U646	SEE U646A		48	U758	143TDR6027	✓	42	U882	SEE U882A		65
U534	405TSTDS4006	✓	145	U646A	254TFL4027	✓	48	U758-P	143TDR16052	✓	42	U882A	445TTFN16852		65
U535	444TSTDS4332	✓	145	U647	SEE U647B		58	U759	145TDR6028	✓	42	U884	445TTFN4575		65
U536	444TSTDS4010	✓	145	U647B	254TFC6027	✓	58	U759-P	145TDR16348	✓	42	U900	254TDX4018		38
U537	445TSTDS4332	✓	145	U648	254TTFNA4030		49	U760	145TDR6029	✓	42	U901	284TSDP4004		39
U538	364TSDS14329		144	U648A	254TFC6031	✓	58	U760-P	145TDR16349	✓	42	U902	286TSDP4017		39
U539	445TSTDS14007	✓	145	U649	SEE U649A		58	U763	213TDC6026	✓	43	U903	404TDS4042		39
U540	445TSTDS14051	✓	145	U649A	256TFC6002	✓	58	U764	213TDC6001	✓	43	U903A	404TDS16055		44
U601	145TTN4032		49	U650	256TTFNA4005		50	U765	215TDC6026	✓	43	U904	405TDS4049		39
U602	SEE GT1009		61	U650A	SEE GT1124		62	U766	215TDC6001	✓	43	U904A	405TDS16060		44
U602A	SEE GT1009		61	U651	256TFL14027		48	U767	254TDC6026	✓	43	U905	145TDR4103		37
U603	SEE E2134		57	U652	SEE U652B		58	U768	254TDC6001	✓	43	U906	145TDR4005		37
U604	182TTF54005		49	U652B	256TFC6027	✓	58	U769	256TDC6026	✓	43	U906A	145TDR16008	✓	42
U604A	SEE GT1109		61	U653	256TTFNA4030		50	U770	SEE GT0027		45	U907	213TDDW4078	✓	38
U605	SEE U605A		48	U653A	256TFC6031	✓	58	U771	284TDC6026	✓	43	U908	182TDR4106		38
U605A	182TTFW4327	✓	48	U654	284TTFPA4005		50	U772	SEE GT0030		45	U908A	182TDDW16008	✓	43
U606	145TTN4030		49	U654A	SEE GT1127		62	U773	286TDC6026	✓	43	U909	324TSDP4006		38
U607	SEE GT1010		61	U655	284TTFPA4028		50	U774	SEE GT0033		45	U910	326TSDP4003		39
U607A	SEE GT1010		61	U659	326TTFPA4030		50	U775	SEE GT0034		45	U911	444TDS4069		39
U608	SEE U1608		48	U659A	326TFC6031	✓	59	U775-P	324TDR16050	✓	44	U911A	444TDS16043		44
U609	SEE U609A		57	U660	364TTF54040		50	U776	SEE GT0036		45	U912	445TDS4070		39
U609A	182TFC6031	✓	57	U660A	SEE GT1140		62	U777	326TDC6026	✓	44	U912A	445TDS16041		44
U610	SEE GT1011		61	U661	SEE E314		59	U778	SEE GT0039		45	U914	182TDDW16009	✓	42
U610A	SEE GT1011		61	U662	SEE E316A		60	U785	447TSDN16004	✓	44	U915	184TDDW16076	✓	42
U611	184TFR4003		48	U663	SEE E246		60	U786	447TDDN16046	✓	44	U917	184TDDW16041		38
U613	SEE GT1012		61	U667	SEE E326		60	U788	447TSDN16007	✓	44	U922	143TDR4055		37
U613A	SEE GT1012		61	U669	SEE U669A		60	U789	447TDDN16041		44	U922A	143TDR16036		37
U614	184TFR4005		48	U669A	445TTFN6028		60	U790	449TDDN16077		44	U923	145TDR4130		37
U615	184TTF54005		49	U670	SEE E2121		58	U791	447TSDN16008	✓	44	U923A	145TDR16054		37
U615A	184TFC6006	✓	57	U671	213TTF54005		49	U793	449TSDN16003	✓	44	U924	145TDR4136		37
U616	184TFR4038	✓	48	U671A	213TFC6006	✓	57	U795	449TSDN16004	✓	44	U924A	145TDR16059		37
U616A	184TTFW4727	✓	48	U672	145TTN4080	✓	49	U797	449TSDN16005	✓	44	U925	182TDR4075		38
U618	SEE U618A		57	U701	SEE GT1201		63	U798	324TDC6076	✓	43	U925A	182TDDW16082		38
U618A	184TFC6027	✓	57	U703	145TFR4046		54	U799	SEE GT032		45	U926	213TDDW4071		38
U619	SEE U1619		48	U704	SEE GT1204		63	U815	SEE GT1224		64	U926A	213TDDW16061		38
U620	184TTF54030		49	U705	145TFR4052		54	U830	SEE GT1233		64	U930	SEE U001A		79
U620A	184TFC6031	✓	57	U706	145TFR4070		54	U834	SEE GT1236		64	U931	SEE U039A		79
U621	SEE U621A		57	U707	SEE GT1207		63	U838	SEE GT1239		64	U933	SEE U002A		79
U621A	215TFC6077	✓	57	U708	145TFR4126		54	U842	SEE GT1242		64	U934	SEE U040A		79
U622	213TTFW4003		48	U710	SEE GT1210		64	U845	SEE GT1245		64	U935	SEE U059A		79
U624	SEE GT1015		61	U713	SEE GT1213		64	U867	SEE U867A		65	U936	SEE U003A		79
U624A	SEE GT1015		61	U716	SEE GT1216		64	U867A	182TTFN6557		65	U937	SEE U041A		79
U625	213TTFW4005		48	U718	215TTFW4033		55	U868	SEE U868A		65	U938	SEE U060A		79
U627	213TTFW4028	✓	48	U721	254TFL4033		55	U868A	184TTFN6555	✓	65	U939	SEE U004A		79
U629	SEE U629A		57	U722	SEE GT1222		64	U869	SEE U869A		65	U940	SEE U042A		79
U629A	213TFC6027	✓	57	U723	254TFL4035		55	U869A	213TTFN6550	✓	65	U941	SEE U061A		79
U630	213TTFW4030		48	U724	SEE GT1225		64	U870	SEE U870A		65	U942	SEE U005A		79
U631	213TTF54030		49	U725	SEE GT1228		64	U870A	215TTFN6546	✓	65	U943	SEE U043A		79
U631A	213TFC6031	✓	57	U726	SEE GT1231		64	U871	SEE U871A		65	U944	SEE U062A		80
U632	SEE E2117		57	U727	SEE GT1234		64	U871A	254TTFNA16568	✓	65	U945	SEE U006A		80
U633	SEE U633A		57	U728	SEE GT1237		64	U872	SEE U872A		65	U946	SEE E500		80
U633A	254TFC6077	✓	57	U729	SEE GT1240		64	U872A	256TTFNA16574	✓	65	U947	SEE U063A		80
U634	215TTFW4003		48	U730	SEE GT1243		64	U873	SEE U873A		65	U948	SEE U007A		80
U636	SEE U636A		58	U731	SEE GT1246		64	U873A	284TTFNA16832	✓	65	U949	SEE E501		80
U636A	215TFC6002	✓	58	U733	SEE GT1203		63	U874	SEE U874A		65	U950	SEE E502		80
U637	215TTF54005		49	U735	SEE GT1206		63	U874A	286TTFNA16572	✓	65	U951	SEE E503		80
U637A	SEE GT1118		61	U736	182TFR4013		54	U875	SEE U875A		65	U952	SEE E504		80
U638	254TTFPA4005		49	U737	SEE GT1209		64	U875A	324TTF516837	✓	65	U953	SEE E505		80
U638A	254TFC6006	✓	58	U738	184TFR4013		54	U876	SEE U876A		65	U954	SEE E506		80
U639	SEE U639A		58	U739	SEE GT1212		64	U876A	326TTF516574	✓	65	U955	SEE E507		80

Catalog Number/Model Number

CAT. NO.	MODEL NO.	STOCK	PAGE NO.	CAT. NO.	MODEL NO.	STOCK	PAGE NO.	CAT. NO.	MODEL NO.	STOCK	PAGE NO.	CAT. NO.	MODEL NO.	STOCK	PAGE NO.
U956	SEE E546		80	W509	182THS9076		71	W582A	365THFS19086	✓	73	X013	048A17O152	✓	166
U957	SEE E547		80	W511	145THTN9001		71	W583	404THFS9101		73	X014	048A17O154	✓	166
U958	SEE U048A		80	W512	145THTN19002		71	W584	364THFS9001	✓	73	X015	048A17O151	✓	166
U959	SEE E563		80	W513	145THTN9027	✓	71	W586	364THFS9026	✓	73	X016	048A17O153	✓	166
U960	SEE E564		80	W514	145THTN19033		71	W587	364THFS9036	✓	73	X017	048A17O155	✓	166
U961	SEE E565		80	W515	184THS9076		71	W587-P	364THFS19061	✓	73	X018	048A11O1350	✓	166
U962	SEE E566		80	W517	182THS9001		72	W588	364THFS19033		73	X019	048A11O1351	✓	166
U963	SEE E567		80	W519	182THS9026	✓	72	W589	404THFS9086		73	X020	048A11O1352	✓	166
U964	SEE E568A		80	W520	182THS19033		72	W590	405THFS19101		73	X021	048A11O1353	✓	166
U965	SEE E569		80	W521	213THFS9076	✓	72	W591	365THFS9001	✓	73	X022	048A17O174	✓	166
U966	SEE E570		80	W522	215THFS9101		72	W592	365THFS19002		73	X023	048A11O1583	✓	166
U967	SEE E571		80	W523	184THFS9001	✓	72	W593	SEE W593A		73	X024	048A17T2002	✓	101
U968	SEE E572		80	W524	184THFS19006		72	W593A	365THFS19034		73	X025	048A17T2003	✓	101
U969	SEE E573A		80	W525	184THFS9026	✓	72	W594	365THFS9036	✓	73	X026	048A17T2004	✓	101
U970	SEE E574		80	W526	184THFS9030	✓	72	W594-P	365THFS19065	✓	73	X027	048A11T2021	✓	101
U971	SEE E575		81	W527	215THFS9076	✓	72	W595	365THFS9044	✓	73	X028	048A11T2022	✓	101
U972	SEE E576A		81	W528	215THFS19077		72	W596	405THFS9086		73	X029	048A11T2023	✓	101
U973	SEE E577		81	W529	254THFNA9101		72	W597	444THFS9101		73	X030	048A17T118	✓	101
U974	SEE E578		81	W530	213THS9001	✓	72	W598	405THFS9001	✓	73	X031	048A17T237	✓	101
U975	SEE E594		81	W531	213THS19005		72	W599	405THFS9026		73	X032	048A17T119	✓	101
U976	SEE E580A		81	W532	213THFS9026	✓	72	W600	405THFS9036	✓	73	X033	048A11O1674	✓	166,184
U977	SEE U073A		81	W533	213THFS9030	✓	72	W600-P	405THFS19327	✓	73	X034	048A11O1773	✓	167
U978	SEE E582A		81	W534	254THFNA9076	✓	72	W601	405THFS9040	✓	73	X035	048A11O1774	✓	167
U979	SEE E583		81	W536	256THFNA9101		72	W603	445THFN9106		73	X036	048A11O1772	✓	167
U980	SEE E584		81	W537	215THFS9001	✓	72	W604	SEE W604A		73	X037	048A11O1876	✓	166
U981	SEE E585		81	W538	215THFS19006		72	W604A	444THFN19002		73	X038	048A11O1874	✓	167
U982	SEE U090A		81	W539	215THFS9026	✓	72	W606	444THFS9036	✓	73	X039	048A11O1875	✓	167
U984	SEE E588		81	W540	215THFS19033	✓	72	W606-P	444THFN19044	✓	73	X040	048A17O69	✓	168
U985	SEE U091A		81	W541	256THFNA9076	✓	72	W607	444THFS9040	✓	73	X041	048A17O70	✓	168
U986	SEE U986A		79	W542	256THFNA19081		72	W608	445THFN9086		73	X042	048A11O653	✓	168
U986A	143TTGN6532		79	W543	284THFNA19102		72	W609	445THFN9102		73	X043	048A11O654	✓	168
U987	SEE U987A		79	W544	254THFNA9001	✓	72	W610	445THFN9001		73	X044	048A11O655	✓	168
U987A	145TTGN16532		79	W546	254THFNA9026	✓	72	W611	445THFN9026	✓	73	X045	048A11O656	✓	168
U988	SEE U988A		79	W546-P	254THFNA19065	✓	72	W612	445THFN9036	✓	73	X048	048A11O772	✓	168
U988A	145TTGN6550		79	W547	254THFNA9030		72	W612-P	445THFN19071	✓	73	X049	048A11O773	✓	168
U989	SEE U989A		79	W548	284THFNA9076	✓	72	W613	445THFN9037		73	X050	048A11O774	✓	168
U989A	182TTGN6541		79	W549	284THFNA19084		72	W614	445THFN9087		73	X052	048A11O775	✓	168
U990	SEE U990A		79	W550	286THFNA19101	✓	72	W615	449THFS9101		73	X056	048A11O901	✓	168
U990A	184TTGN6544		79	W551	256THFNA9001	✓	72	W616	445THFN9005		74	X057	048A11O900	✓	168
U991	SEE U991A		80	W553	256THFNA9026	✓	72	W617	445THFN9028		74	X058	048A17O2001	✓	168
U991A	213TTGN6540	✓	80	W553-P	256THFNA19056	✓	72	W618	445THFN9038		74	X059	048A17O2002	✓	168
U991A-P	213TTGN16548	✓	80	W554	256THFNA19033	✓	72	W618-P	445THFN19070	✓	74	X060	048A17O2003	✓	168
U992	SEE U992A		80	W555	286THFNA9076	✓	72	W619	449THFS9030		74	X061	048A11O2022	✓	168
U992A	215TTGN6539	✓	80	W556	286THFNA19077		72	W621	449THFS19092		74	X062	048A11O2009	✓	168
U992A-P	215TTGN16539	✓	80	W558	284THFNA9001	✓	72	W622	449THFS9088		74	X063	048A11O2028	✓	168
U1248	182TTDW6001	✓	43	W559	284THFNA9005		72	W624	449THFS9003		74	X064	048A11O2011	✓	168
U1266	182TTDW6076	✓	42	W560	284THFNA9026	✓	72	W626	449THFS9028		74	X065	048A11O2012	✓	168
U1267	184TTDW6076	✓	42	W560-P	284THFNA19048	✓	72	W626-P	449THFS19342	✓	74	X066	048A11O2013	✓	168
U1402	SEE U402C		41	W561	284THFNA19033	✓	72	W630	449THFS19079		74	X067	048A11O2014	✓	168
U1404	SEE U404B		41	W562	324THFS9076	✓	72	W632	449THFS9027		74	X068	048A11O2015	✓	168
U1425	182TTDW4074	✓	38	W563	324THFS9080		72	W634	449THFS9001		74	X069	048A17O2004	✓	168
U1426	SEE U426B		38	W565	286THFNA9001	✓	72	W635	449THFS9036		74	X070	048A11O2024	✓	168
U1608	182TTFW4040	✓	48	W567	286THFNA9026	✓	72	W636	444THFN19081		73	X071	048A11O2026	✓	168
U1619	184TTFW4040		48	W567-P	286THFNA19066	✓	72	W638	145THTN19079		71	X072	048A11T646	✓	179
U1647	SEE U647B		58	W568	286THFNA19033		72	W639	364THFS19077		73	X073	048A11O11064	✓	180
U1652	SEE U652B		58	W569	326THFS9076	✓	72	W640	365THFS19077		73	X074	048A11O11042	✓	180
U1779	364TTDCA6060	✓	44	W571	324THFS9001	✓	73	W641	445THFN19033		73	X075	048A11O11063	✓	180
U1782	SEE GT0042		46	W573	324THFS9026	✓	73	W642	445THFN19034	✓	74	X076	048A11T11006	✓	179
U1783	SEE GT0043		46	W573-P	324THFS19058	✓	73	W643	326THFS19078		72	X077	048A11O11066	✓	180
U1784	SEE GT0045		46	W574	324THFS19033		73	X000	048A11O1798	✓	166	X080	SEE X081	✓	160
U1927	364TTDCA6086	✓	44	W575	SEE W575A		73	X001	048A11O1799	✓	166	X081	048A11O2031	✓	160
U1928	SEE GT0038		46	W575A	364THFS19087	✓	73	X002	048A11O1769	✓	166	X082	SEE X083	✓	160
W501	143THTN9026	✓	71	W576	365THFS19101		73	X003	048A11O2042	✓	166	X083	048A11O2034	✓	160
W502	143THTN19033		71	W577	326THFS9001		73	X004	048A11O1755	✓	166	X085	048A11O678	✓	161
W503	145THTN9076		71	W578	326THFS9005		73	X005	048A11O1756	✓	166	X086	048A8O2001	✓	161
W504	182THFS19101		71	W579	326THFS9036		73	X006	048A11O2001	✓	166	X087	048A11O2029	✓	160
W505	143THTN9001		71	W580	326THFS9026	✓	73	X009	048A11O787	✓	166	X088	048A11O2032	✓	161
W506	143THTN9005		71	W580-P	326THFS19071	✓	73	X010	048A11O2046	✓	166	X089	048A11O2035	✓	161
W507	145THTN9026	✓	71	W581	326THFS19033		73	X011	048A17O2005	✓	160,166	X090	048A11O2007	✓	161
W508	145THTN19045		71	W582	SEE W582A		73	X012	048A17O2006	✓	160,166	X096	048A11O840	✓	161

Index

Catalog Number/Model Number

CAT. NO.	MODEL NO.	STOCK	PAGE NO.	CAT. NO.	MODEL NO.	STOCK	PAGE NO.	CAT. NO.	MODEL NO.	STOCK	PAGE NO.	CAT. NO.	MODEL NO.	STOCK	PAGE NO.
X097	048A80182	✓	160	X432	056A11O29	✓	162	X905	SEE C1314		102	Y369	145THFR5330	✓	84
X098	048A80181	✓	161	X433	056A11O30	✓	162	X906	SEE C1315		102	Y370	182THFR5329	✓	85
X099	048A11O2016	✓	161	X440	048A11O2065	✓	161	X908	SEE C1909		102	Y371	182THFR5330		85
X200	048A11O1060	✓	185	X441	048A11O2062	✓	161	X909	048S17T2004	✓	104	Y372	SEE Y1372		85
X203	048A11O1062	✓	181	X442	048A11O2064	✓	161	X910	048S17T366	✓	104	Y373	SEE Y373A		85
X206	056A11O5310	✓	163	X443	048A11O2063	✓	161	X911	048S17T365	✓	104	Y373A	184THFW7736	✓	85
X207	056A11O5311	✓	163	X444	048A11O1596	✓	161	X912	056B17T5303	✓	101	Y374	056H17T2018	✓	84
X208	056A8O5	✓	161	X445	048A11O1732		163	X913	056B17T20	✓	101	Y375	056H17T2020		84
X209	048A8O183	✓	166,184	X446	048A11O1643	✓	163	X920	048A17T2005	✓	186	Y376	056H17F2018	✓	84
X210	048A11O1068	✓	181	X447	048A11O1642	✓	163	X921	048A17T2006	✓	186	Y377	056H17F2016		84
X211	048A17O125	✓	166,182	X448	056A11O5314	✓	163	X922	048A17T2007	✓	186	Y378	056H17F2022	✓	84
X212	048A11O1065		185	X449	056A11O5315		163	X923	048A11T2024	✓	186	Y379	056H17F2020	✓	84
X213	048A11O1524	✓	160	X450	048A8T71	✓	162	X924	048A11T2025	✓	186	Y380	184TTF57290		188
X214	048A11O1525	✓	161	X451	048A8T72	✓	162	X925	048A11T2026	✓	186	Y381	213TTF57238		188
X215	048A11O1081		185	X452	048A8T73	✓	162	X1903	5KH32FNA499S	✓	102	Y382	215TTF57290	✓	188
X216	048A11O1097	✓	161,184	X453	048A11O1771	✓	161	X1904	5KH33JNA500S	✓	102	Y383	254TTFNA7210		188
X218	056A11O5313	✓	185	X454	048A17O250	✓	161	Y201	215TTDW7376		192	Y384	256TTFNA7250	✓	188
X219	048A11O2047	✓	166	X455	048A11O1770	✓	161	Y202	215TTDW7377	✓	192	Y385	284TTFNA7240	✓	188
X221	048A11O1526	✓	161	X456	048A11T578	✓	162	Y203	254TTDX7377		192	Y386	286TTFNA7260	✓	188
X222	048A11O1109	✓	181	X457	048A11T579	✓	162	Y204	256TTDX7391	✓	192	Y387	324TTF57290	✓	188
X223	048A11O2050	✓	181	X458	048A11T580	✓	162	Y209	365TTDS7383		192	Y388	326TTF59210	✓	188
X230	048A17O136	✓	177,182	X459	048A11T581	✓	162	Y210	404TTDS7387		192	Y389	364TTF59234	✓	188
X235	056T11D5209	✓	182	X462	048A11T619	✓	162	Y211	405TTDS7697		192	Y390	365TTF59230	✓	188
X236	048A11O699	✓	166,181,184	X463	048A17T356	✓	162	Y212	444TTDS8699	✓	192	Y391	405TTF57297		188
X237	048A11O694		166,181	X464	048A17T359	✓	162	Y213	445TTDS9477		192	Y392	444TTF57262		188
X241	048A11O697	✓	166,181	X465	048A8T11002	✓	162	Y215	284TTDP7692	✓	192	Y393	286THNA7026	✓	87
X242	048A11O756	✓	166,181	X466	048A17T86	✓	162	Y216	286TTDP7689	✓	192	Y394	286THNA7036		87
X251	056T34D5364	✓	173,182	X467	048A17T87	✓	162	Y217	324TTDP7687	✓	192	Y395	284THFA8086		88
X258	048A11O1167	✓	168	X468	048A17T96	✓	162	Y218	326TTDP7697	✓	192	Y409	SEE Y409A		189
X259	056T11O15	✓	183	X469	048A11T276	✓	162	Y219	505UTDS1584		192	Y409A	182TTDW7211	✓	189
X260	048A11O2051	✓	182	X470	048A11O885	✓	184	Y220	505UTDS1590		192	Y412	SEE Y412A		189
X261	048A8O151	✓	182	X471	048A11O1044	✓	167	Y250	---		83	Y412A	184TTDW7215	✓	189
X262	048A11D245	✓	177	X472	048A11O1045	✓	167	Y251	---		83	Y415	215TTDW7203	✓	189
X263	048A11O11041		177	X473	048A11O1046	✓	167	Y252	---		83	Y418	254TTDX7208	✓	189
X264	048A11O11040		177	X474	048A11O1047	✓	167	Y253	---		83	Y449	145TTDR5703	✓	189
X268	048A11O1239	✓	177,186	X475	048A17O123	✓	167	Y254	---		83	Y450	145TTDR5704		189
X269	048A17O147	✓	177,183	X476	048A17O124	✓	167	Y255	---		83	Y451	145TTDR5705	✓	189
X270	048A17O149	✓	177,185	X477	048A17O128	✓	167	Y256	---		83	Y452	145TTDR5706	✓	189
X271	056A11O5305	✓	163	X500	056T11O5300	✓	165	Y257	---		83	Y453	SEE Y1453		189
X273	048A17O161	✓	181	X501	056T11O5301	✓	165	Y258	---		83	Y454	SEE Y454A		189
X278	048A8O206	✓	161,184	X502	056T11O5302	✓	165	Y259	---		83	Y454A	184TTDW7286	✓	189
X295	048A11O1410		186	X503	056T11O5303	✓	165	Y260	---		83	Y455	215TTDW7204	✓	189
X297	048A11T509	✓	161,184	X506	056T8O5301		165	Y261	---		83	Y456	254TTDX7278	✓	189
X298	048A11O2059	✓	161	X507	056T8O5302	✓	165,177	Y262	---		83	Y457	256TTDX7263		189
X301	048A17T772	✓	178	X509	056T11O5304	✓	165	Y263	---		83	Y458	256TTDX7264	✓	189
X302	048A11T199	✓	178	X511	056T8O5303	✓	165	Y270	SEE Y270A		85	Y459	284TTDP7221	✓	189
X303	048A11T198	✓	178	X512	056T11O15511		164	Y270A	182THFW7730		85	Y460	286TTDP7217	✓	189
X304	048A11T201	✓	178	X513	056T11O5305	✓	164	Y280	056H17T15526	✓	85	Y465	145TTDR5701	✓	189
X305	048A17T2001	✓	178	X522	056T11O5308	✓	165	Y281	056H17T15528	✓	85	Y466	145TTDR5702	✓	189
X400	048A11O2017	✓	161	X523	056T11O5306	✓	164,177	Y282	056H17T15527	✓	85	Y467	SEE Y467A		189
X405	048A11O1744	✓	181	X524	056T11O5307	✓	165	Y283	143THTR15535	✓	85	Y467A	182TTDW7411	✓	189
X411	048A11T2008	✓	184	X525	056T11O5310	✓	164,177	Y284	145THTR15540	✓	85	Y468	SEE Y468A		189
X412	048A11T569	✓	162	X526	056T11O5309	✓	165	Y285	145HTN17034	✓	85	Y468A	184TTDW7230	✓	189
X413	048A11T529	✓	162	X527	056T8O5304	✓	165	Y286	182HTL17041	✓	85	Y469	215TTDW7205	✓	189
X414	048A11T571	✓	162	X528	056T8O5306	✓	164,177	Y286A	182HTY17041	✓	85	Y470	254TTDX7201		189
X415	048A11T2012	✓	162	X529	056T8O5311	✓	164,177	Y287	184HTL17038	✓	85	Y471	256TTDX7253		189
X416	048A11T2013	✓	162	X530	056T8O5307	✓	165	Y287A	184HTY17038	✓	85	Y472	284TTDP7205		189
X417	048A11O2051	✓	166	X531	056T8O15504	✓	164,177	Y302	SEE Y302A		103	Y473	286TTDP7251		189
X418	048A11O2052	✓	166	X532	056T11O11001	✓	164	Y302A	184TTDW7611	✓	103	Y485A	182TTDW7203		189
X419	048A11O2053		166	X533	056T11O11002	✓	164	Y303	SEE Y1303		103	Y486	SEE Y486A		189
X420	048A17O169	✓	160	X600	048C17D2057		183	Y304	215TTDW7301	✓	103	Y486A	184TTDW7287	✓	189
X422	048A17O172	✓	161	X601	056C17D2101	✓	183	Y360	056H17T2017	✓	84	Y488	213TTDW7202		189
X423	048A11O2055	✓	160	X602	056C17D2102	✓	183	Y361	056H17T2019		84	Y489	213TTDW7201	✓	189
X424	048A11O2054	✓	161	X603	056C17D5346	✓	183	Y362	056H17F2017	✓	84	Y490	215TTDW17206		189
X426	048A11O1375	✓	161,177	X700	SEE 4722		178,185	Y363	056H17F2015		84	Y491	215TTDW7201		189
X427	048A11T2017		162	X701	SEE 4404		178,185	Y364	056H17F2021	✓	84	Y492	256TTDX7207		189
X428	SEE X412		162	X900	SEE H247		102	Y365	056H17F2019	✓	84	Y493	284TTDP7202		189
X429	048A11T2020	✓	162	X902	056B17F5324		101	Y366	145THTR5329	✓	84	Y500	056H17T2011	✓	84
X430	048A11T463	✓	162	X903	SEE X1903		102	Y367	145THTR5330		84	Y501	056H17T2012	✓	84
X431	048A11O1461	✓	164	X904	SEE X1904		102	Y368	145THFR5329	✓	84	Y502	056H17T2013	✓	84

Catalog Number/Model Number

CAT. NO.	MODEL NO.	STOCK	PAGE NO.	CAT. NO.	MODEL NO.	STOCK	PAGE NO.	CAT. NO.	MODEL NO.	STOCK	PAGE NO.	CAT. NO.	MODEL NO.	STOCK	PAGE NO.
Y503	056H17T2014	✓	84	Y575	405THFS8036	✓	89	Y917	---	---	83	Y1602	---	---	146
Y504	056H17T2015	✓	84	Y576	444THFN8036	✓	89	Y918	---	---	83	Y1603	---	---	146
Y505	056H17T2016	---	84	Y577	445THFN8036	✓	89	Y920	---	---	83	Y1604	---	---	146
Y506	056H17F2011	✓	84	Y578	445THFN8040	✓	89	Y921	---	---	83	Y1605	---	---	146
Y507	056H17F2012	---	84	Y579	449THFS8036	✓	89	Y922	---	---	83	Y1606	---	---	146
Y508	056H17F2013	---	84	Y580	449THFS8037	✓	89	Y923	---	---	83	Y1607	---	---	146
Y509	254THTNA8058	✓	88	Y582	286THFPA8086	---	88	Y924	---	---	83	Y1608	254TTFPA14014	---	146
Y510	256THTNA8038	✓	88	Y583	324THFPA8086	---	88	Y925	---	---	83	Y1609	254TTFNA14336	---	146
Y511	284THFPA8038	✓	88	Y584	326THFPA8086	---	88	Y926	---	---	83	Y1610	256TTFNA14022	---	146
Y512	286THFPA8038	✓	88	Y585	364THFS8391	---	88	Y927	---	---	83	Y1611	256TTFNA14071	---	146
Y513	324THFPA8038	✓	88	Y586	365THFS8380	---	88	Y928	---	---	83	Y1612	284TSTFPA14007	---	146
Y514	326THFPA8038	✓	88	Y587	404THFS8092	---	88	Y929	---	---	83	Y1613	284TTFPA14055	---	146
Y515	364THFS8046	✓	88	Y588	405THFS8378	✓	88	Y930	---	---	83	Y1614	286TSTFPA14006	---	146
Y516	365THFS8046	✓	88	Y589	444THFN8384	✓	89	Y931	---	---	83	Y1615	286TTFNA14050	---	146
Y517	405THFS8046	✓	89	Y590	145THTN8037	✓	88	Y932	---	---	83	Y1616	324TSTFPA14010	---	146
Y518	444THFN8046	✓	89	Y592	056H17T2001	✓	86	Y933	---	---	83	Y1618	324TTFPA14071	---	146
Y519	445THFN8046	✓	89	Y595	213THFS8028	✓	88	Y934	---	---	83	Y1619	326TSTFPA14013	---	146
Y520	445THFN8050	✓	89	Y596	215THFS8029	✓	88	Y935	---	---	83	Y1621	326TTFNA14046	---	146
Y521	056H17F2014	---	84	Y597	254THFNA8038	✓	88	Y936	---	---	83	Y1622	364TSTFS14009	---	146
Y522	145THTR5328	✓	84	Y598	256THFNA8038	✓	88	Y937	---	---	83	Y1624	364TTFNA14064	---	146
Y523	145THFR5326	---	84	Y600	056H17E5301	✓	87	Y938	---	---	83	Y1625	365TSTFS14009	---	146
Y525	143THTN8028	✓	88	Y601	056H17E5302	✓	87	Y939	---	---	83	Y1627	365TTFNA14071	---	146
Y526	145THTN8029	✓	88	Y602	056H17E5303	✓	87	Y940	---	---	83	Y1628	405TSTFS14007	---	146
Y527	182HTS8028	✓	88	Y603	056H17E5304	✓	87	Y941	---	---	83	Y1630	405TTFNA14328	---	146
Y530	SEE Y370	---	85	Y604	056H17E5305	✓	87	Y942	---	---	83	Y1631	---	---	147
Y531	449THFS8046	✓	89	Y605	056H17T2021	✓	84	Y943	---	---	83	Y1632	---	---	147
Y532	449THFS8047	✓	89	Y606	056H17T2022	✓	84	Y944	---	---	83	Y1633	---	---	147
Y533	449THFS8048	✓	89	Y611	145THTR16031	✓	86	Y945	---	---	83	Y1634	445TSTFN14013	---	147
Y534	056H17T5301	✓	86	Y612	145THTR16032	✓	86	Y946	---	---	83	Y1635	445TTFNA14067	---	147
Y535	056H17T5302	✓	86	Y621	SEE U501	---	144	Y947	---	---	83	Y1636	445TTFNA14337	---	147
Y536	143THTR5326	✓	86	Y623	SEE U503	---	144	Y948	---	---	83	Y1637	445TSTFN14014	---	147
Y537	145THTR5376	✓	86	Y624	SEE U504	---	144	Y949	---	---	83	Y1638	445TSTFN14066	---	147
Y538	145THTR5326	✓	86	Y625	SEE U505	---	144	Y950	---	---	83	Y1639	445TTFNA14338	---	147
Y540	184THTL7776	✓	86	Y627	SEE U507	---	144	Y951	---	---	83	Y1640	449TSTFS14012	---	147
Y541	182HTL7726	✓	86	Y629	SEE U509	---	144	Y952	---	---	83	Y1641	449TSTFS14040	---	147
Y541A	182HTY7726	✓	86	Y631	SEE U511	---	144	Y953	---	---	83	Y1642	449TTFNA14055	---	147
Y542	213HTL7776	✓	86	Y633	SEE U513	---	144	Y954	---	---	83	Y1643	---	---	147
Y543	184HTL7726	✓	86	Y635	SEE U515	---	144	Y955	---	---	83	Y1644	449TSTFS14045	---	147
Y543A	184HTY7726	✓	86	Y637	SEE U517	---	144	Y956	---	---	83	Y1645	449TTFNA14057	---	147
Y544	215HTL7776	✓	86	Y639	SEE U519	---	144	Y957	---	---	83	Y1646	---	---	147
Y545	213HTL7726	✓	86	Y641	SEE U538	---	144	Y958	---	---	83	Y1647	449TSTFS14044	---	147
Y546	254HTL5776	✓	86	Y643	SEE U523	---	144	Y978	143THEN8034	✓	89	Y1648	449TTFNA14056	---	147
Y547	215HTL7726	✓	86	Y645	SEE U525	---	145	Y979	145THEN8034	✓	89	Y1649	---	---	147
Y548	256HTL5776	✓	86	Y647	SEE U527	---	145	Y980	182THES8048	✓	89	Y1650	---	---	147
Y549	254HTL5726	✓	86	Y649	SEE U529	---	145	Y981	213THES8053	✓	89	Y1651	---	---	147
Y551	145HTN6046	✓	86	Y651	SEE U531	---	145	Y982	254THEN8058	✓	89	Y1652	---	---	147
Y552	256HTNA7026	✓	87	Y658	SEE U539	---	145	Y983	254THEN8059	✓	89	Y1999	182THFW7729	✓	85
Y553	284HTNA7026	✓	87	Y659	SEE U540	---	145	Y984	256THEN17031	✓	89	Z112	SEE Z112A	---	100
Y555	056H17T5311	✓	86	Y663	SEE U521	---	144	Y985	284THEN8032	✓	89	Z112A	182TCFW9061	✓	100
Y556	056H17T5312	✓	86	Y822A	405TTFNA14554	✓	187	Y986	143HTN8036	✓	90	Z113	SEE Z113A	---	100
Y557	145HTN6060	✓	86	Y824	444TTF88841	✓	187	Y987	145HTN8043	✓	90	Z113A	184TCFW9057	✓	100
Y558	182HTL7736	✓	86	Y826A	445TTFNA14571	✓	187	Y988	182HTS8048	✓	90	Z114	SEE Z114A	---	100
Y558A	182HTY7736	✓	86	Y855A	449TTFNA14584	✓	187	Y989	184HTS8056	✓	90	Z114A	184TBFW7070	✓	100
Y559	184HTL7736	✓	86	Y857	449TTF88581	---	187	Y990	213HTS8071	✓	90	Z115	215TBFW7028	✓	100
Y559A	184HTY7736	✓	86	Y900	---	---	83	Y991	215HTS8071	✓	90	Z116	215TBFW7044	✓	100
Y559	184HTL7736	✓	86	Y901	---	---	83	Y992	254HTNA8071	✓	90	Z117	213TBFW7027	✓	100
Y560	213HTL7736	✓	86	Y902	---	---	83	Y993	256HTNA8071	✓	90	Z118	145TFR5328	✓	99
Y561	215HTL7736	✓	86	Y903	---	---	83	Y994	213THFW7726	✓	85	Z119	SEE Z119A	---	99
Y562	254HTL5736	✓	86	Y904	---	---	83	Y995	213THFW7736	---	85	Z119A	182TCFW7072	✓	99
Y563	256HTNA7036	✓	87	Y905	---	---	83	Y996	215THFW7726	✓	85	Z120	SEE Z120A	---	99
Y564	184HTS8028	✓	88	Y906	---	---	83	Y997	215THFW7736	---	85	Z120A	184TBFW17045	✓	99
Y565	213HTS8038	✓	88	Y907	---	---	83	Y998A	SEE Y1999	---	85	Z121	SEE Z121A	---	99
Y566	215HTS8038	✓	88	Y908	---	---	83	Y999	SEE Y1999	---	85	Z121A	184TBFW7737	✓	99
Y567	284HTNA7036	---	87	Y910	---	---	83	Y1303	184TDDW7612	✓	103	Z122	215TBFW7029	✓	99
Y569	284THFPA8028	✓	88	Y911	---	---	83	Y1372	184THFW7726	✓	85	Z123	143TCFR5328	✓	99
Y570	286THFNA8028	✓	88	Y912	---	---	83	Y1453	182TDDW7413	✓	189	Z124	SEE Z124A	---	160
Y571	324THFPA8028	✓	88	Y913	---	---	83	Y1484	182TDDW7412	✓	189	Z124A	184TBDW7369	---	160
Y572	326THFS8028	✓	88	Y914	---	---	83	Y1487	184TDDW7209	✓	189	Z125	215TBDW7361	---	160
Y573	364THFS8036	✓	88	Y915	---	---	83	Y1600	---	---	146	Z126	215TBDW7362	---	160
Y574	365THFS8036	✓	88	Y916	---	---	83	Y1601	---	---	146	Z127	256TBDX7028	---	160

Index

Catalog Number/Model Number

CAT. NO.	MODEL NO.	STOCK	PAGE NO.	CAT. NO.	MODEL NO.	STOCK	PAGE NO.	CAT. NO.	MODEL NO.	STOCK	PAGE NO.	CAT. NO.	MODEL NO.	STOCK	PAGE NO.
Z128	145TFR5341	✓	99	Z641	056E17W2003		93								
Z304	145TBDR5309	✓	103	Z660	056E17T2001	✓	93								
Z305	SEE Z305A		103	Z662	056E17T2002	✓	93								
Z305A	184TCDW7615	✓	103	Z663	056E17T2003	✓	93								
Z306	SEE Z306A		103	Z664	056E17T2004	✓	93								
Z306A	184TCDW7617	✓	103	Z665	056E17T2005		93								
Z307	SEE Z307A		103	Z666	056E17F2008	✓	93								
Z307A	184TBDW7009	✓	103	Z667	056E17F2009	✓	93								
Z308	215TCDW7003	✓	103	Z668	056E17F2010	✓	93								
Z309	182TCDR7013		103	Z669	056E17F2011	✓	93								
Z313	184TBDR7324		103	Z670	056E17F2014	✓	93								
Z314	215TCDW7012		103	Z671	056E17F2015	✓	93								
Z315	215TBDW7013		103												
Z401	143TCDR5328		124												
Z403	145TCDR5328		124												
Z404	145TBDR5304		124												
Z405	SEE Z405A		124												
Z405A	182TCDW7074	✓	124												
Z406	SEE Z406A		124												
Z406A	182TCDW7318	✓	124												
Z407	SEE Z407A		124												
Z407A	184TCDW7047	✓	124												
Z408	SEE Z408A		124												
Z408A	184TBDW17007	✓	124												
Z409	213TCDW7027	✓	124												
Z410	213TCDW7002	✓	124												
Z411	215TBDW7029	✓	124												
Z412	215TCDW7002	✓	124												
Z413	215TBDW7027	✓	124												
Z420	143TCDR5330		132												
Z422	145TCDR5329		132												
Z424	182TCDR7354		132												
Z425	182TCDR8005		132												
Z426	184TCDR7626		132												
Z427	SEE Z427A		132												
Z427A	184TBDW17011	✓	132												
Z428	213TCDW7028		132												
Z429	213TCDW7003	✓	132												
Z430	215TBDW7045		132												
Z431	215TCDW7004	✓	132												
Z432	215TBDW7030		132												
Z433	SEE Z433A		124												
Z433A	184TBPW7315	✓	124												
Z434	213TBPW7010	✓	124												
Z435	215TBPW7010	✓	124												
Z502	184TBDR5326	✓	188												
Z504	184TBDR5301		188												
Z506A	184TBDW7656		188												
Z602	056E17F1001	✓	92												
Z603	056E17F1002	✓	92												
Z604	056E17F1003	✓	92												
Z605	056E17F1004	✓	92												
Z606	056E17F1005	✓	92												
Z607	056E17F1006	✓	92												
Z610	056E17F1007	✓	92												
Z611	056E17F1008	✓	92												
Z612	056E17F2005	✓	92												
Z613	056E17F2006	✓	92												
Z614	056E17F2007	✓	92												
Z615	145TEFR5326	✓	92												
Z616	145TEFR5327	✓	92												
Z617	182TEFR5326	✓	92												
Z630	056E17V2001	✓	93												
Z631	056E17V2002		93												
Z634	056E17V2003	✓	93												
Z635	056E17V2004	✓	93												
Z636	056E17V2005	✓	93												
Z637	056E17V2006		93												
Z638	056E17W2001	✓	93												
Z639	056E17W2002	✓	93												

Model Number/Catalog Number

MODEL NO.	CAT. NO.	STOCK	PAGE NO.	MODEL NO.	CAT. NO.	STOCK	PAGE NO.	MODEL NO.	CAT. NO.	STOCK	PAGE NO.	MODEL NO.	CAT. NO.	STOCK	PAGE NO.
003062.09	A960A	✓	219	5K46KN2175	K166	✓	48	5K49PN3052	K280	✓	173	5KC35MN145	C1405	✓	32
5K32GN30	K151	✓	47	5K46KN4031	K1308	✓	41	5K49PN3053	K279	✓	173	5KC35MN43	G1330	✓	29
5K32GN48	K281	✓	172	5K46KN4071	K119	✓	36	5K49PN4088X	K1415	✓	173	5KC35MN43X	G1331	✓	29
5K32GN53	K418	✓	47	5K46KN4085	K277	✓	173	5K49PN4113	K198	✓	47	5KC35MN73	G1513	✓	31
5K32GNB249X	K717	✓	76	5K46KN4085X	K1410	✓	173	5K49PN4120	K521	✓	40	5KC36GN2507X	C1168	✓	120
5K33FN30	K153	✓	47	5K46KN4125	K250	✓	40	5K49PN4121	K751	✓	122	5KC36JN266	G1098	✓	21
5K33GN45	K275	✓	173	5K46KN4141	K555	✓	122	5K49PN4564	K458	✓	97	5KC36JN268X	C330	✓	121,176
5K33JNA943	K253	✓	51	5K46LN6033S	K378	✓	165	5K49PN4565	K460	✓	97	5KC36JN269X	C331	✓	121
5K33KN52	K283	✓	172	5K46LN6428S	K1505	✓	165	5K49PN6019	K1300	✓	40	5KC35JN8X	C145	✓	21
5K33KN67	K522	✓	51	5K46MN4072	K122	✓	36	5K49PN6025	K1317	✓	51	5KC36LN1	C215	✓	24
5K33KN92	K194	✓	47	5K46MN4087	K278	✓	173	5K49PN6164	K1490	✓	51	5KC36LN144	C1420	✓	32
5K35FN101	K748	✓	122	5K46MN4087X	K1412	✓	173	5K49PN8030	K1318	✓	51	5KC36LN144X	C444	✓	32
5K35FN2	K113	✓	36	5K46MN4126	K251	✓	40	5K49QN4609	K640	✓	52	5KC36LN166X	C349	✓	31
5K35FN55	KG215	✓	40,122,176	5K46MN4144	K750	✓	122	5K49RN4570	K1494	✓	97	5KC36LN18	C431	✓	21
5K35JN198	K527	✓	36	5K46MN4623	K635	✓	41	5K49RN4617	K646	✓	41	5KC36LN19X	C460	✓	24
5K35JN47	K230	✓	123	5K46MN6018	K1299	✓	40	5K49RN4621X	K610	✓	65	5KC36LN19X	C216	✓	24,171
5K35MN294	K282	✓	172	5K46PN6082	K162	✓	47	5K49RN6034S	K379	✓	165	5KC36LN26	C209	✓	24
5K35MN75	K321	✓	47	5K48TN2181	K227	✓	122	5K49RN6118S	K1485	✓	164	5KC36LN26X	C210	✓	24
5K35MNB114	K254	✓	51	5K48TN2182	K226	✓	40,122,176	5K49RN6429S	K1510	✓	165	5KC36LN30	C153	✓	21
5K35MNB117	K158	✓	47	5K48TN6119S	K1486	✓	164,177	5K49RN8424	K622	✓	40	5KC36LN30X	C154	✓	21
5K36JN2	K115	✓	36	5K48TN6430S	K1515	✓	165	5K49SN2184	K238	✓	123	5KC36LN4003Y	C664	✓	99
5K36JN56	K217	✓	122	5K48UN3056	K520	✓	173	5K49SN2187	KG237	✓	51	5KC36LN7	C158	✓	21
5K36JN57	K216	✓	40,122,176	5K48UN3057	K549	✓	173	5K49SN3054	K518	✓	173	5KC36LN7X	C159	✓	21
5K36MNB39	KG232	✓	123	5K48WN3013S	K1482	✓	165,177	5K49SN3055	K519	✓	173	5KC36LN83X	C356	✓	27
5K36MN4152	K633	✓	51	5K48WN3181S	K1511	✓	165,177	5K49SN4117	K257	✓	51	5KC36LN84X	C683	✓	121
5K36PN251	G1340	✓	47	5K49DN4130	K252	✓	51	5K49SN4118	K167	✓	48	5KC36MN20	CG393	✓	23
5K36PN254	K523	✓	51	5K49DN4131	K439	✓	47	5K49SN4119	K260	✓	54	5KC36MN2508X	C1169	✓	120
5K36PN30	K155	✓	47	5K49DN4132	K247	✓	40	5K49SN8050	K408	✓	37	5KC36MN27X	C133	✓	26
5K36PN345S	K1403	✓	165	5K49FN2045	K1306	✓	41	5K49TN4622X	K609	✓	65	5KC36PNB169X	C646	✓	34
5K36PNB111	K161	✓	47	5K49FN4129	K196	✓	47	5K49TN6383X	K2110	✓	76	5KC37EN3900U	4788	✓	175
5K36PNB116	K255	✓	51	5K49FN4136	K154	✓	47	5K49UN4086X	K1418	✓	173	5KC37FN65X	C329	✓	121
5K37MN252X	K1409	✓	173	5K49FN4138	K248	✓	40	5K49UN4566	K461	✓	97	5KC37FN71X	J1025	✓	121,176
5K37MN3543	K1483	✓	122	5K49FN6381X	K2101	✓	76	5K49UN4567	K462	✓	97	5KC37HN3898U	4781	✓	175
5K37MN37	K218	✓	40,122,176	5K49HN6385X	K2104	✓	76	5K49UN4569	K459	✓	97	5KC37LN502Y	C1474	✓	21
5K37MN38	KG219	✓	122	5K49JN4051T	K1476	✓	104	5K49UN6085	K165	✓	47	5KC37LN91	CG111	✓	23
5K37NN30	K160	✓	47	5K49JN4574X	K2105	✓	76	5K49UN8052	KG319	✓	195	5KC37MN96	C459	✓	21
5K38PN258X	K1411	✓	173	5K49JN4582X	K2102	✓	76	5K49WN4335X	K1497	✓	173	5KC37NN115X	C847	✓	121
5K38PN47	K220	✓	40,122,176	5K49KN2150X	K1413	✓	173	5K49ZN2190	K240	✓	123	5KC37NN14T	C457	✓	24
5K38PN48	K221	✓	122	5K49KN4124	K258	✓	53	5K49ZN4252	K1492	✓	48	5KC37NN15	C164	✓	21
5K38RN106	K500	✓	53	5K49KN4142	K286	✓	172	5K49ZN4253	K1491	✓	51	5KC37NN160	C449	✓	23
5K38RN30	K163	✓	47	5K49KN4563	K457	✓	97	5K49ZN4611	K644	✓	40	5KC37NN3544T	C1467	✓	159
5K38RN49	KG234	✓	123	5K49KN4573	K456	✓	97	5K49ZN4616	K648	✓	41	5KC37NN501Y	C1475	✓	21
5K38SN267S	K1404	✓	165	5K49MN4104	K256	✓	51	5K49ZN6433S	K1520	✓	165	5KC37RN35	CG260	✓	29
5K39SNB505S	K1402	✓	165	5K49MN4105	K164	✓	47	5KC32GN13	C247	✓	172	5KC38NN410X	C1155	✓	24,171
5K39SNB587S	K1407	✓	165	5K49MN4110	K259	✓	53	5KC32GN19	G1312	✓	29	5KC38NN413X	C1154	✓	24,171
5K39SNB765T	K1405	✓	165	5K49MN4111	K424	✓	47	5KC32GN19X	CG251	✓	29	5KC38PN2509X	C1170	✓	120
5K42FN4033	K1305	✓	41	5K49MN4112	K524	✓	51	5KC32GN25	G1511	✓	31	5KC38RN4153Y	C702	✓	21
5K42FN4035	K1322	✓	53	5K49MN4114	K525	✓	172	5KC32GN9	C242	✓	29	5KC38RN60	C179	✓	21
5K42GN4619X	K606	✓	65	5K49MN4618X	K608	✓	65	5KC32GN9X	C243	✓	29	5KC38RN60X	C180	✓	21
5K42HN4032	K1307	✓	41	5K49MN4620X	K607	✓	65	5KC33FN31	C1419	✓	31	5KC38SN2510X	C1171	✓	120
5K42HN4034	K1324	✓	53	5K49MN6020	K1316	✓	51	5KC33FN4180X	C1336	✓	121	5KC39EN2500X	C1087	✓	120
5K42HN4089	K381	✓	173	5K49MN6079	K159	✓	47	5KC33KN19	C462	✓	29	5KC39EN2553X	C1081	✓	120
5K42HN4089X	K1408	✓	173	5K49MN6080	K285	✓	172	5KC33MN2502X	C1089	✓	120	5KC39HN2501X	C1088	✓	120
5K42HN4106	K116	✓	36	5K49MN6081	K541	✓	172	5KC33MN2555X	C1083	✓	120	5KC39HN2554X	C1082	✓	120
5K42HN4108	K197	✓	47	5K49MN6126T	K1487	✓	178	5KC33MN2889X	C1463	✓	120	5KC39HN2888X	C1462	✓	120
5K42HN4127	K249	✓	40	5K49MN6369	K526	✓	97	5KC35FN51X	C208	✓	24	5KC39NN50X	C332	✓	121,176
5K42HN4128	K284	✓	172	5K49MN6382X	K2116	✓	76	5KC35GNA488	CG382	✓	190	5KC39PN5105X	C1083A	✓	120
5K42HN4133	K550	✓	123	5K49MN6432S	K1500	✓	165	5KC35JN10	C147	✓	21	5KC39PN6200X	C1089A	✓	120
5K42HN4134	K426	✓	47	5K49MN8349X	K2107	✓	76	5KC35JN10X	C148	✓	21	5KC39PN6201X	C1463A	✓	120
5K42HN4137	K469	✓	51	5K49NN2046	K1311	✓	41	5KC35JN12	C200	✓	24	5KC39QN3218X	C465	✓	121
5K42HN4139	K553	✓	122	5K49NN2147X	K1416	✓	173	5KC35JN12X	CG201	✓	24	5KC39QN3219X	C333	✓	121
5K42JN3050	K546	✓	173	5K49NN2178	K225	✓	122	5KC35JN23X	C129	✓	26	5KC39QN3220X	C1152	✓	24,171
5K42JN3051	K544	✓	173	5K49NN2180	K224	✓	40,122,176	5KC35JN27Y	CG105	✓	23	5KC39RN114T	CG732	✓	121
5K42JN4163	K318	✓	36	5K49NN4052T	K1438	✓	104	5KC35JN7	G1114	✓	24,171	5KC39RN383X	C1157	✓	24,171
5K46HN2546	K690	✓	41	5K49NN4580X	K2111	✓	76	5KC35JN70X	C354	✓	27	5KC39RN44X	C334	✓	121,176
5K46KN2082	K1484	✓	122	5K49NN4581X	K2115	✓	77	5KC35JN7X	G1115	✓	24,171	5KC39RN45X	C335	✓	121
5K46KN2172	K223	✓	122	5K49PN2330	KG236	✓	123	5KC35JNA489	CG383	✓	190	5KC39SN2810X	C1084	✓	120
5K46KN2173	K222	✓	40,122,176	5K49PN2348	KG235	✓	51	5KC35JNA489Y	CG384	✓	190	5KC39SN2812X	C1090	✓	120

Index

Model Number/Catalog Number

MODEL NO.	CAT. NO.	STOCK	PAGE NO.	MODEL NO.	CAT. NO.	STOCK	PAGE NO.	MODEL NO.	CAT. NO.	STOCK	PAGE NO.	MODEL NO.	CAT. NO.	STOCK	PAGE NO.
5KC39SN2890X	C1464	✓	120	5KC49PN0161	C181	✓	21	5KCR39SN2557X	C1085	✓	120	5KCR49SN3009X	C1478	✓	25,171
5KC42GN0014	C261	✓	29	5KC49PN0161U	C1480	✓	21,187,193	5KCR39SN2891X	C1465	✓	120	5KCR49SN3010	C476	✓	25,171
5KC42GN0014X	C262	✓	29	5KC49PN0161X	C182	✓	21	5KCR39UN2505X	C1092	✓	120	5KCR49TN2139U	G1392	✓	30
5KC42GN0018	G1515	✓	31	5KC49PN0162	C188	✓	21	5KCR39UN2511X	C1172	✓	120	5KCR49TN2155T	C466	✓	31
5KC42GN0018X	C446	✓	31	5KC49PN0163X	CG363	✓	27	5KCR39UN2512X	C1173	✓	120	5KCR49TN2164T	C878	✓	121
5KC42GN0066	C375	✓	32	5KC49PN0164X	C1158	✓	24,171	5KCR39UN2558X	C1086	✓	120	5KCR49TN8058T	C1274	✓	159
5KC42GN0309X	C289	✓	172	5KC49PN0253	C1469	✓	190	5KCR39UN2892X	C1466	✓	120	5KCR49UN0079U	C1294	✓	100
5KC46GN0075U	C1291	✓	100	5KC49PN0281X	C806	✓	172	5KCR46JN0083X	E252	✓	28	5KCR49UN0106X	EG284	✓	32
5KC46GN0251	C1458	✓	190	5KC49PN0283	C1425	✓	32	5KCR46JN0083Y	E250	✓	28	5KCR49UN0106Y	EG282	✓	32
5KC46GN0251Y	C1459	✓	190	5KC49PN2144Y	C1477	✓	22	5KCR46JN0084	E251	✓	27	5KCR49UN0107	EG283	✓	31
5KC46GN0569Y	C661	✓	99	5KC49PN2521Y	C704	✓	22,187	5KCR46JN0085	E253	✓	21	5KCR49UN0108	E285	✓	30
5KC46JN0002X	C138	✓	24	5KC49PN3027X	C419	✓	25,171	5KCR46JN0086X	E254	✓	24	5KCR49WN0270T	C193	✓	22
5KC46JN0076U	C1292	✓	100	5KC49PN3036	C248	✓	29	5KCR46JN0087X	E257	✓	32	5KCR49WN0270T	CG381	✓	22
5KC46LN0149X	C1156	✓	24,171	5KC49PN6051	C1258	✓	24	5KCR46JN0087Y	E255	✓	32	5KCR49WN0295U	C1295	✓	100
5KC46LN0153	C175	✓	21	5KC49PN6051X	C548	✓	24	5KCR46JN0088	E256	✓	31	5KCR49WN6075	C178	✓	21
5KC46LN0153U	C177	✓	21	5KC49PN6062	C1333	✓	29	5KCR46JN0089	E258	✓	29	5KCR49WN6077	CG232	✓	24
5KC46LN0153X	C176	✓	21	5KC49PN6070	C1252	✓	21	5KCR46MN0054X	E263	✓	24	5KCR49WN6078	C1412	✓	32
5KC46LN0158	CG230	✓	24,171	5KC49QN0716X	C1807	✓	34	5KCR46MN0055X	E266	✓	32	5KCR49ZN0785S	C1909	✓	102
5KC46LN0158X	D1113	✓	24,171	5KC49QN0718X	C1816	✓	35	5KCR46MN0055Y	E264	✓	32	5KCR49ZN0785Y	9038B	✓	23,187
5KC46LN0159	CG361	✓	27	5KC49QN4559X	C1810	✓	34	5KCR46MN0090X	E261	✓	28	5KCR49ZN8061T	C1275	✓	159
5KC46LN0159X	CG362	✓	27	5KC49RN2152T	C1159	✓	25,171	5KCR46MN0090Y	E259	✓	28	5KE48WN4593	K2066	✓	107
5KC46LN0252	C1460	✓	190	5KC49RN2520Y	C703	✓	22	5KCR46MN0091	E260	✓	27	5KE48WN8364	K2056	✓	107
5KC46LN0252Y	C1461	✓	190	5KC49SN2156X	C855	✓	31	5KCR46MN0092	E262	✓	21	5KE48WN8365	K2033	✓	51
5KC46LN0254X	C1483	✓	26	5KC49SN2158	C1424	✓	31	5KCR46MN0093	E265	✓	31	5KE49PN4594	K2069	✓	36
5KC46LN0269X	4686	✓	171	5KC49SN2418U	C662	✓	99	5KCR46MN0094	E267	✓	29	5KE49PN8391	K2021	✓	41
5KC46NN0758Y	C1298	✓	21	5KC49SN2537Y	C1269	✓	28	5KCR46NN0264T	C1303	✓	102	5KE49PN8418	K2018	✓	40
5KC46PN0015	C268	✓	29	5KC49SN6375X	C1809	✓	34	5KCR48TN2142T	C340	✓	121,176	5KE49TN4592	K2068	✓	107
5KC46PN0015X	C269	✓	29	5KC49SN6380X	C1817	✓	35	5KCR48TN2174T	C341	✓	121	5KE49TN4597	K2067	✓	108
5KC46PN0032	G1517	✓	31	5KC49SN8060T	C1273	✓	159	5KCR48TN2650Y	9035	✓	23,187	5KE49QN8375T	K2038	✓	173
5KC46PN0359Y	C1489	✓	190	5KC49TN0033	C295	✓	30	5KCR48TN3084X	C1479	✓	25,171	5KE49UN8376T	K2037	✓	173
5KC48TN2169	C187	✓	22	5KC49TN0034	C275	✓	30	5KCR48TN8062	C194	✓	22	5KE49TN8378	K2055	✓	107
5KC48UN6052	C1264	✓	24	5KC49TN0034X	C276	✓	30	5KCR48UN0102Y	EG277	✓	28	5KE49TN8384T	K2030	✓	173
5KC48UN6052X	C552	✓	24	5KC49TN0035	G1519	✓	31	5KCR48UN0104	E280	✓	21	5KE49TN8401	K2022	✓	41
5KC48UN6072	C1422	✓	27	5KC49TN0063Y	F10E1	✓	99	5KCR48UN0105X	E281	✓	24	5KE49UN8407	K2023	✓	41
5KC48UN6073	C1263	✓	21	5KC49TN0067	C376	✓	32	5KCR48UN2653Y	9036	✓	22,187	5KE49UN8428	K2043	✓	40
5KC49GN0001	B1316	✓	24,171	5KC49TN0285X	C292	✓	172	5KCR48UN2654Y	9040	✓	187	5KE49WN4571	K2045	✓	97
5KC49GN0001X	CG223	✓	24	5KC49TN0568Y	C660	✓	99	5KCR48WN0273	G1376	✓	30	5KE49WN4572	K2046	✓	97
5KC49GN0009X	C359	✓	27	5KC49TN2141X	C338	✓	121,176	5KCR48WN0273X	G1377	✓	30	5KH32DN111	H208	✓	174
5KC49GN0010	C167	✓	21	5KC49TN2170X	C339	✓	121	5KCR48WN0292	C297	✓	30	5KH32DN3085	HG156	✓	169
5KC49GN0010X	C168	✓	21	5KC49UN6065	C264	✓	29	5KCR48WN0292Y	F15E1	✓	99	5KH32DN3085X	H157	✓	169
5KC49GN0010Y	C169	✓	21,187	5KC49UN6067	C1404	✓	31	5KCR48WN0294	G1531	✓	31	5KH32DN5587X	4725	✓	119
5KC49GN0022X	C1153	✓	24,171	5KC49ZN2539Y	C1270	✓	28	5KCR48WN0566Y	C659	✓	99	5KH32DN5597X	HG679	✓	119
5KC49HN0719X	C1803	✓	34	5KCP33GNA471S	P239	✓	104	5KCR48WN0756Y	C1299	✓	22,187	5KH32DN5618X	HG701	✓	169
5KC49HN2509X	C1814	✓	35	5KCP35CNA490S	PG240	✓	178	5KCR48WN6066	C271	✓	29	5KH32DNA612	H901	✓	22
5KC49LN6386X	H891	✓	34	5KCP35KNB057S	P250	✓	102	5KCR49PN0077U	C1293	✓	100	5KH32DNA612X	H902	✓	22
5KC49MN2043Y	9031	✓	21,187	5KCP35KNB650U	P254	✓	190	5KCR49PN0095X	E270	✓	28	5KH32DNA700	H912	✓	169
5KC49MN2049Y	9032	✓	21,187,193	5KCP35NNA670T	P247	✓	190	5KCR49PN0095Y	E268	✓	28	5KH32DNA700X	H913	✓	169
5KC49MN6061	G1316	✓	29	5KCP36NNB059S	P251	✓	102	5KCR49PN0096	E269	✓	27	5KH32EN124	H244	✓	31
5KC49MN6063	C1423	✓	31	5KCP36NNB670U	PG252	✓	190	5KCR49PN0097	EG271	✓	21	5KH32EN66	H116	✓	29
5KC49MN6379X	C1818	✓	35	5KCP36NNB671U	P253	✓	190	5KCR49PN0098X	EG272	✓	24	5KH32EN72X	H291	✓	172
5KC49MN6384X	C1801	✓	34	5KCP36RNA491S	P241	✓	178	5KCR49PN0099X	E275	✓	32	5KH32EN79	HG178	✓	172
5KC49NN0061T	4688	✓	171	5KCP39SNB480S	P193	✓	163	5KCR49PN0099Y	EG273	✓	32	5KH32ENA443X	H682	✓	119
5KC49NN0221X	9029	✓	23	5KCP39SNB481S	P194	✓	163	5KCR49PN0100	E274	✓	31	5KH32ENB168X	H454	✓	34
5KC49NN0222X	9030	✓	193	5KCP39SNB482S	P195	✓	163	5KCR49PN0101	EG276	✓	29	5KH32FN3083	H160	✓	169
5KC49NN0224X	C1187	✓	24	5KCP39TNB763T	P196	✓	163	5KCR49PN0492S	C1314	✓	102	5KH32FN3083X	HG161	✓	169
5KC49NN2044Y	9034	✓	23	5KCP39UNB764T	P198	✓	163	5KCR49PN3011	C420	✓	25,171	5KH32FN3120T	4680	✓	169
5KC49NN2050Y	9033	✓	21,187	5KCP39UNB767T	P197	✓	163	5KCR49PN3011X	C474	✓	25,171	5KH32FN3122	H134	✓	102
5KC49NN2081T	C1468	✓	159	5KCP49PN9812S	P245	✓	163	5KCR49PN3012X	C486	✓	25,171	5KH32FN3122S	H135	✓	102
5KC49NN2130X	C273	✓	30	5KCP49RN9611S	P243	✓	163	5KCR49QN6076	C183	✓	21	5KH32FN3123	HG120	✓	29
5KC49NN2130Y	C274	✓	30	5KCP49UN9613S	P244	✓	163	5KCR49RN2148T	C1161	✓	25,171	5KH32FN3123X	HG121	✓	29
5KC49NN2132X	C445	✓	32	5KCP49UN9612S	P184	✓	163	5KCR49SN0012X	CG239	✓	25	5KH32FN5586X	4406	✓	119
5KC49NN2133X	C351	✓	31	5KCP49UN9614S	P185	✓	163	5KCR49SN0042S	C1302	✓	102	5KH32FN5598X	HG680	✓	119
5KC49NN2135X	C352	✓	121	5KCP49UN9811S	P246	✓	163	5KCR49SN0065	C191	✓	22	5KH32FNA499S	X1903	✓	102
5KC49NN2140X	C336	✓	121,176	5KCP49UN9837S	F780	✓	104	5KCR49SN0068	C185	✓	22	5KH32FNA611	H903	✓	22
5KC49NN2167X	C337	✓	121	5KCP49UN9838S	F781	✓	101	5KCR49SN0068X	C186	✓	22	5KH32FNA611X	H904	✓	22
5KC49NN2419Y	C663	✓	99	5KCP49WN9813S	P180	✓	163	5KCR49SN0150X	C1160	✓	25,171	5KH32GN42	H195	✓	102
5KC49PN0155	C235	✓	24,171	5KCP49ZN9617T	P190	✓	161	5KCR49SN0493S	C1315	✓	102	5KH32GN42S	HG196	✓	102
5KC49PN0155X	CG236	✓	24	5KCR39SN2504X	C1091	✓	120	5KCR49SN3009	C475	✓	25,171	5KH32GN140X	HG152	✓	169

Model Number/Catalog Number

MODEL NO.	CAT. NO.	STOCK	PAGE NO.	MODEL NO.	CAT. NO.	STOCK	PAGE NO.	MODEL NO.	CAT. NO.	STOCK	PAGE NO.	MODEL NO.	CAT. NO.	STOCK	PAGE NO.
5KH32GN142	H204	✓	174	5KH36NN37	HG140	✓	102	5KH39QN9548	4322	✓	169	5KHC39QN9575T	H649	✓	102
5KH32GN68X	H243	✓	29	5KH36NN37S	HG141	✓	102	5KH39QN9548X	4389	✓	169	5KHC39QN9581T	HG648	✓	102
5KH32GNB811X	4805	✓	119	5KH36NNB166X	HG455	✓	34	5KH39QN9550X	4412	✓	169	5KHC39QN9584X	H647	✓	102
5KH32GNB812X	HG450	✓	119	5KH36PN106	H203	✓	102	5KH39QN9551X	4399	✓	169	5KS46MN4078	E34D4	✓	36
5KH32GNB813X	HG451	✓	119	5KH36PN108	HG189	✓	172	5KH39QN9631T	H131	✓	170	5KS49HN4077	E12D4	✓	36
5KH32GNB814X	HG681	✓	119	5KH36PN109	H233	✓	172	5KH39QN9632	H130	✓	170	5KS49HN4595	E286	✓	106
5KH32GNB815X	H712	✓	119	5KH36PNB171X	HG458	✓	34	5KH39QN9636T	4757	✓	170	5KS49UN4598	EG311	✓	108
5KH32HN5620T	HG711	✓	170	5KH37GNA782X	HG717	✓	178	5KH39QN9639T	4778	✓	26	048A11D245	X262	✓	177
5KH32HNA532T	4734	✓	174	5KH37NNA768	H907	✓	22	5KH39QN9642T	H133	✓	170	048A11O1044	X471	✓	167
5KH32JN3128	H164	✓	170	5KH37NNA768X	H908	✓	22	5KH39QN9681X	4380	✓	23	048A11O1045	X472	✓	167
5KH32JN3128X	H165	✓	170	5KH37PN33	H171	✓	169	5KH39QN9682	4370	✓	170	048A11O1046	X473	✓	167
5KH33FN6	H239	✓	21	5KH37PN33X	H172	✓	169	5KH39QN9683	4396	✓	169	048A11O1047	X474	✓	167
5KH33FN7	H212	✓	174	5KH37PN36	H209	✓	174	5KH39QN9684	4387	✓	26	048A11O1060	X200	✓	185
5KH33FN77X	H213	✓	174	5KH37PN36X	H210	✓	174	5KH39QN9686X	4362	✓	21	048A11O1062	X203	✓	181
5KH33FN85	HG123	✓	29	5KH37PN37	H205	✓	174	5KH39QN9687	4422	✓	26	048A11O1065	X212	✓	185
5KH33FN85X	HG124	✓	29	5KH37PN37X	H278	✓	174	5KH39QN9696X	4731	✓	174	048A11O1068	X210	✓	181
5KH33FNA230	H675	✓	25	5KH37PN39	H112	✓	169	5KH39QN9697T	4759	✓	170	048A11O1081	X215	✓	185
5KH33FNA722X	H915	✓	169	5KH37PN39X	HG113	✓	169	5KH39QN9698T	4758	✓	170	048A11O1097	X216	✓	161,184
5KH33GN5014U	4774	✓	175	5KH37PN40	H223	✓	174	5KH39QN9702T	4732	✓	174	048A11O11040	X264	✓	177
5KH33GNNA444X	H683	✓	119	5KH37PN41	H158	✓	169	5KH39QN9703T	4738	✓	174	048A11O11041	X263	✓	177
5KH33HNS725X	4702	✓	169	5KH37PN41X	H159	✓	169	5KH39QN9704T	4739	✓	174	048A11O11042	X074	✓	180
5KH33JN3121	HG138	✓	102	5KH37PNA233	HG695	✓	169	5KH39QN9725T	4730	✓	174	048A11O11063	X075	✓	180
5KH33JN3121S	H139	✓	102	5KH37PNA479X	HG714	✓	119	5KH39QN9767X	HG694	✓	170	048A11O11064	X073	✓	180
5KH33JNA500S	X1904	✓	102	5KH37PNA569T	HG706	✓	170	5KH39QNA039	4390	✓	170	048A11O11066	X077	✓	180
5KH33JNA511T	HG710	✓	26	5KH38SNA731T	HG715	✓	170	5KH39QNB810	H645	✓	25	048A11O1109	X222	✓	181
5KH33JNA534T	4735	✓	174	5KH39CN5501X	H641	✓	119	5KH42GN0336	B1507	✓	172	048A11O1167	X258	✓	168
5KH33KN20S	H277	✓	102	5KH39CN5504X	H642	✓	119	5KH42GN0337	HG143	✓	102	048A11O1239	X268	✓	177,186
5KH33KN5594	H673	✓	26	5KH39DNA533T	4733	✓	174	5KH42JN0328	H276	✓	102	048A11O1350	X018	✓	166
5KH35FN124	H114	✓	169	5KH39EN2506X	H440	✓	120	5KH42JN0328S	H247	✓	102	048A11O1351	X019	✓	166
5KH35FN124X	HG115	✓	169	5KH39EN2552X	H439	✓	120	5KH46JN0329X	H693	✓	26	048A11O1352	X020	✓	166
5KH35FN153T	4798	✓	169	5KH39EN2887X	H685	✓	120	5KH46MN3021X	HG155	✓	169	048A11O1353	X021	✓	166
5KH35GNA229	H676	✓	23	5KH39QN5508	4369	✓	26	5KH46MN3025	H173	✓	170	048A11O1375	X426	✓	161,177
5KH35HN9	H229	✓	23	5KH39QN5508X	4310	✓	26	5KH46MN3025X	H174	✓	170	048A11O1410	X295	✓	186
5KH35JN26	H166	✓	170	5KH39QN5511X	4305	✓	169	5KH46MN3040	H225	✓	174	048A11O1461	X431	✓	164
5KH35JN26X	H167	✓	170	5KH39QN5512T	4701	✓	169	5KH46MN3041	H207	✓	174	048A11O1524	X213	✓	160
5KH35JN121	H217	✓	174	5KH39QN5523	4359	✓	25	5KH46MN6053	H162	✓	169	048A11O1525	X214	✓	161
5KH35JN121X	H218	✓	174	5KH39QN5524	4377	✓	26	5KH46MN6053X	H163	✓	169	048A11O1526	X221	✓	161
5KH35JN132T	4682	✓	170	5KH39QN5525	4355	✓	169	5KH46MN6071	H214	✓	174	048A11O1583	X023	✓	166
5KH35JN602X	HG690	✓	25	5KH39QN5526X	4363	✓	169	5KH46MN6071X	H215	✓	174	048A11O1596	X444	✓	161
5KH35JN603X	H689	✓	23	5KH39QN5528X	4381	✓	26	5KH46NN3039T	HG705	✓	170	048A11O1642	X447	✓	163
5KH35JNA231	H674	✓	26	5KH39QN5529	4371	✓	26	5KH46PN3033	HG191	✓	172	048A11O1643	X446	✓	163
5KH35JNA723X	H917	✓	170	5KH39QN5529X	4311	✓	26	5KH46PN3034	H293	✓	172	048A11O1674	X033	✓	166,184
5KH35LNB164X	HG456	✓	34	5KH39QN5537X	4306	✓	169	5KH46PN6059	HG186	✓	172	048A11O1732	X445	✓	163
5KH35MN132	H197	✓	102	5KH39QN5538X	4350	✓	169	5KH48UN6054X	H298	✓	170	048A11O1744	X405	✓	181
5KH35MN132S	H198	✓	102	5KH39QN5539T	4776	✓	26	5KH48UN6074	H221	✓	174	048A11O1755	X004	✓	166
5KH35MN56	B1504	✓	172	5KH39QN5541X	4364	✓	25	5KH49MN3035	H190	✓	172	048A11O1756	X005	✓	166
5KH35MN56X	H236	✓	172	5KH39QN5543	4304	✓	169	5KH49MN6057	H136	✓	102	048A11O1769	X002	✓	166
5KH35MNA519T	HG703	✓	170	5KH39QN5548	4360	✓	169	5KH49MN6057S	H137	✓	102	048A11O1770	X455	✓	161
5KH35MNA568T	HG704	✓	169	5KH39QN5550X	4404	✓	178,185	5KH49MN6060	HG182	✓	172	048A11O1771	X453	✓	161
5KH36DNA780X	HG716	✓	178	5KH39QN5558T	4722	✓	178,185	5KH49PN3026	H175	✓	170	048A11O1772	X036	✓	167
5KH36JNA769	H905	✓	22	5KH39QN9091	H230	✓	23	5KH49PN3026X	H176	✓	170	048A11O1773	X034	✓	167
5KH36JNA769X	H906	✓	22	5KH39QN9105	B1502	✓	172	5KH49PN3042	H226	✓	174	048A11O1774	X035	✓	167
5KH36KN112	H206	✓	174	5KH39QN9105X	H234	✓	172	5KH49PN3042X	H282	✓	174	048A11O1798	X000	✓	166
5KH36KN112X	H287	✓	174	5KH39QN9397	4368	✓	23	5KH49PN3043	H620	✓	169	048A11O1799	X001	✓	166
5KH36KN113X	HG154	✓	169	5KH39QN9405X	4392	✓	170	5KH49PN3045	H275	✓	170	048A11O1874	X038	✓	167
5KH36KN114	H169	✓	169	5KH39QN9429T	4319	✓	169	5KH49PN3047	H222	✓	174	048A11O1875	X039	✓	167
5KH36KN114X	H170	✓	169	5KH39QN9508Y	HG646	✓	100	5KH49PN6055	H168	✓	170	048A11O1876	X037	✓	166
5KH36KNB633X	H344	✓	119	5KH39QN9513X	4383	✓	170	5KH49PN6055X	HG621	✓	170	048A11O2001	X006	✓	166
5KH36LN488X	H691	✓	23	5KH39QN9514X	4309	✓	170	5KH49PN6056	HG142	✓	102	048A11O2007	X090	✓	161
5KH36LN489X	HG692	✓	26	5KH39QN9518X	4602	✓	26	5KH49PN6056S	HG699	✓	102	048A11O2009	X062	✓	168
5KH36LNA504	H696	✓	23	5KH39QN9537X	4349	✓	21	5KH49PN6069	H219	✓	174	048A11O2011	X064	✓	168
5KH36MN137	H290	✓	174	5KH39QN9538	4354	✓	21	5KH49SN3023X	H288	✓	174	048A11O2012	X065	✓	168
5KH36MN3106	H286	✓	170	5KH39QN9541T	4338	✓	170	5KH49SN3046	H296	✓	169	048A11O2013	X066	✓	168
5KH36MN3106X	H248	✓	170	5KH39QN9542	4351	✓	23	5KH49SN3048	H300	✓	169	048A11O2014	X067	✓	168
5KH36MN3127T	4684	✓	170	5KH39QN9543	4373	✓	23	5KH49SN3049	H224	✓	174	048A11O2015	X068	✓	168
5KH36MNA445X	H684	✓	119	5KH39QN9544X	4393	✓	170	5KH49UN3024X	H280	✓	174	048A11O2016	X099	✓	161
5KH36MNA735X	H919	✓	170	5KH39QN9546	4372	✓	23	5KH49UN6064	HG188	✓	172	048A11O2017	X400	✓	161
5KH36MNB637X	H926	✓	119	5KH39QN9547	4376	✓	23	5KHC37NNA167T	HG700	✓	170	048A11O2022	X061	✓	168

Index

Model Number/Catalog Number

MODEL NO.	CAT. NO.	STOCK	PAGE NO.	MODEL NO.	CAT. NO.	STOCK	PAGE NO.	MODEL NO.	CAT. NO.	STOCK	PAGE NO.	MODEL NO.	CAT. NO.	STOCK	PAGE NO.
048A11O2024	X070	✓	168	048A17O69	X040	✓	168	048C17F11007	F1203	✓	100	056A8O5	X208	✓	161
048A11O2026	X071	✓	168	048A17O70	X041	✓	168	048C34D2024	O010	✓	175	056B11F5302	G579	✓	33
048A11O2028	X063	✓	168	048A17O123	X475	✓	167	048C34D2025	G091		21	056B11F5303	G578	✓	33
048A11O2029	X087	✓	160	048A17O124	X476	✓	167	048C34D2028	O011	✓	175	056B11G5301	G655	✓	34
048A11O2031	X081	✓	160	048A17O125	X211	✓	166,182	048C34S24	O012	✓	175	056B17D56	K016	✓	187,193
048A11O2032	X088	✓	161	048A17O128	X477	✓	167	048C34S2001	O013		175	056B17D67	B353	✓	171
048A11O2034	X083	✓	160	048A17O136	X230	✓	177,182	048N17D14	B703	✓	170	056B17D2010	G919	✓	21
048A11O2035	X089		161	048A17O147	X269	✓	177,183	048S17D997	B400	✓	159	056B17D2011	G250	✓	27
048A11O2046	X010	✓	166	048A17O149	X270	✓	177,185	048S17D2017	D107	✓	169	056B17D2012	G156	✓	24,171
048A11O2047	X219	✓	166	048A17O151	X015	✓	166	048S17D2042	S102	✓	25	056B17D2013	B609	✓	171
048A11O2050	X223	✓	181	048A17O152	X013	✓	166	048S17D2052	B300	✓	169	056B17D5303	G274	✓	27
048A11O2051	X417	✓	166	048A17O153	X016	✓	166	048S17D2053	B322	✓	169	056B17D5319	G979		193
048A11O2052	X418	✓	166	048A17O154	X014	✓	166	048S17D2054	B302	✓	169	056B17D5322	K232	✓	193
048A11O2053	X419	✓	166	048A17O155	X017	✓	166	048S17D2055	B303	✓	169	056B17D5323	G958	✓	193
048A11O2054	X424	✓	161	048A17O161	X273		181	048S17D2056	B304	✓	170	056B17D5328	G290	✓	193
048A11O2055	X423	✓	160	048A17O169	X420	✓	160	048S17D2057	B305	✓	170	056B17D5331	B352	✓	25,171
048A11O2059	X298	✓	161	048A17O172	X422	✓	161	048S17D2058	B306	✓	170	056B17D5701	B332		171
048A11O2062	X441	✓	161	048A17O174	X022	✓	166	048S17D2059	B307	✓	170	056B17D5703	B335	✓	171
048A11O2063	X443	✓	161	048A17O250	X454	✓	161	048S17D2086	D143	✓	170	056B17F5302	G378	✓	30,194
048A11O2064	X442	✓	161	048A17O2001	X058	✓	168	048S17D2087	D162	✓	170	056B17F5305	G574	✓	33
048A11O2065	X440	✓	161	048A17O2002	X059		168	048S17D2088	D163	✓	170	056B17F5306	G575	✓	33
048A11O251	X260	✓	182	048A17O2003	X060		168	048S17D2089	S003	✓	23	056B17F5307	F105	✓	99
048A11O653	X042	✓	168	048A17O2004	X069		168	048S17D2090	S006	✓	23	056B17F5310	G396	✓	194
048A11O654	X043	✓	168	048A17O2005	X011	✓	160,166	048S17D2091	S103		25	056B17F5319	K319	✓	32,99,194
048A11O655	X044	✓	168	048A17O2006	X012	✓	160,166	048S17D2093	S106	✓	26	056B17F5324	X902		101
048A11O656	X045	✓	168	048A17T72	X301	✓	178	048S17D2104	S126	✓	25	056B17F5328	T018	✓	195
048A11O678	X085	✓	161	048A17T86	X466	✓	162	048S17D2105	S127	✓	26	056B17F5329	T030	✓	195
048A11O694	X237		166,181	048A17T87	X467	✓	162	048S17D2106	S128	✓	26	056B17F5330	D404	✓	97
048A11O697	X241	✓	166,181	048A17T96	X468	✓	162	048S17D2107	B206	✓	169	056B17F5584	F135	✓	32,99
048A11O699	X236	✓	166,181,184	048A17T118	X030	✓	101	048S17D2108	B207	✓	170	056B17F15516	F1205	✓	100
048A11O756	X242	✓	166,181	048A17T119	X032	✓	101	048S17D2109	B208	✓	170	056B17T20	X913	✓	101
048A11O772	X048		168	048A17T237	X031	✓	101	048S17D2113	S026	✓	23	056B17T5303	X912	✓	101
048A11O773	X049	✓	168	048A17T356	X463	✓	162	048S17D2116	B606	✓	169	056B17V5301	N272	✓	113
048A11O774	X050	✓	168	048A17T359	X464	✓	162	048S17D2117	B607	✓	170	056B17V5302	N273	✓	113
048A11O775	X052	✓	168	048A17T2001	X305	✓	178	048S17D7204	D180		169	056B17V5303	N283	✓	113
048A11O787	X009	✓	166	048A17T2002	X024	✓	101	048S17D7205	D181	✓	170	056B17V5304	N285	✓	113
048A11O840	X096	✓	161	048A17T2003	X025	✓	101	048S17D7209	B402	✓	159	056B34D2018	K212		193
048A11O885	X470	✓	184	048A17T2004	X026	✓	101	048S17S24	O003	✓	175	056B34D2021	G987		193
048A11O900	X057		168	048A17T2005	X920	✓	186	048S17S25	O002	✓	175	056B34D2023	G258		27
048A11O901	X056	✓	168	048A17T2006	X921	✓	186	048S17T286	O600	✓	175	056B34D2026	G937	✓	22
048A11O2042	X003	✓	166	048A17T2007	X922	✓	186	048S17T290	O601	✓	175	056B34D2027	D115	✓	25,171
048A11T198	X303	✓	178	048A34SU1001	O701	✓	175	048S17T365	X911	✓	104	056B34D2028	O231	✓	176
048A11T199	X302	✓	178	048A8O151	X261	✓	182	048S17T366	X910	✓	104	056B34D2029	D010	✓	21,187,193
048A11T201	X304	✓	178	048A8O181	X098	✓	161	048S17T2004	X909	✓	104	056B34D2031	G254	✓	27
048A11T276	X469	✓	162	048A8O182	X097	✓	160	048S34S361	O100	✓	175	056B34D2033	J058	✓	121
048A11T463	X430	✓	162	048A8O183	X209	✓	166,184	048S34S2003	O004	✓	175	056B34D5302	D017	✓	22,187
048A11T509	X297	✓	161,184	048A8O206	X278	✓	161,184	048S34S2004	O005	✓	175	056B34D5304	G976		193
048A11T529	X413	✓	162	048A8O2001	X086	✓	161	048S34S2005	O102	✓	175	056B34D5307	G294		193
048A11T569	X412	✓	162	048A8T71	X450	✓	162	048T17D2000	G044	✓	36	056B34D5319	G272	✓	27
048A11T571	X414	✓	162	048A8T72	X451	✓	162	048T17V2001	N460	✓	114	056B34D5320	K152		25
048A11T578	X456	✓	162	048A8T73	X452	✓	162	048T17V2002	N461	✓	114	056B34D5334	G996		193
048A11T579	X457	✓	162	048A8T1002	X465	✓	162	048T17V11001	N701	✓	118	056B34D5336	K219		193
048A11T580	X458	✓	162	048C17D2023	S010	✓	23	048T17V11002	N704	✓	118	056B34D5337	O232		176
048A11T581	X459	✓	162	048C17D2024	S011	✓	23	52A101229AAG1	A549	✓	218	056B34D5341	J059	✓	121
048A11T619	X462	✓	162	048C17D2027	S030	✓	23	52A103486G1	A964	✓	219	056B34F5303	K332		194
048A11T646	X072	✓	179	048C17D2028	S110	✓	26	52D310814AAP1	A942	✓	219	056B34F5306	K612	✓	194
048A11T2008	X411	✓	184	048C17D2029	S111	✓	26	52D310822ACP1	A962	✓	219	056B34F5312	K615	✓	194
048A11T2012	X415	✓	162	048C17D2034	G078	✓	21	52D310833AAP001	A940	✓	219	056B34F5318	K618	✓	194
048A11T2013	X416	✓	162	048C17D2041	B312	✓	171	52D311808ARP1	A941	✓	219	056B34F5319	G533	✓	31
048A11T2017	X427	✓	162	048C17D2042	B313	✓	171	52D311819ABP1	A963	✓	219	056B34F5320	G374	✓	30
048A11T2020	X429	✓	162	048C17D2043	B314	✓	171	056A11O29	X432	✓	162	056B34F5321	G391	✓	30
048A11T2021	X027	✓	101	048C17D2044	B315	✓	171	056A11O30	X433	✓	162	056B34F5322	K350		30
048A11T2022	X028	✓	101	048C17D2045	S118	✓	25	056A11O5305	X271	✓	163	056B34F5324	K631		32
048A11T2023	X029	✓	101	048C17D2046	S119	✓	25	056A11O5310	X207	✓	163	056B34F5326	D314	✓	33
048A11T2024	X923	✓	186	048C17D2055	D119	✓	171	056A11O5311	X206	✓	163	056B34F5327	D315	✓	33
048A11T2025	X924	✓	186	048C17D2057	X600		183	056A11O5313	X218	✓	185	056B34F5328	D316	✓	33
048A11T2026	X925	✓	186	048C17F11005	F1201	✓	100	056A11O5314	X448	✓	163	056B34F5332	T017	✓	195
048A11T11006	X076	✓	179	048C17F11006	F1202	✓	100	056A11O5315	X449		163	056B34F5333	T019	✓	195

Model Number/Catalog Number

MODEL NO.	CAT. NO.	STOCK	PAGE NO.	MODEL NO.	CAT. NO.	STOCK	PAGE NO.	MODEL NO.	CAT. NO.	STOCK	PAGE NO.	MODEL NO.	CAT. NO.	STOCK	PAGE NO.
056B34W5301	N286	✓	113	056C17F5358	F131	✓	32,99	056C34F5327	K339		29	056H17F2017	Y362	✓	84
056C11D5304	G278	✓	27,174	056C17F5912	F132	✓	32,99	056C34F5339	T015	✓	195	056H17F2018	Y376	✓	84
056C11F5302	G577	✓	33	056C17F5913	F133	✓	32,99	056C34F5340	T013	✓	195	056H17F2019	Y365	✓	84
056C11F5303	G576	✓	33	056C17F5914	F134	✓	32,99	056C34G5308	G653	✓	34	056H17F2020	Y379	✓	84
056C11G5303	K033	✓	34	056C17F5955	G381	✓	194	056C34G5309	G656		34	056H17F2021	Y364	✓	84
056C11G5306	G650	✓	34	056C17F5956	G382	✓	194	056C34G5310	G658		34	056H17F2022	Y378	✓	84
056C11G5307	G652	✓	34	056C17F5957	G380		194	056C34G5311	G854		35	056H17T2001	Y592	✓	86
056C17D2010	G095	✓	21	056C17G5308	K037		34	056C34G5314	G873	✓	35	056H17T2011	Y500	✓	84
056C17D2025	G151	✓	24,171	056C17G5315	G651	✓	34	056C34G5315	G875		35	056H17T2012	Y501	✓	84
056C17D2044	G234	✓	27	056C17G5316	G654	✓	34	056C34G5316	G858		35	056H17T2013	Y502	✓	84
056C17D2051	S013	✓	23	056C17G5317	G657	✓	34	056C34V5301	N284	✓	113	056H17T2014	Y503	✓	84
056C17D2054	S014	✓	23	056C17G5318	G659	✓	34	056C34V5302	N281	✓	113	056H17T2015	Y504	✓	84
056C17D2055	S015	✓	23	056C17G5320	G853	✓	35	056C34W5301	N530	✓	105	056H17T2016	Y505		84
056C17D2060	S114	✓	26	056C17G5321	G855	✓	35	056C34W5302	N532	✓	105	056H17T2017	Y360	✓	84
056C17D2061	S115	✓	26	056C17G5322	G857	✓	35	056C34W5303	N524	✓	105	056H17T2018	Y374	✓	84
056C17D2064	S033	✓	23	056C17G5323	G870	✓	35	056C34W5304	N526	✓	105	056H17T2019	Y361		84
056C17D2067	S036	✓	23	056C17G5324	G871	✓	35	056C34W5305	N528	✓	105	056H17T2020	Y375		84
056C17D2072	B317	✓	24,171	056C17G5326	G874	✓	35	056C34W5307	N558	✓	105	056H17T2021	Y605	✓	84
056C17D2073	B318	✓	24,171	056C17G5327	G876	✓	35	056C34W5308	N540	✓	105	056H17T2022	Y606	✓	84
056C17D2074	B319	✓	24,171	056C17G5328	G872	✓	35	056C34W5309	N542	✓	105	056H17T5301	Y534	✓	86
056C17D2079	D111	✓	24,171	056C17V5301	N282	✓	113	056C34W5310	N544	✓	105	056H17T5302	Y535	✓	86
056C17D2084	G212	✓	27	056C17V5302	N271	✓	113	056C34W99003	N546	✓	105	056H17T5311	Y555	✓	86
056C17D2085	G230	✓	27	056C17V5303	N280	✓	113	056C34WD5301	N340	✓	110	056H17T5312	Y556	✓	86
056C17D2088	G135	✓	24,171	056C17V5304	N270	✓	113	056C34WD5302	N342	✓	110	056H17T15526	Y280	✓	85
056C17D2097	S112	✓	26	056C17W5326	N531	✓	105	056C34WD5303	N344	✓	110	056H17T15527	Y282	✓	85
056C17D2098	S012	✓	23	056C17W5327	N523	✓	105	056C34WD5304	N346	✓	110	056H17T15528	Y281	✓	85
056C17D2099	S113	✓	26	056C17W5328	N525	✓	105	056E17F1001	Z602	✓	92	056PNRA10100	SY001	✓	91
056C17D2101	X601	✓	183	056C17W5329	N527	✓	105	056E17F1002	Z603	✓	92	056PNRA10101	SY003	✓	91
056C17D2102	X602	✓	183	056C17W5330	N529	✓	105	056E17F1003	Z604	✓	92	056PNRA10102	SY004	✓	91
056C17D2113	B608	✓	171	056C17W5331	N557	✓	105	056E17F1004	Z605	✓	92	056PNRA10103	SY005	✓	91
056C17D2114	K234		28	056C17W5332	N559	✓	105	056E17F1005	Z606	✓	92	056S17D2023	S120	✓	26
056C17D2115	K235	✓	28	056C17W5333	N541	✓	105	056E17F1006	Z607	✓	92	056S17D2046	S022	✓	23
056C17D5308	G951	✓	22,187	056C17W5334	N543	✓	105	056E17F1007	Z610	✓	92	056S17D2047	B201	✓	169
056C17D5310	G256	✓	27	056C17W5335	N545	✓	105	056E17F1008	Z611	✓	92	056S17D2048	B202	✓	170
056C17D5311	G270	✓	27	056C17W5336	N680	✓	105	056E17F2005	Z612	✓	92	056S17D2049	B200	✓	170
056C17D5319	S037	✓	23	056C17W5337	N681	✓	105	056E17F2006	Z613	✓	92	056S17D2050	D149	✓	170
056C17D5320	S039	✓	23	056C17W5338	N682	✓	105	056E17F2007	Z614	✓	92	056S17D2062	B401	✓	159
056C17D5339	S116	✓	26	056C17W5327	N341	✓	110	056E17F2008	Z666	✓	93	056S17D2064	B100	✓	170
056C17D5340	S117	✓	26	056C17W5328	N343	✓	110	056E17F2009	Z667	✓	93	056S17D2066	S027	✓	23
056C17D5343	S038	✓	23	056C17W5329	N345	✓	110	056E17F2010	Z668	✓	93	056S17F5303	B506		172
056C17D5346	X603	✓	183	056C17W5330	N347	✓	110	056E17F2011	Z669	✓	93	056S34D93	O201	✓	176
056C17D5347	B336	✓	25,171	056C34D2098	O212	✓	176	056E17F2014	Z670	✓	93	056S34D2000	O200	✓	176
056C17D5348	B337	✓	171	056C34D2099	O213	✓	176	056E17F2015	Z671	✓	93	056T11D5209	X235	✓	182
056C17D5349	B338	✓	171	056C34D2100	G915	✓	21	056E17T2001	Z660	✓	93	056T11D5301	G061	✓	36
056C17E5302	K032		34	056C34D2101	G238	✓	27	056E17T2002	Z662	✓	93	056T11D5302	G067	✓	36
056C17E5314	G639	✓	34	056C34D2104	O214	✓	176	056E17T2003	Z663	✓	93	056T11D5303	G088		36
056C17E5319	G852	✓	35	056C34D2105	O217	✓	176	056E17T2004	Z664	✓	93	056T11D5304	K007		37
056C17F15537	F1204	✓	100	056C34D2106	D118	✓	24,171	056E17T2005	Z665		93	056T11F5307	K701	✓	53
056C17F2049	G332	✓	29	056C34D2108	G232	✓	27	056E17V2001	Z630	✓	93	056T11F5308	G589	✓	53
056C17F2051	G339	✓	29	056C34D2109	O211	✓	176	056E17V2002	Z631		93	056T11F5309	G588	✓	53
056C17F2052	G314	✓	29	056C34D2112	O215	✓	176	056E17V2003	Z634	✓	93	056T11F5310	G587	✓	53
056C17F5308	G356	✓	29	056C34D2114	O210	✓	176	056E17V2004	Z635	✓	93	056T11F5311	G586	✓	53
056C17F5311	G373	✓	30,194	056C34D2117	G216	✓	27	056E17V2005	Z636	✓	93	056T11F5320	K404		51
056C17F5320	G570	✓	33	056C34D2118	J054	✓	121	056E17V2006	Z637		93	056T11F5321	K407		51
056C17F5321	G571	✓	33	056C34D2119	J055	✓	121	056E17W2001	Z638	✓	93	056T11F5325	D451	✓	98
056C17F5322	G572	✓	33	056C34D2120	J056	✓	121	056E17W2002	Z639	✓	93	056T11F5326	D453	✓	98
056C17F5323	G573	✓	33	056C34D2121	J057	✓	121	056E17W2003	Z641		93	056T11F5327	D455	✓	98
056C17F5324	F101	✓	99	056C34F5301	D311	✓	33	056H17E5301	Y600	✓	87	056T11F5328	K700	✓	54
056C17F5325	F102	✓	99	056C34F5302	D312	✓	33	056H17E5302	Y601	✓	87	056T11O15	X259	✓	183
056C17F5326	F103	✓	99	056C34F5303	D313	✓	33	056H17E5303	Y602	✓	87	056T11O5300	X500	✓	165
056C17F5327	F104	✓	99	056C34F5307	G393	✓	29	056H17E5304	Y603	✓	87	056T11O5301	X501	✓	165
056C17F5349	T016	✓	195	056C34F5308	G352	✓	29	056H17E5305	Y604	✓	87	056T11O5302	X502	✓	165
056C17F5350	T014	✓	195	056C34F5309	G379	✓	29,194	056H17F2011	Y506	✓	84	056T11O5303	X503	✓	165
056C17F5351	T010	✓	195	056C34F5310	G359	✓	30	056H17F2012	Y507		84	056T11O5304	X509	✓	165
056C17F5352	D400	✓	97	056C34F5311	G390	✓	30,194	056H17F2013	Y508		84	056T11O5305	X513	✓	164
056C17F5353	D401	✓	97	056C34F5322	G514		31	056H17F2014	Y521		84	056T11O5306	X523	✓	164,177
056C17F5354	D402	✓	97	056C34F5323	G516	✓	31	056H17F2015	Y363		84	056T11O5307	X524	✓	165
056C17F5355	D403	✓	97	056C34F5324	G518	✓	31	056H17F2016	Y377		84	056T11O5308	X522	✓	165

Index

Model Number/Catalog Number

MODEL NO.	CAT. NO.	STOCK	PAGE NO.	MODEL NO.	CAT. NO.	STOCK	PAGE NO.	MODEL NO.	CAT. NO.	STOCK	PAGE NO.	MODEL NO.	CAT. NO.	STOCK	PAGE NO.
056T11O5309	X526	✓	165	056T17D15528	K081	✓	37	056T17V5355	N389	✓	116	056T34D5366	J050	✓	122
056T11O5310	X525	✓	164,177	056T17E5308	G646	✓	76	056T17V5356	N464A	✓	114	056T34D5367	J048	✓	122
056T11O11001	X532	✓	164	056T17E5309	G647	✓	76	056T17V15501	N620A	✓	108	056T34D5368	J047	✓	122
056T11O11002	X533	✓	164	056T17E5310	G827	✓	77	056T17V99002	N375	✓	109	056T34D5369	J051	✓	122
056T11O15511	X512	✓	164	056T17E5311	G828	✓	77	056T17V99003	N371	✓	109	056T34D5370	J052	✓	122
056T11V5376	N568	✓	108	056T17E5312	G842	✓	77	056T17V99004	N373	✓	109	056T34D5371	J053	✓	122
056T11V5377	N600	✓	108	056T17E5313	G843	✓	77	056T17V99005	N357	✓	109	056T34D6001	U244	✓	42
056T11V5379	N180A	✓	115	056T17E5314	G664	✓	76	056T17V99006	N351	✓	109	056T34F5301	D391	✓	53
056T11V5380	N181A	✓	115	056T17E5315	G665	✓	76	056T17V99007	N353	✓	109	056T34F5302	D392	✓	53
056T11VD5385	N495	✓	112	056T17F2043	G304	✓	47	056T17V99008	N355	✓	109	056T34F5303	D393	✓	53
056T11VD5378	N426	✓	111	056T17F2045	G328	✓	47	056T17V99009	N377	✓	109	056T34F5304	D394	✓	54
056T11VD5379	N427	✓	111	056T17F2047	K405	✓	51	056T17V99011	N708	✓	118	056T34F5305	D395	✓	54
056T11W5377	N604	✓	108	056T17F2051	G565	✓	53	056T17V99012	N711	✓	118	056T34F5306	D396	✓	54
056T11W5378	N608	✓	108	056T17F5302	G347	✓	47	056T17V99013	N761	✓	118	056T34F5308	G569	✓	53
056T11W5379	N182A	✓	115	056T17F5320	G548	✓	51	056T17V99014	N758	✓	118	056T34F5321	P102	✓	51,123
056T11W5380	N183A	✓	115	056T17F5321	G581	✓	53	056T17V99015	N755	✓	118	056T34F5322	P103	✓	51,123
056T11WD5379	N429	✓	111	056T17F5322	G582	✓	53	056T17V99016	N705	✓	118	056T34F5323	P104	✓	51,123
056T11WD5386	N497	✓	112	056T17F5323	G583	✓	53	056T17VD5326	N410	✓	112	056T34F5324	P105	✓	51,123
056T11WD5387	N498	✓	112	056T17F5324	G584	✓	54	056T17VD5327	N412	✓	112	056T34F5325	P106	✓	51,123
056T17D2092	K004	✓	36	056T17F5325	G585	✓	54	056T17VD5328	N411	✓	112	056T34F5326	P107	✓	52,123
056T17D2093	G084	✓	36	056T17F5327	G387	✓	48	056T17VD5329	N430	✓	111	056T34F5328	G308	✓	47
056T17D2094	G063	✓	36	056T17F5329	G549	✓	51	056T17VD5330	N431	✓	111	056T34F5333	G309	✓	47
056T17D2095	G047	✓	36	056T17F5330	K806	✓	54	056T17VD5331	N432	✓	111	056T34F5334	G327	✓	47
056T17D2101	G100	✓	173	056T17F5336	K705	✓	53	056T17VD5332	N428	✓	111	056T34F5335	G345	✓	47
056T17D2104	G106	✓	173	056T17F5337	K707	✓	53	056T17W5326	N653	✓	107	056T34F5336	G363	✓	48
056T17D2110	G086	✓	36	056T17F5338	K709	✓	53	056T17W5327	N611	✓	108	056T34F5337	G368	✓	48
056T17D2111	G082	✓	36	056T17F5339	K722	✓	54	056T17W5328	N313	✓	106	056T34F5338	G385	✓	48
056T17D2112	G065	✓	36	056T17F5340	K724	✓	54	056T17W5329	N291	✓	115	056T34F5342	J061	✓	123
056T17D2113	K003	✓	36	056T17F5348	D450	✓	98	056T17W5330	N468	✓	114	056T34F5343	J062	✓	123
056T17D2114	G062	✓	36	056T17F5349	D452	✓	98	056T17W5331	N465A	✓	114	056T34F5344	J063	✓	123
056T17D2115	G242	✓	40	056T17F5350	D454	✓	98	056T17W5332	N470	✓	114	056T34F5345	J064	✓	123
056T17D2116	G243	✓	40	056T17F5355	G590	✓	54	056T17W5334	N628	✓	108	056T34F5346	J065	✓	123
056T17D2117	G964	✓	173	056T17F5356	G591	✓	54	056T17W5335	N621	✓	108	056T34F5347	J066	✓	123
056T17D2118	G961	✓	173	056T17F5357	D456	✓	98	056T17W5336	N293	✓	115	056T34F5348	K704	✓	53
056T17D2119	G962	✓	173	056T17F5358	D457	✓	98	056T17W5337	N294	✓	115	056T34F5349	K706	✓	53
056T17D2120	G963	✓	173	056T17G5312	G649	✓	76	056T17W5339	N623	✓	108	056T34F5350	K708	✓	53
056T17D2121	G162	✓	173	056T17G5313	G661	✓	76	056T17W5340	N320	✓	106	056T34F5351	K721	✓	54
056T17D2127	G244	✓	40	056T17G5314	G663	✓	76	056T17W5341	N627	✓	108	056T34F5352	K723	✓	54
056T17D2128	G046	✓	36	056T17G5315	G829	✓	77	056T17W5344	N322	✓	106	056T34F5353	K725	✓	54
056T17D2130	K049	✓	37	056T17G5316	G840	✓	77	056T17W99002	N669	✓	107	056T34F5940	E2000	✓	60
056T17D3301	K063	✓	36	056T17G5317	G841	✓	77	056T17W99003	N666	✓	107	056T34F15940	E2100	✓	56
056T17D3302	K064	✓	37	056T17G5318	G844	✓	77	056T17W99004	N633	✓	108	056T34F16001	E2150	✓	56
056T17D3303	K065	✓	37	056T17G5319	G845	✓	77	056T17W99005	N632	✓	108	056T34F16020	E2125	✓	56
056T17D3304	K066	✓	38	056T17G5320	G846	✓	77	056T17W99006	N668	✓	107	056T34G5303	G648	✓	76
056T17D3305	K067	✓	36	056T17G5321	G666	✓	76	056T17W99007	N715	✓	118	056T34G5304	G660	✓	76
056T17D3306	K068	✓	37	056T17G5322	G667	✓	76	056T17W99008	N770	✓	118	056T34G5305	G662	✓	76
056T17D3307	K069	✓	37	056T17G5323	G668	✓	76	056T17W99009	N720	✓	118	056T34T5303	D390	✓	53
056T17D3308	K080	✓	38	056T17T5305	G580	✓	53	056T17W99010	N765	✓	118	056T34T5306	P101	✓	51,123
056T17D5309	K022	✓	37	056T17T5316	K703	✓	53	056T17WD5326	N413	✓	112	056T34T5308	J060	✓	123
056T17D5310	K041	✓	37	056T17V5326	N640	✓	107	056T17WD5328	N417	✓	112	056T34T5309	K702	✓	53
056T17D5329	G122	✓	173	056T17V5327	N641	✓	107	056T17WD5329	N415	✓	112	056T34V5301	N643	✓	107
056T17D5332	G127	✓	173	056T17V5328	N642	✓	107	056T17WD5330	N433	✓	111	056T34V5302	N645	✓	107
056T17D5336	G905	✓	36	056T17V5329	N644	✓	107	056T17WD5331	N435	✓	111	056T34V5303	N648	✓	107
056T17D5339	G908	✓	36	056T17V5330	N646	✓	107	056T17WD5332	N437	✓	111	056T34V5304	N651	✓	107
056T17D5342	G921	✓	36	056T17V5331	N649	✓	107	056T17WD5336	N419	✓	112	056T34V5305	N566	✓	108
056T17D5344	G923	✓	37	056T17V5332	N564	✓	108	056T17WD5337	N496	✓	112	056T34V5306	N569	✓	108
056T17D5345	G140	✓	173	056T17V5336	N567	✓	108	056T17WD5338	N494	✓	112	056T34V5307	N601	✓	108
056T17D5346	G141	✓	173	056T17V5337	N622	✓	108	056T34D5300	K027	✓	36	056T34V5308	N605	✓	108
056T17D5347	G142	✓	173	056T17V5338	N599	✓	108	056T34D5301	G080	✓	36	056T34V5309	N609	✓	108
056T17D5348	G143	✓	173	056T17V5340	N602	✓	108	056T34D5302	K000	✓	36	056T34V5312	N440A	✓	115
056T17D5349	G144	✓	173	056T17V5342	N606	✓	108	056T34D5303	K009	✓	37	056T34V5313	N482A	✓	114
056T17D5350	G145	✓	173	056T17V5346	N309	✓	106	056T34D5304	K025	✓	37	056T34V5314	N439A	✓	115
056T17D5357	G965	✓	173	056T17V5347	N400	✓	115	056T34D5327	G205	✓	40	056T34V5315	N441A	✓	115
056T17D5369	K061	✓	37	056T17V5348	N401	✓	115	056T34D5339	G289	✓	40	056T34V5316	N480A	✓	114
056T17D5370	K062	✓	37	056T17V5349	N402	✓	115	056T34D5340	K048	✓	37	056T34V5317	N481A	✓	114
056T17D5385	G967	✓	173	056T17V5352	N463A	✓	114	056T34D5357	B193	✓	173	056T34V99001	N665	✓	107
056T17D5398	H803	✓	38	056T17V5353	N462A	✓	114	056T34D5364	X251	✓	173,182	056T34V99002	N667	✓	107
056T17D5701	G161	✓	173	056T17V5354	N388	✓	116	056T34D5365	J049	✓	122	056T34V99011	N710	✓	118

Model Number/Catalog Number

MODEL NO.	CAT. NO.	STOCK	PAGE NO.	MODEL NO.	CAT. NO.	STOCK	PAGE NO.	MODEL NO.	CAT. NO.	STOCK	PAGE NO.	MODEL NO.	CAT. NO.	STOCK	PAGE NO.
056T34V99012	N753	✓	118	080T11FH5378	R311	✓	94	112A515AKG4	AG228	✓	217	143TTDR6007	GT0403	✓	128
056T34V99013	N703	✓	118	080T11FH5406	R365	✓	96	112A515ASG2	AG229	✓	217	143TTDR6008	GT0503	✓	128
056T34V99014	N707	✓	118	080T11FH5409	R368	✓	96	112MTFC6511	R324A	✓	95	143TTDR6027	U758	✓	42
056T34V99015	N757	✓	118	080T11FH5412	R371	✓	96	112MTFC6512	R424A	✓	95	143TTDR6028	U245	✓	42
056T34V99016	N760	✓	118	080T11FH5506	R385	✓	96	112MTFC6536	R325A	✓	95	143TTDR6030	GT0401	✓	128
056T34VD5301	N450	✓	112	080T11FH5509	R388	✓	96	112MTFC6537	R425A	✓	95	143TTDR6031	GT0501	✓	128
056T34VD5302	N451	✓	112	080T11FH5512	R391	✓	96	112MTFC6576	R323A	✓	95	143TTDR6051	U418A	✓	37
056T34VD5303	N452	✓	112	080T11FH5526	R310	✓	94	113A617AG001	A948	✓	219	143TTDR6052	U417A	✓	37
056T34WD5301	N453	✓	112	080T11FH5327	R313	✓	94	113A620AYP1	A949	✓	219	143TTDR6313	E783A	✓	37
056T34WD5302	N455	✓	112	080T11FH5330	R410	✓	94	115D963P1	A947	✓	219	143TTDR14003	U129A	✓	135
056T34WD5303	N457	✓	112	080T11FH5331	R413	✓	94	115D964P1	A945	✓	219	143TTDR14004	E095	✓	125
056T34W99001	N662	✓	107	080T11FH5411	R370	✓	96	115D964P2	A946	✓	219	143TTDR14048	U123A	✓	135
056T34W99002	N631	✓	108	080T11FH5414	R373	✓	96	132MTFC6536	R331A	✓	95	143TTDR14049	K634A	✓	40
056T34W99003	N220	✓	109	080T11FH5511	R390	✓	96	132MTFC6537	R431A	✓	95	143TTDR16005	E798A	✓	42
056T34W99004	N222	✓	109	080T11FH5514	R393	✓	96	132MTFC6586	R326A	✓	95	143TTDR16006	GT2503	✓	138
056T34W99005	N224	✓	109	080T11V5326	R701	✓	117	132MTFC6587	R329A	✓	95	143TTDR16007	GT4203	✓	128
056T34W99006	N226	✓	109	080T11V5327	R710	✓	117	132STFC6501	R327A	✓	95	143TTDR16008	GT4503	✓	138
056T34W99007	N230	✓	109	080T11V5328	R721	✓	117	132STFC6502	R330A	✓	95	143TTDR16009	GT2003	✓	128
056T34W99009	N228	✓	109	080T11V5329	R723	✓	117	132STFC6503	R427A	✓	95	143TTDR16010	GT2303	✓	138
056T34W99010	N232	✓	109	080T11V5330	R730	✓	117	132STFC6504	R430A	✓	95	143TTDR16011	GT4303	✓	138
056T34W99011	N234	✓	109	080T11V5331	R703	✓	117	132STFC6526	R328A	✓	95	143TTDR16012	GT4003	✓	128
056T34W99008	N236	✓	109	080T11V5332	R731	✓	117	132STFC6527	R428A	✓	95	143TTDR16013	GT4103	✓	128
056T34W99012	N238	✓	109	080T11V5333	R711	✓	117	132STFC6586	R353A	✓	95	143TTDR16014	GT4403	✓	138
056T8O5301	X506	✓	165	080T11W5326	R704	✓	117	143TBFRS301	I220	✓	30	143TTDR16015	GT2403	✓	138
056T8O5302	X507	✓	165,177	080T11W5327	R712	✓	117	143TBFRS376	I707	✓	29	143TTDR16036	U922A	✓	37
056T8O5303	X511	✓	165	080T11W5328	R724	✓	117	143TCDR5303	I101	✓	22	143TTDR16037	E912A	✓	42
056T8O5304	X527	✓	165	080T11W5329	R732	✓	117	143TCDR5328	Z401	✓	124	143TTDR16039	GT4201	✓	128
056T8O5306	X528	✓	164,177	080T34FH5301	R312	✓	94	143TCDR5330	Z420	✓	132	143TTDR16040	GT2501	✓	138
056T8O5307	X530	✓	165	080T34FH5302	R315	✓	94	143TCFRS328	Z123	✓	99	143TTDR16041	GT4501	✓	138
056T8O5531	X529	✓	164,177	080T34FH5303	R415	✓	94	143TCWR17031	N685	✓	105	143TTDR16042	GT4001	✓	128
056T8O15504	X531	✓	164,177	080T34FH5305	R412	✓	94	143THEN8034	Y978	✓	89	143TTDR16043	GT2001	✓	128
063T11FH5326	R301	✓	94	080T34FH5413	R372	✓	96	143THTN8028	Y525	✓	88	143TTDR16044	GT2301	✓	138
063T11FH5327	R401	✓	94	080T34FH5416	R375	✓	96	143THTN8036	Y986	✓	90	143TTDR16045	GT4301	✓	138
063T11FH5402	R361	✓	96	080T34FH5513	R392	✓	96	143THTN9001	W505	✓	71	143TTDR16046	GT4204	✓	128
063T11FH5502	R381	✓	96	080T34FH5516	R395	✓	96	143THTN9005	W506	✓	71	143TTDR16047	GT4101	✓	128
063T34FH5301	R300	✓	94	090LT11FH6326	R319A	✓	94	143THTN9026	W501	✓	71	143TTDR16048	GT2401	✓	138
063T34FH5302	R303	✓	94	090LT11FH6327	R419A	✓	94	143THTN19033	W502	✓	71	143TTDR16049	GT4401	✓	138
063T34FH5303	R400	✓	94	090LT11FH6419	R378A	✓	96	143THTRS326	Y536	✓	86	143TTDR16052	U758-P	✓	42
063T34FH5304	R403	✓	94	090LT11FH6519	R398A	✓	96	143THTR15535	Y283	✓	85	143TTFN6501	E377	✓	67
063T34FH5401	R360	✓	96	090LT11W4026	R705	✓	117	143TTDR4005	E917	✓	37	143TTFN6502	E378	✓	67
063T34FH5404	R363	✓	96	090LT11W4027	R706	✓	117	143TTDR4006	E798	✓	37	143TTFN6505	E379	✓	67
063T34FH5501	R380	✓	96	090LT11W4028	R707	✓	117	143TTDR4009	E123	✓	125	143TTFN6526	E374	✓	67
063T34FH5504	R383	✓	96	090LT34FH6301	R321A	✓	95	143TTDR4011	U132	✓	135	143TTFN6563	E375	✓	67
071T11FH5376	R302	✓	94	090LT34FH6302	R421A	✓	95	143TTDR4016	E120	✓	125	143TTFN6576	E373	✓	67
071T11FH5403	R362	✓	96	090LT34FH6420	R379A	✓	96	143TTDR4017	E122	✓	125	143TTFN8076	H457	✓	49
071T11FH5503	R382	✓	96	090LT34FH6520	R399A	✓	96	143TTDR4018	U128	✓	135	143TTFN16040	E2201-P	✓	56
071T11FH5326	R304	✓	94	090ST11FH6376	R314A	✓	94	143TTDR4019	U131	✓	135	143TTFN16539	E376	✓	67
071T11FH5327	R307	✓	94	090ST11FH6415	R374A	✓	96	143TTDR4022	E121	✓	125	143TTFR4003	E830	✓	48
071T11FH5330	R404	✓	94	090ST11FH6515	R394A	✓	96	143TTDR4023	U130	✓	135	143TTFR4015	U303	✓	130
071T11FH5331	R407	✓	94	090ST11FH6326	R316A	✓	94	143TTDR4024	E124	✓	125	143TTFR4021	U305	✓	130
071T11FH5405	R364	✓	96	090ST11FH6327	R416A	✓	94	143TTDR4025	U133	✓	135	143TTFR4028	E824	✓	47
071T11FH5408	R367	✓	96	090ST11FH6417	R376A	✓	96	143TTDR4034	E118	✓	125	143TTFR4034	U301	✓	130
071T11FH5505	R384	✓	96	090ST11FH6517	R396A	✓	96	143TTDR4035	E100	✓	125	143TTFR4040	U300	✓	130
071T11FH5508	R387	✓	96	090ST34FH6301	R318A	✓	94	143TTDR4037	U126	✓	135	143TTFR4046	U302	✓	130
071T11V5326	R700	✓	117	090ST34FH6302	R418A	✓	94	143TTDR4040	E115	✓	125	143TTFR4302	C201A	✓	51
071T11V5327	R702	✓	117	090ST34FH6418	R377A	✓	96	143TTDR4041	E117	✓	125	143TTFR4303	U304A	✓	130
071T11V5328	R720	✓	117	090ST34FH6518	R397A	✓	96	143TTDR4042	U122	✓	135	143TTFR4329	C220A	✓	51
071T11V5329	R722	✓	117	100LTC6501	R351A	✓	95	143TTDR4043	U125	✓	135	143TTFR4333	C230A	✓	51
071T134FH5301	R306	✓	94	100LTC6502	R451A	✓	95	143TTDR4046	E119	✓	125	143TTFR5302	C201	✓	51
071T134FH5302	R309	✓	94	100LTC6526	R322A	✓	95	143TTDR4047	E116	✓	125	143TTFR5333	C230	✓	51
071T134FH5303	R406	✓	94	100LTC6527	R422A	✓	95	143TTDR4048	U124	✓	135	143TTFR5376	H700	✓	47
071T134FH5304	R409	✓	94	100LTC6536	R352A	✓	95	143TTDR4049	U127	✓	135	143TTFR5582	E2003	✓	60
071T134FH5407	R366	✓	96	100LTC6537	R452A	✓	95	143TTDR4055	U922	✓	37	143TTFR6010	GT1203	✓	63
071T134FH5410	R369	✓	96	100LTC6576	R320A	✓	94	143TTDR4061	U416	✓	36	143TTFR6032	GT1201	✓	63
071T134FH5507	R386	✓	96	100LTC6577	R420A	✓	94	143TTDR5348	E901	✓	36	143TTFR15582	E2103	✓	56
071T134FH5510	R389	✓	96	100LTC6586	R317	✓	94	143TTDR5351	E912	✓	37	143TTFR15642	E2101	✓	56
080T11FH5376	R305	✓	94	111A271P111	A961	✓	219	143TTDR5376	H150	✓	36	143TTFR16001	E2153	✓	56
080T11FH5377	R308	✓	94	111A271P113	A965	✓	216	143TTDR5401	H180	✓	36	143TTFR16003	GT1403	✓	63

Index

Model Number/Catalog Number

MODEL NO.	CAT. NO.	STOCK	PAGE NO.	MODEL NO.	CAT. NO.	STOCK	PAGE NO.	MODEL NO.	CAT. NO.	STOCK	PAGE NO.	MODEL NO.	CAT. NO.	STOCK	PAGE NO.
143TFR16004	GT5203	✓	133	143TTWD14003	N483	✓	114	145THTR15540	Y284	✓	85	145TTDR5647	H952		195
143TFR16005	GT5003	✓	133	143TTWD14031	N151	✓	116	145THTR16031	Y611	✓	86	145TTDR5665	E914		37
143TFR16006	GT5103	✓	133	143TTWD14032	N467	✓	114	145THTR16032	Y612	✓	86	145TTDR5701	Y465	✓	189
143TFR16007	GT3003	✓	133	143TTWD16002	N442A	✓	115	145TTDR4003	E919	✓	37	145TTDR5702	Y466	✓	189
143TFR16008	GT5303	✓	141	143TTWD16003	N763	✓	118	145TTDR4005	U906		37	145TTDR5703	Y449	✓	189
143TFR16009	GT3303	✓	141	143TTWD16004	N713	✓	118	145TTDR4010	E133	✓	125	145TTDR5704	Y450		189
143TFR16010	GT3103	✓	133	143TTWD16031	N292	✓	115	145TTDR4011	U141		135	145TTDR5705	Y451	✓	189
143TFR16011	GT3403	✓	141	143TTWD16032	N766	✓	118	145TTDR4012	U144		135	145TTDR5706	Y452	✓	189
143TFR16012	GT5403	✓	141	143TTWD16033	N716	✓	118	145TTDR4015	E130		125	145TTDR6002	U247	✓	42
143TFR16013	GT3203	✓	133	143TTWR6028	N626A	✓	108	145TTDR4016	E132		125	145TTDR6004	GT0506	✓	128
143TFR16014	GT5503	✓	141	143TTWR14002	N202	✓	109	145TTDR4017	U140		135	145TTDR6006	GT0509	✓	129
143TFR16015	GT3503	✓	141	143TTWR14031	N203	✓	109	145TTDR4018	U143		135	145TTDR6007	GT0406	✓	128
143TFR16020	E2128		56	143TTWR14032	N201	✓	109	145TTDR4021	E131		125	145TTDR6013	GT0409	✓	129
143TFR16032	GT3101	✓	132	145TBD5302	I102	✓	22	145TTDR4022	E134		125	145TTDR6028	U759	✓	42
143TFR16038	E2151	✓	56	145TBD5303	I145		23	145TTDR4023	U142		135	145TTDR6029	U760	✓	42
143TFR16039	GT1401	✓	63	145TBD5304	Z404		124	145TTDR4024	U145		135	145TTDR6030	GT0507	✓	128
143TFR16040	E2126	✓	56	145TBD5309	Z304	✓	103	145TTDR4025	E144		125	145TTDR6031	GT0504	✓	128
143TFR16042	GT5201	✓	132	145TBD5337	I127	✓	22,187,193	145TTDR4034	E102	✓	125	145TTDR6034	GT0404	✓	128
143TFR16043	GT5401	✓	140	145TBD5345	I147	✓	25,171	145TTDR4035	E128	✓	125	145TTDR6036	GT0407	✓	128
143TFR16044	GT3501	✓	140	145TBR5301	I204		30	145TTDR4037	U138		135	145TTDR6039	U246	✓	42
143TFR16045	GT5501	✓	140	145TBR5302	I205		30	145TTDR4040	E125		125	145TTDR6076	U265	✓	42
143TFR16046	GT3201	✓	132	145TBR5303	I221	✓	30	145TTDR4041	E127		125	145TTDR6126	U420A	✓	37
143TFR16047	GT3001	✓	132	145TBR5305	C282		32	145TTDR4042	U134		135	145TTDR6127	U421A		37
143TFR16048	GT5001	✓	132	145TBR5306	C284		32	145TTDR4043	U137		135	145TTDR6132	U423A	✓	37
143TFR16049	GT3301	✓	140	145TBR5309	T031	✓	195	145TTDR4046	E136		125	145TTDR6133	U424A	✓	37
143TFR16050	GT5301	✓	140	145TBR5327	I201	✓	30	145TTDR4047	E129		125	145TTDR14007	C102A	✓	40
143TFR16051	GT3401	✓	140	145TBR5328	Z118	✓	99	145TTDR4048	U136		135	145TTDR14049	K622A	✓	40
143TFR16052	GT5101	✓	132	145TBR5333	I311		194	145TTDR4049	U139		135	145TTDR14087	C162A		40
143TFR16053	E2001A	✓	60	145TBR5334	I700	✓	30	145TTDR4051	E138	✓	125	145TTDR14088	C150A	✓	40
143TGN4020	C301A		77	145TBR5336	I702		194	145TTDR4060	E104	✓	125	145TTDR16008	U906A	✓	42
143TGN4030	U020		78	145TBR5337	C281		32	145TTDR4066	E135		125	145TTDR16010	E932A	✓	42
143TGN4062	C320A	✓	77	145TBR5341	Z128	✓	99	145TTDR4067	E137		125	145TTDR16013	GT4006	✓	128
143TGN6501	U058A	✓	79	145TBWD5301	N288	✓	113	145TTDR4068	U146		135	145TTDR16014	GT2306	✓	138
143TGN6526	U001A	✓	79	145TBWD5305	N348	✓	110	145TTDR4069	U149		135	145TTDR16015	GT2006	✓	128
143TGN6530	U020A	✓	79	145TBWD5326	N275	✓	113	145TTDR4072	E126		125	145TTDR16016	GT4506	✓	138
143TGN6532	U986A		79	145TBWD5327	N274	✓	113	145TTDR4073	E139		125	145TTDR16017	GT2506	✓	138
143TGN6551	C361A	✓	75	145TBWD5328	N289	✓	113	145TTDR4074	U148		135	145TTDR16018	GT4206	✓	128
143TGN7076	H350	✓	79	145TBWD5329	N287	✓	113	145TTDR4075	U151		135	145TTDR16019	GT4106	✓	128
143TGR16001	I506	✓	76	145TBWD5335	N349	✓	110	145TTDR4078	E785		37	145TTDR16020	GT2406	✓	138
143TGR16005	I507	✓	76	145TCDR5328	Z403		124	145TTDR4080	E934		37	145TTDR16021	GT4406	✓	138
143TGR16026	I502	✓	76	145TCDR5329	Z422		132	145TTDR4103	U905		37	145TTDR16022	GT4009	✓	129
143TGR16030	I503		76	145TCDR5331	I146	✓	25,171	145TTDR4105	E932		37	145TTDR16023	GT2009	✓	129
143TTC4026	E826	✓	49	145TCWR5326	N683	✓	105	145TTDR4110	E143		125	145TTDR16024	GT2309	✓	139
143TTN4001	E833	✓	49	145TEFR5326	Z615	✓	92	145TTDR4111	U153	✓	135	145TTDR16025	GT4309	✓	139
143TTN4003	E831		49	145TEFR5327	Z616	✓	92	145TTDR4112	U156		135	145TTDR16054	U923A		37
143TTN4005	E835		49	145THEN8034	Y979	✓	89	145TTDR4115	E140		125	145TTDR16059	U924A		37
143TTN4028	E825		49	145THFR5326	Y523		84	145TTDR4117	U152		135	145TTDR16061	E913A	✓	42
143TTN4030	E828		49	145THFR5329	Y368	✓	84	145TTDR4118	U155		135	145TTDR16062	E914A	✓	37,42
143TTN6001	E351	✓	56	145THFR5330	Y369	✓	84	145TTDR4121	E141		125	145TTDR16077	E934A	✓	42
143TTN6501	E651	✓	67	145HTN6046	Y551	✓	86	145TTDR4123	U154		135	145TTDR16073	GT4004	✓	128
143TTN6502	E463		67	145HTN6060	Y557	✓	86	145TTDR4124	U157		135	145TTDR16074	GT2004	✓	128
143TTN6505	E851		67	145HTN8029	Y526	✓	88	145TTDR4128	U419		37	145TTDR16075	GT2304	✓	138
143TTN6526	E649	✓	67	145HTN8037	Y590	✓	88	145TTDR4130	U923		37	145TTDR16301	GT2409	✓	139
143TTN6530	E666	✓	67	145HTN8043	Y987	✓	90	145TTDR4134	U422	✓	37	145TTDR16302	GT4209	✓	129
143TTN6563	E461	✓	67	145HTN9001	W511		71	145TTDR4136	U924		37	145TTDR16303	GT2509	✓	139
143TTN6576	E648	✓	67	145HTN9026	W507	✓	71	145TTDR4303	E105		125	145TTDR16304	GT4509	✓	139
143TVD5326	N403	✓	115	145HTN9027	W513	✓	71	145TTDR4307	E142		125	145TTDR16305	GT4109	✓	129
143TVD5327	N466	✓	114	145HTN9076	W503		71	145TTDR4317	E096	✓	125	145TTDR16306	GT4409	✓	139
143TVR5326	N647	✓	107	145HTN17034	Y285	✓	85	145TTDR4341	C122A	✓	40	145TTDR16307	GT4306	✓	138
143TVR5327	N650	✓	107	145HTN19002	W512		71	145TTDR4354	U135A	✓	135	145TTDR16308	U401A	✓	41
143TVR5329	N310	✓	106	145HTN19033	W514		71	145TTDR4355	U150A		135	145TTDR16326	GT4304	✓	138
143TWD4002	N456	✓	112	145HTN19045	W508		71	145TTDR4356	U147A	✓	135	145TTDR16327	GT2504	✓	138
143TWD4527	N434A	✓	111	145HTN19079	W638		71	145TTDR5312	C103	✓	40	145TTDR16328	GT4504	✓	138
145TTWD4528	N438A	✓	111	145HTTR5326	Y538	✓	86	145TTDR5315	M311	✓	125	145TTDR16329	GT4104	✓	128
143TWD6001	N454A	✓	112	145HTR5328	Y522	✓	84	145TTDR5316	M312	✓	125	145TTDR16330	GT2404	✓	138
143TWD6002	N456A	✓	112	145HTR5329	Y366	✓	84	145TTDR5401	H181	✓	36	145TTDR16331	GT4404	✓	138
143TWD6026	N414A	✓	112	145HTR5330	Y367		84	145TTDR5632	E902	✓	37	145TTDR16332	GT4107	✓	128
143TTWD14002	N152	✓	116	145HTR5376	Y537	✓	86	145TTDR5633	E903	✓	37	145TTDR16333	GT2407	✓	138

Model Number/Catalog Number

MODEL NO.	CAT. NO.	STOCK	PAGE NO.	MODEL NO.	CAT. NO.	STOCK	PAGE NO.	MODEL NO.	CAT. NO.	STOCK	PAGE NO.	MODEL NO.	CAT. NO.	STOCK	PAGE NO.
145TTDR16334	GT4407	✓	138	145TTFR16035	E2107	✓	57	145TTTN4076	E829	✓	49	161L113AAG1	AG109	✓	214
145TTDR16335	GT2007	✓	128	145TTFR16036	GT3104	✓	133	145TTTN4080	U672	✓	49	161L113AAG2	AG110	✓	214
145TTDR16336	GT4007	✓	128	145TTFR16037	GT3107	✓	133	145TTTN6001	E353	✓	57	161L113AAG3	AG111	✓	214
145TTDR16337	GT2307	✓	138	145TTFR16038	E2154	✓	56	145TTTN6501	E653	✓	67	161L113AAG4	AG112	✓	214
145TTDR16338	GT4207	✓	128	145TTFR16039	E2157	✓	57	145TTTN6505	E852	✓	67	161L113AAG5	AG113	✓	214
145TTDR16339	GT2507	✓	138	145TTFR16040	E2129	✓	56	145TTTN6521	E466	✓	67	161L113AAG6	AG114	✓	214
145TTDR16340	GT4507	✓	138	145TTFR16045	E2132	✓	57	145TTTN6526	E652	✓	67	161L113AAG9	AG115	✓	214
145TTDR16342	GT4307	✓	138	145TTFR16046	GT1404	✓	63	145TTTN6527	E654	✓	68	161L113ADG1	AG125	✓	214
145TTDR16348	U759-P	✓	42	145TTFR16047	GT1407	✓	63	145TTTN6529	E667	✓	67	161L113ADG3	AG127	✓	214
145TTDR16349	U760-P	✓	42	145TTFR16055	GT5407	✓	141	145TTTN6530	E668	✓	68	161L113ADG4	AG128	✓	214
145TTFN6501	E382	✓	67	145TTFR16056	GT3407	✓	141	145TTTN6576	E650	✓	67	161L113ADG5	AG129	✓	214
145TTFN6521	E383	✓	67	145TTFR16057	GT5107	✓	133	145TTTN6584	E462	✓	67	161L113ADG14	AG130	✓	214
145TTFN6835	E386	✓	68	145TTFR16058	GT5004	✓	133	145TTTN6834	E464	✓	67	161L185AAG1	AG212	✓	209
145TTFN16045	E2207-P	✓	57	145TTFR16059	GT3004	✓	133	145TTTN6835	E467	✓	68	161L186AAG1	AG195	✓	210
145TTFN16046	E2204-P	✓	56	145TTFR16060	GT3304	✓	141	145TTTN18531	S503	✓	191	161L187BAG1	A534	✓	209
145TTFR3002	E2006	✓	60	145TTFR16061	GT5304	✓	141	145TTTN18532	S553	✓	191	161L187BCG1	A535	✓	209
145TTFR4005	E840	✓	48	145TTFR16062	GT5204	✓	133	145TTTN18577	S501	✓	191	161L188BAG1	A536	✓	210
145TTFR4007	E843	✓	48	145TTFR16063	GT3204	✓	133	145TTVR5030	N629	✓	108	161L188BCG1	A537	✓	210
145TTFR4017	U309	✓	130	145TTFR16064	GT3504	✓	141	145TTVR5301	N652	✓	107	161L197ABG1	A958	✓	219
145TTFR4023	U311	✓	130	145TTFR16065	GT5504	✓	141	145TTVR5302	N610	✓	108	161L197ABG11	A959	✓	219
145TTFR4029	E836	✓	48	145TTFR16066	GT5007	✓	133	145TTVR5326	N607	✓	108	161L198AAG9	A956	✓	219
145TTFR4032	E845	✓	48	145TTFR16067	GT3007	✓	133	145TTWD6001	N458A	✓	112	161L198AAG10	A957	✓	219
145TTFR4038	E838	✓	48	145TTFR16068	GT3307	✓	141	145TTWD6026	N404A	✓	115	161L210AAP1	AG697	✓	219
145TTFR4039	E847	✓	48	145TTFR16069	GT5307	✓	141	145TTWD6027	N405A	✓	115	161L528AAG1	AG234	✓	218
145TTFR4045	U307	✓	130	145TTFR16070	GT5207	✓	133	145TTWD6028	N416A	✓	112	180LTC6538	R343A	✓	95
145TTFR4046	U703	✓	54	145TTFR16071	GT3207	✓	133	145TTWD6029	N418A	✓	112	180LTC6588	R338A	✓	95
145TTFR4048	U306	✓	130	145TTFR16072	GT3507	✓	141	145TTWD6030	N459	✓	112	180MTFC6511	R342A	✓	95
145TTFR4050	U312	✓	130	145TTFR16073	GT5507	✓	141	145TTWD6031	N436A	✓	111	180MTFC6536	R340A	✓	95
145TTFR4052	U705	✓	54	145TTFR16074	GT5104	✓	133	145TTWD6077	N499	✓	112	182BFRS301	I206	✓	30
145TTFR4054	U308	✓	130	145TTFR16075	GT5404	✓	141	145TTWD14002	N154	✓	116	182BFRS326	I212	✓	30
145TTFR4070	U706	✓	54	145TTFR16079	GT1202	✓	63	145TTWD14003	N156	✓	116	182TCDR7013	Z309	✓	103
145TTFR4126	U708	✓	54	145TTFR16078	E2102	✓	56	145TTWD14004	N485	✓	114	182TCDR7354	Z424	✓	132
145TTFR4128	U314	✓	130	145TTFR16080	E2127	✓	56	145TTWD14005	N484	✓	114	182TCDR8005	Z425	✓	132
145TTFR4306	C202A	✓	51	145TTFR16326	GT3404	✓	141	145TTWD14031	N153	✓	116	182TCDR8007	C173	✓	27
145TTFR4307	C236A	✓	52	145TTFR16329	E2007A	✓	60	145TTWD14032	N155	✓	116	182TCDR17079	I141	✓	21
145TTFR4310	U363	✓	131	145TTFR16331	E2004A	✓	60	145TTWD14033	N471	✓	114	182TCDW7001	I103A	✓	22
145TTFR4332	C221A	✓	51	145TTGN4022	C302A	✓	77	145TTWD14034	N469	✓	114	182TCDW7026	I112A	✓	22
145TTFR4340	C231A	✓	51	145TTGN4035	U021	✓	78	145TTWD16002	N444	✓	115	182TCDW7074	Z405A	✓	124
145TTFR4378	C250A	✓	51	145TTGN4040	U022	✓	78	145TTWD16003	N443A	✓	115	182TCDW7318	Z406A	✓	124
145TFR5340	C231	✓	51	145TTGN4337	C321A	✓	77	145TTWD16004	N718	✓	118	182CFW7072	Z119A	✓	99
145TFR5341	C232	✓	51	145TTGN4338	C322A	✓	77	145TTWD16005	N768	✓	118	182TCFW9061	Z112A	✓	100
145TFR5359	C403	✓	98	145TTGN6501	U059A	✓	79	145TTWD16031	N771	✓	118	182TCWW7026	N684A	✓	105
145TFR5360	C401	✓	98	145TTGN6526	U002A	✓	79	145TTWD16032	N721	✓	118	182TEFRS326	Z617	✓	92
145TFR5382	C400	✓	98	145TTGN6527	U003A	✓	79	145TTWR4301	N655A	✓	107	182THES8048	Y980	✓	89
145TFR6009	GT1206	✓	63	145TTGN6536	C362A	✓	75	145TTWR4326	N654A	✓	107	182THFRS329	Y370	✓	85
145TFR6040	GT1207	✓	63	145TTGN6537	U021A	✓	79	145TTWR5301	N655	✓	107	182THFRS330	Y371	✓	85
145TFR6058	GT1204	✓	63	145TTGN6540	U022A	✓	79	145TTWR6001	N613A	✓	108	182THFS19101	W504	✓	71
145TFR6078	E2002	✓	60	145TTGN6549	C363A	✓	75	145TTWR6026	N612A	✓	108	182THFW7729	Y1999	✓	85
145TFR14011	U310A	✓	130	145TTGN6550	U988A	✓	79	145TTWR6027	N312A	✓	106	182THFW7730	Y270A	✓	85
145TFR14045	U313A	✓	130	145TTGN6576	U039A	✓	79	145TTWR6029	N321A	✓	106	182THL7726	Y541	✓	86
145TFR14048	C232A	✓	51	145TTGN16532	U987A	✓	79	145TTWR6033	N630	✓	108	182THL7736	Y558	✓	86
145TFR15581	E2152	✓	56	145TTGR16002	I512	✓	76	145TTWR6076	N323	✓	106	182THL17041	Y286	✓	85
145TFR16001	E2156	✓	57	145TTGR16004	I513	✓	76	145TTWR14003	N204	✓	109	182THS8028	Y527	✓	88
145TFR16005	GT1406	✓	63	145TTGR16030	I509	✓	76	145TTWR14004	N206	✓	109	182THS8048	Y988	✓	90
145TFR16009	GT5006	✓	133	145TTGR16038	I508	✓	76	145TTWR14031	N205	✓	109	182THS9001	W517	✓	72
145TFR16010	GT3006	✓	133	145TTGR16039	I515	✓	76	145TTWR14032	N360	✓	109	182THS9026	W519	✓	72
145TFR16011	GT5306	✓	141	145TTGR16040	I514	✓	76	145TTWR14033	N362	✓	109	182THS9076	W509	✓	71
145TFR16012	GT5106	✓	133	145TTGR16076	I504	✓	76	145TTWR17031	N380	✓	109	182THS19033	W520	✓	72
145TFR16013	GT3106	✓	133	145TTGR16080	I505	✓	76	145TTWR17032	N382	✓	109	182THY7726	Y541A	✓	86
145TFR16014	GT3406	✓	141	145TTTC4026	E837	✓	49	160LTC6513	R339A	✓	95	182THY7736	Y558A	✓	86
145TFR16015	GT5406	✓	141	145TTTC4027	E846	✓	49	160LTC6538	R337A	✓	95	182THY17041	Y286A	✓	85
145TFR16016	GT3306	✓	141	145TTTN4001	E842	✓	49	160LTC6588	R335A	✓	95	182TPFSA10094	SY006	✓	91
145TFR16017	GT5206	✓	133	145TTTN4003	E841	✓	49	160MTFC6511	R333A	✓	95	182TDB6001	GT0012	✓	45
145TFR16018	GT3206	✓	133	145TTTN4005	E844	✓	49	160MTFC6512	R336A	✓	95	182TDB6007	GT0412	✓	129
145TFR16019	GT5506	✓	141	145TTTN4030	U606	✓	49	160MTFC6536	R334A	✓	95	182TDB6008	GT0512	✓	129
145TFR16020	E2131	✓	57	145TTTN4032	U601	✓	49	160MTFC6586	R332A	✓	95	182TDB6012	GT2412	✓	139
145TFR16021	GT3506	✓	141	145TTTN4035	E839	✓	49	161L110AA1	AG195	✓	215	182TDB6013	GT2512	✓	139
145TFR16033	E2104	✓	56	145TTTN4040	E848	✓	49	161L110AAG4	A518	✓	215	182TDB6026	GT0010	✓	45

Index

Model Number/Catalog Number

MODEL NO.	CAT. NO.	STOCK	PAGE NO.	MODEL NO.	CAT. NO.	STOCK	PAGE NO.	MODEL NO.	CAT. NO.	STOCK	PAGE NO.	MODEL NO.	CAT. NO.	STOCK	PAGE NO.
182TTDB6032	GT0410	✓	129	182TTFB6004	GT1309	✓	63	182TTGN6569	C364A	✓	75	184THTS9076	W515		71
182TTDB6033	GT0510	✓	129	182TTFB6006	GT3109	✓	133	182TTGN6576	U040A	✓	79	184HTY7726	Y543A	✓	86
182TTDB6037	GT2410	✓	139	182TTFB6007	GT1409	✓	64	182TTGS4030	U023		78	184HTY7736	Y559A	✓	86
182TTDB6038	GT2510	✓	139	182TTFB6008	GT3209	✓	133	182TTTL7034	C405	✓	98	184HTY17038	Y287A	✓	85
182TTDB6076	GT0005	✓	45	182TTFB6012	GT3409	✓	141	182TTTS6001	E216	✓	57	184TFPSA10095	SY007	✓	91
182TTDB6082	GT0405	✓	128	182TTFB6013	GT3509	✓	141	182TTTS6030	E303		57	184TTDB6001	GT0015	✓	45
182TTDB6085	GT2405	✓	138	182TTFB6028	GT1210	✓	64	182TTTS6501	E601	✓	68	184TTDB6007	GT0415	✓	129
182TTDB6092	GT0505	✓	128	182TTFB6029	GT1310	✓	63	182TTTS6505	E853		68	184TTDB6008	GT0515	✓	129
182TTDB6095	GT2505	✓	138	182TTFB6031	GT3110	✓	133	182TTTS6526	E616	✓	68	184TTDB6012	GT2415	✓	139
182TTDB7325	M1315	✓	126	182TTFB6032	GT1410	✓	64	182TTTS6530	E669	✓	68	184TTDB6013	GT2515	✓	139
182TTDB7601	M1316	✓	126	182TTFB6033	GT3210	✓	133	182TTTS6538	E470	✓	68	184TTDB6026	GT0013	✓	45
182TTDR4036	E147		126	182TTFB6037	GT3410	✓	141	182TTTS6576	E632	✓	67	184TTDB6032	GT0413	✓	129
182TTDR4075	U925		38	182TTFB6038	GT3510	✓	141	182TTTS6578	E465		67	184TTDB6033	GT0513	✓	129
182TTDR4104	E933		38	182TTFB6078	GT1205	✓	63	182TTTS18532	S506		191	184TTDB6037	GT2413	✓	139
182TTDR4106	U908		38	182TTFB6079	GT1305	✓	63	182TTWD6031	N406A	✓	115	184TTDB6038	GT2513	✓	139
182TTDR4113	U168		136	182TTFB6082	GT3105	✓	133	182TTWD14033	N157	✓	116	184TTDB6076	GT0008	✓	45
182TTDR4117	E152		126	182TTFB6085	GT3405	✓	141	182TTWD14032	N448A	✓	114	184TTDB6082	GT0408	✓	128
182TTDR4118	U164		136	182TTFB6092	GT3205	✓	133	182TTWW4028	N656B	✓	107	184TTDB6085	GT2408	✓	138
182TTDR4119	U167		136	182TTFB6095	GT3505	✓	141	182TTWW6026	N614B	✓	108	184TTDB6092	GT0508	✓	128
182TTDR4122	E151		126	182TTFC6001	GT1009	✓	61	182TTWW6027	N314B	✓	106	184TTDB6095	GT2508	✓	138
182TTDR4123	E154		126	182TTFC6005	GT1109	✓	61	182TTWW14031	N207	✓	109	184TTDR4034	E108	✓	126
182TTDR4124	U166		136	182TTFC6026	GT1010	✓	61	182TTWW16002	N634	✓	108	184TTDR4105	E938		38
182TTDR4125	U169		136	182TTFC6030	GT1110	✓	61	184TBDR5301	Z504		188	184TTDR4112	U180		136
182TTDR4140	E145		126	182TTFC6031	U609A	✓	57	184TBDR5326	Z502	✓	188	184TTDR4115	E160		126
182TTDR4142	U158		135	182TTFC6076	GT1005	✓	61	184TBDR7324	Z313		103	184TTDR4116	E162		126
182TTDR4143	U161		135	182TTFC6080	GT1105	✓	61	184TBDR7375	I119		188,193	184TTDR4117	U176		136
182TTDR4146	E146		126	182TTFN4101	L409A	✓	49	184TBDR7628	I305		193	184TTDR4118	U179		136
182TTDR4148	U160		136	182TTFN6557	U867A	✓	65	184TBDR7634	I308		193	184TTDR4121	E161		126
182TTDR4149	U163		136	182TTFN16047	E2210-P	✓	57	184TBDW7001	I108A	✓	22,188	184TTDR4122	E164		126
182TTDR8353	H953		195	182TTFR4013	U736		54	184TBDW7009	Z307A	✓	103	184TTDR4123	U178		136
182TTDR8067	C123	✓	40	182TTFR4015	U315		131	184TBDW7026	I114A	✓	22,188	184TTDR4124	U181		136
182TTDR14026	M803A		153	182TTFR4021	U317		131	184TBDW7369	Z124A		160	184TTDR4140	E155		126
182TTDR14027	M801A		153	182TTFR4056	U320		131	184TBDW7630	I130A	✓	193	184TTDR4141	E157		126
182TTDW4027	E1904	✓	38	182TTFS4005	U604		49	184TBDW7631	I128A	✓	193	184TTDR4142	U170		136
182TTDW4028	C123B	✓	40	182TTFS6501	E390		68	184TBDW7632	I131A	✓	193	184TTDR4143	U173		136
182TTDW4030	E1915		38	182TTFS6505	E392		68	184TBDW7656	Z506A		188	184TTDR4146	E156		126
182TTDW4083	E1799	✓	37	182TTFS6576	E380		67	184TBDW17007	Z408A	✓	124	184TTDR4147	E159		126
182TTDW4116	E150A		126	182TTFW4027	C223B	✓	52	184TBDW17008	I104A	✓	22	184TTDR4148	U172		136
182TTDW4135	E148A	✓	126	182TTFW4040	U1608	✓	48	184TBDW17011	Z427A	✓	132	184TTDR4149	U175		136
182TTDW4147	E149A		126	182TTFW4302	U316A	✓	131	184TBFW7034	I315A	✓	32,99,194	184TTDR4173	M804A		153
182TTDW4006	E098	✓	126	182TTFW4327	U605A	✓	48	184TBFW7041	I314A	✓	32,99,194	184TTDR4178	E918		37
182TTDW4304	E153A	✓	126	182TTFW4330	U319A	✓	131	184TBFW7070	Z114A	✓	100	184TTDR9040	H954	✓	195
182TTDW4325	E107A	✓	126	182TTFW4345	C383A		54	184TBFW7315	Z433A	✓	124	184TTDW4003	E937A		38
182TTDW4336	E106A	✓	126	182TTFW6001	E2009	✓	60	184TBFW7701	I223A	✓	30	184TTDW4005	E163A	✓	126
182TTDW4338	U159A	✓	135	182TTFW6026	E2010	✓	60	184TBFW7726	I214A	✓	30	184TTDW4027	E1905	✓	38
182TTDW4339	U162A		135	182TTFW6076	E2005	✓	60	184TBFW7737	Z121A	✓	99	184TTDW4030	E1916	✓	38
182TTDW6001	U1248	✓	43	182TTFW14004	C203B	✓	52	184TBFW17044	I213A	✓	30	184TTDW4039	U299		136
182TTDW6030	E1930	✓	42	182TTFW14005	M875A		157	184TBFW17045	Z120A	✓	99	184TTDW4135	E158A	✓	126
182TTDW6076	U1266	✓	42	182TTFW14026	M876A		157	184TCDR7076	I142		22	184TTDW4136	U171A		136
182TTDW7101	H182A		37	182TTFW16001	E2109	✓	57	184TCDR7626	Z426		132	184TTDW4153	U427A	✓	38
182TTDW7203	Y485A		189	182TTFW16002	E2159	✓	57	184TCDR7627	C174		27	184TTDW6001	U249A	✓	43
182TTDW7211	Y409A	✓	189	182TTFW16020	E2134	✓	57	184TCDW7026	I113A	✓	22	184TTDW6031	E1931	✓	43
182TTDW7412	Y1484	✓	189	182TTFW16021	C381B	✓	54	184TCDW7047	Z407A	✓	124	184TTDW6076	U1267	✓	42
182TTDW7411	Y467A	✓	189	182TTFW16026	E2110	✓	57	184TCDW7615	Z305A	✓	103	184TTDW7101	H183A		37
182TTDW7413	Y1453	✓	189	182TTFW16027	C383B	✓	54	184TCDW7617	Z306A	✓	103	184TTDW7209	Y1487	✓	189
182TTDW14008	C104B	✓	40	182TTFW16030	C382B	✓	54	184TCFW9057	Z113A	✓	100	184TTDW7215	Y412A	✓	189
182TTDW14011	U165A	✓	136	182TTFW16038	E2160	✓	57	184THFS9001	W523	✓	72	184TTDW7230	Y468A	✓	189
182TTDW14029	E097	✓	125	182TTFW16040	E2135	✓	57	184THFS9026	W525	✓	72	184TTDW7286	Y454A	✓	189
182TTDW16008	U908A	✓	43	182TTFW16076	E2105	✓	56	184THFS9030	W526	✓	72	184TTDW7287	Y486A	✓	189
182TTDW16009	U914	✓	42	182TTFW16080	E2130	✓	56	184THFS19006	W524	✓	72	184TTDW7357	M1317	✓	126
182TTDW16010	U402C	✓	41	182TTFW16082	E2155		56	184THFW7726	Y1372	✓	85	184TTDW7358	M115A	✓	136
182TTDW16029	E915B	✓	42	182TTGN4068	C323A	✓	77	184THFW7736	Y373A	✓	85	184TTDW7611	Y302A	✓	103
182TTDW16048	U425B		38	182TTGN4315	C303A	✓	77	184THL7726	Y543	✓	86	184TTDW7612	Y1303	✓	103
182TTDW16049	U426B	✓	38	182TTGN6501	U060A	✓	79	184THL7736	Y559	✓	86	184TTDW14001	E109A	✓	126
182TTDW16059	U410A	✓	41	182TTGN6526	U004A	✓	79	184THL7776	Y540	✓	86	184TTDW14017	C105B	✓	40
182TTDW16063	E1930-P	✓	42	182TTGN6530	U023A	✓	79	184THL17038	Y287	✓	85	184TTDW14027	C124B	✓	40
182TTDW16082	U925A		38	182TTGN6536	C368A	✓	75	184THTS8028	Y564	✓	88	184TTDW14078	C152A		40
182TTFB6003	GT1209	✓	64	182TTGN6541	U989A		79	184THTS8056	Y989	✓	90	184TTDW14079	U177A	✓	136

Model Number/Catalog Number

MODEL NO.	CAT. NO.	STOCK	PAGE NO.	MODEL NO.	CAT. NO.	STOCK	PAGE NO.	MODEL NO.	CAT. NO.	STOCK	PAGE NO.	MODEL NO.	CAT. NO.	STOCK	PAGE NO.
184TTDW16001	U404B	✓	41	184TFPW14004	C204B	✓	52	213THFS8028	Y595	✓	88	213TTDW14054	M807A		153
184TTDW16027	E938A	✓	43	184TFPW14021	C238B	✓	52	213THFS9026	W532	✓	72	213TTDW14057	C125A		40
184TTDW16038	U428B	✓	38	184TFPW14026	M879A		157	213THFS9030	W533	✓	72	213TTDW14059	U186A		136
184TTDW16040	E916B	✓	43	184TFPW14028	U326A		131	213THFS9076	W521	✓	72	213TTDW14084	M802A		153
184TTDW16041	U917		38	184TFPW16001	E2112	✓	57	213THFW7726	Y994	✓	85	213TTDW14102	H184A		37
184TTDW16043	U403A		41	184TFPW16002	E2162	✓	57	213THFW7736	Y995		85	213TTDW16010	U432A		41
184TTDW16061	E1931-P	✓	43	184TFPW16006	C385B	✓	54	213THTL7726	Y545	✓	86	213TTDW16060	U430A	✓	38
184TTDW16076	U915	✓	42	184TFPW16020	E2137	✓	57	213THTL7736	Y560	✓	86	213TTDW16061	U926A		38
184TFB6003	GT1212	✓	64	184TFPW16026	E2113	✓	57	213THTL7776	Y542	✓	86	213TTDW16063	U405A	✓	41
184TFB6004	GT1312	✓	63	184TFPW16027	C386B	✓	54	213THS8038	Y565	✓	88	284TDR16047	U430A-P	✓	43
184TFB6006	GT3112	✓	133	184TFPW16038	E2163	✓	57	213THS8071	Y990	✓	90	213TFB6006	GT3115	✓	133
184TFB6007	GT1412	✓	64	184TFPW16029	C387B	✓	54	213THS9001	W530	✓	72	213TFB6008	GT3215	✓	133
184TFB6008	GT3212	✓	133	184TFPW16040	E2138	✓	57	213THS19005	W531		72	213TFB6012	GT3415	✓	141
184TFB6012	GT3412	✓	141	184TFPW16051	C380B	✓	54	213TPFSA10096	SY008	✓	91	213TFB6013	GT3515	✓	141
184TFB6013	GT3512	✓	141	184TFPW16076	E2108	✓	57	213TTDB6001	GT0018	✓	45	213TFB6031	GT3116	✓	133
184TFB6028	GT1213	✓	64	184TFPW16079	E2158		57	213TTDB6007	GT0418	✓	129	213TFB6033	GT3216	✓	133
184TFB6029	GT1313	✓	63	184TFPW16081	E2133		57	213TTDB6008	GT0518	✓	129	213TFB6037	GT3416	✓	141
184TFB6031	GT3113	✓	133	184TTGN4072	C324A	✓	77	213TTDB6012	GT2418	✓	139	213TFB6038	GT3516	✓	141
184TFB6032	GT1413	✓	64	184TTGN4313	C304A	✓	77	213TTDB6013	GT2518	✓	139	213TFB6082	GT3111	✓	133
184TFB6033	GT3213	✓	133	184TTGN6501	U061A	✓	79	213TTDB6026	GT0016	✓	45	213TFB6085	GT3411	✓	141
184TFB6037	GT3413	✓	141	184TTGN6526	U005A	✓	79	213TTDB6032	GT0416	✓	129	213TFB6092	GT3211	✓	133
184TFB6038	GT3513	✓	141	184TTGN6530	U024A	✓	79	213TTDB6033	GT0516	✓	129	213TFB6095	GT3511	✓	141
184TFB6078	GT1208	✓	63	184TTGN6537	C369A	✓	75	213TTDB6037	GT2416	✓	139	213TFBA6003	GT1215	✓	64
184TFB6079	GT1308	✓	63	184TTGN6544	U990A		79	213TTDB6038	GT2516	✓	139	213TFBA6004	GT1315	✓	63
184TFB6082	GT1308	✓	133	184TTGN6575	C365A	✓	75	213TTDB6076	GT0011	✓	45	213TFBA6007	GT1415	✓	64
184TFB6085	GT3408	✓	141	184TTGN6576	U041A	✓	79	213TTDB6082	GT0411	✓	129	213TFBA6028	GT1216	✓	64
184TFB6092	GT3208	✓	133	184TTGS4030	U024		78	213TTDB6085	GT2411	✓	139	213TFBA6029	GT1316	✓	63
184TFB6095	GT3508	✓	141	184TTTL7041	C406	✓	98	213TTDB6092	GT0511	✓	129	213TFBA6032	GT1416	✓	64
184TFC6001	GT1012	✓	61	184TTTL7083	C404	✓	98	213TTDB6095	GT2511	✓	139	213TFBA6078	GT1211	✓	64
184TFC6005	GT1112	✓	61	184TTTL7084	C402	✓	98	213TTDBA4028	E906	✓	38	213TFBA6079	GT1311	✓	63
184TFC6006	U615A	✓	57	184TTTS6576	E633	✓	68	213TTDC6001	U764	✓	43	213TFC6001	GT1015	✓	61
184TFC6026	GT1013	✓	61	184TTTS6582	E468	✓	68	213TTDC6003	U283	✓	43	213TFC6005	GT1115	✓	61
184TFC6027	U618A	✓	57	184TTTS18577	S504		191	213TTDC6026	U763	✓	43	213TFC6006	U671A	✓	57
184TFC6030	GT1113	✓	61	184TTTS18578	S554		191	213TTDC6029	U281	✓	43	213TFC6026	GT1016	✓	61
184TFC6031	U620A	✓	57	184TTWD6031	N407A	✓	115	213TTDC6076	U268	✓	42	213TFC6027	U629A	✓	57
184TFC6076	GT1008	✓	61	184TTWD14002	N486	✓	114	213TTDC6079	U279	✓	42	213TFC6030	GT1116	✓	61
184TFC6080	GT1108	✓	61	184TTWD14003	N158	✓	116	213TTDW4003	E939		38	213TFC6031	U631A	✓	57
184TFC6081	E002	✓	57	184TTWD14032	N449A	✓	114	213TTDW4007	E174		126	213TFC6076	GT1011	✓	61
184TFN4102	L410B	✓	49	184TTWD14033	N159	✓	116	213TTDW4008	E172		126	213TFC6080	GT1111	✓	61
184TFN6555	U868A	✓	65	184TTWD16002	N445A	✓	115	213TTDW4009	E170		126	213TFN4103	L411A	✓	49
184TFN16056	E202-P	✓	57	184TTWW4002	N657B	✓	107	213TTDW4010	E171		126	213TFN6550	U869A	✓	65
184TFS14101	L410A	✓	49	184TTWW4028	N658B	✓	107	213TTDW4011	U188		136	213TFN16326	E203-P	✓	57
184TFR4003	U611		48	184TTWW6001	N615B	✓	108	213TTDW4012	U190		136	213TFS4005	U671		49
184TFR4005	U614		48	184TTWW6003	N317A	✓	106	213TTDW4013	U191		136	213TFS4030	U631		49
184TFR4013	U738		54	184TTWW6004	N315A	✓	106	213TTDW4014	U193		136	213TFS6501	E396		68
184TFR4021	U323		131	184TTWW6026	N616B	✓	108	213TTDW4022	E111	✓	126	213TFS6526	E618	✓	68
184TFR4038	U616	✓	48	184TTWW6027	N316B	✓	106	213TTDW4023	E173	✓	126	213TFS6530	E671	✓	68
184TFS4005	U615		49	184TTWW14004	N210	✓	109	213TTDW4025	U192		136	213TFS6531	E476	✓	68
184TFS4030	U620		49	184TTWW14005	N208	✓	109	213TTDW4030	E758		38	213TFS6576	E634	✓	68
184TFS6501	E602	✓	68	184TTWW14031	N209	✓	109	213TTDW4033	E167		126	213TFS6594	E471	✓	68
184TFS6505	E655	✓	68	184TTWW16002	N635	✓	108	213TTDW4038	E169		126	213TFS7238	Y381		188
184TFS6526	E617	✓	68	200LFC6511	R345A	✓	95	213TTDW4039	U184		136	213TFW4003	U622		48
184TFS6530	E670	✓	68	200LFC6513	R348A	✓	95	213TTDW4041	E166		126	213TFW4005	U625		48
184TFS6576	E388		68	200LFC6538	R346A	✓	95	213TTDW4042	E165		126	213TFW4007	U740		55
184TFS6810	E472	✓	68	200LFC6588	R341A	✓	95	213TTDW4044	U182		136	213TFW4008	U742		55
184TFS6844	E473	✓	68	200LFC6589	R344A	✓	95	213TTDW4047	E110	✓	126	213TFW4009	U327		131
184TFS7290	Y380		188	213TBFW7001	I224	✓	30	213TTDW4048	E168	✓	126	213TFW4010	U331		131
184TFW4009	U322A	✓	131	213TBFW7010	Z434	✓	124	213TTDW4049	U183	✓	136	213TFW4011	U328		137
184TFW4040	U1619		48	213TBFW7026	I216	✓	30	213TTDW4051	U185		136	213TFW4012	U332		137
184TFW4727	U616A	✓	48	213TBFW7027	Z117	✓	100	213TTDW4052	U187		136	213TFW4022	U329	✓	131
184TFW4760	U325A	✓	131	213TCDW7001	I105	✓	22,188	213TTDW4070	U429		38	213TFW4028	U627	✓	48
184TFW4914	U372	✓	137	213TCDW7002	Z410	✓	124	213TTDW4071	U926		38	213TFW4030	U630		48
184TFW4915	U360	✓	131	213TCDW7003	Z429	✓	132	213TTDW4078	U907	✓	38	213TFW4038	U335		131
184TFW6001	E2012	✓	60	213TCDW7026	I117		22	213TTDW7053	H955		195	213TFW4047	U334	✓	131
184TFW6026	E2013	✓	60	213TCDW7027	Z409	✓	124	213TTDW7201	Y489	✓	189	213TFW4345	C391		55
184TFW6076	E2008	✓	60	213TCDW7028	Z428		132	213TTDW7202	Y488		189	213TFW6001	E2015	✓	60
184TFW7727	H1668	✓	48	213TCDW7076	I143		22	213TTDW14013	U189A	✓	136	213TFW6076	E2011	✓	60
184TFW8641	C1224	✓	52	213THES8053	Y981	✓	89	213TTDW14014	C106A	✓	40	213TFW14010	M881A		157

Index

Model Number/Catalog Number

MODEL NO.	CAT. NO.	STOCK	PAGE NO.	MODEL NO.	CAT. NO.	STOCK	PAGE NO.	MODEL NO.	CAT. NO.	STOCK	PAGE NO.	MODEL NO.	CAT. NO.	STOCK	PAGE NO.
213TTFW14011	C205A	✓	52	215THFS9026	W539	✓	72	215TTDW7301	Y304	✓	103	215TTFW4036	U341		131
213TTFW14045	C225A	✓	52	215THFS9076	W527	✓	72	215TTDW7376	Y201		192	215TTFW4047	U340	✓	131
213TTFW14080	M877A		157	215THFS9101	W522		72	215TTDW7377	Y202	✓	192	215TTFW4345	C394		55
213TTFW14081	C253A		52	215THFS19006	W538		72	215TTDW14018	M813A		153	215TTFW6001	E2018	✓	60
213TTFW16001	E2115	✓	57	215THFS19033	W540	✓	72	215TTDW14020	U201A	✓	136	215TTFW6026	E2019	✓	60
213TTFW16008	C389A	✓	55	215THFS19077	W528		72	215TTDW14071	C126A		40	215TTFW6076	E2014	✓	60
213TTFW16020	E2140		57	215THFW7726	Y996	✓	85	215TTDW14073	U198A		136	215TTFW14021	M884A		157
213TTFW16026	E2116	✓	57	215THFW7736	Y997		85	215TTDW14087	M805A		153	215TTFW14022	C237A	✓	52
213TTFW16035	C390A	✓	55	215THTL7726	Y547	✓	86	215TTDW14110	H185A		38	215TTFW14024	C206A	✓	52
213TTFW16036	C391A	✓	55	215THTL7736	Y561	✓	86	215TTDW16061	U433A		41	215TTFW14040	M885A		157
213TTFW16039	E2016A	✓	60	215THTL7776	Y544	✓	86	215TTDW16073	U431A-P	✓	43	215TTFW14041	C226A	✓	52
213TTFW16040	E2141	✓	57	215THTS8038	Y566	✓	88	215TTDW17206	Y490		189	215TTFW14083	M880A		157
213TTFW16076	E2111	✓	57	215THTS8071	Y991	✓	90	215TTFB6006	GT3118	✓	133	215TTFW14084	C254A		52
213TTFW16078	C384A	✓	54	215TPFA10097	SY009	✓	91	215TTFB6008	GT3218	✓	133	215TTFW14301	U357	✓	131
213TTFW16081	E2136		57	215TTDB6001	GT0021	✓	45	215TTFB6012	GT3418	✓	142	215TTFW14302	U366		137
213TTFW16082	E2161		57	215TTDB6007	GT0421	✓	129	215TTFB6013	GT3518	✓	142	215TTFW16001	E2118	✓	58
213TTGN4067	C325A	✓	77	215TTDB6008	GT0521	✓	129	215TTFB6031	GT3119	✓	133	215TTFW16005	C392A	✓	55
213TTGN6501	U062A	✓	80	215TTDB6012	GT2421	✓	139	215TTFB6033	GT3219	✓	133	215TTFW16020	E2143		58
213TTGN6526	U006A	✓	80	215TTDB6013	GT2521	✓	139	215TTFB6037	GT3419	✓	142	215TTFW16026	E2119	✓	58
213TTGN6528	C366A	✓	75	215TTDB6026	GT0019	✓	45	215TTFB6038	GT3519	✓	142	215TTFW16040	E2144	✓	58
213TTGN6536	C370A	✓	75	215TTDB6032	GT0419	✓	129	215TTFB6082	GT3114	✓	133	215TTFW16041	C393A	✓	55
213TTGN6540	U991A	✓	80	215TTDB6033	GT0519	✓	129	215TTFB6085	GT3414	✓	141	215TTFW16042	C394A		55
213TTGN6576	U042A	✓	79	215TTDB6037	GT2419	✓	139	215TTFB6092	GT3214	✓	133	215TTFW16047	E2019A	✓	60
213TTGN16537	U025A	✓	80	215TTDB6038	GT2519	✓	139	215TTFB6095	GT3514	✓	141	215TTFW16076	E2114	✓	57
213TTGN16548	U991A-P	✓	80	215TTDB6076	GT0014	✓	45	215TTFBA6003	GT1218	✓	64	215TTFW16079	C388A	✓	54
213TTGS4030	U025		78	215TTDB6082	GT0414	✓	129	215TTFBA6004	GT1318	✓	63	215TTFW16080	E2139		57
213TTGS14015	C305	✓	77	215TTDB6085	GT2414	✓	139	215TTFBA6007	GT1418	✓	64	215TTFW16081	E2164		57
213TTLL7034	C407	✓	98	215TTDB6092	GT0514	✓	129	215TTFBA6028	GT1219	✓	64	215TTGN4065	C326A	✓	77
213TTTS6001	E218	✓	57	215TTDB6095	GT2514	✓	139	215TTFBA6029	GT1319	✓	63	215TTGN6501	U063A	✓	80
213TTTS6501	E603	✓	68	215TTDC6001	U766	✓	43	215TTFBA6032	GT1419	✓	64	215TTGN6526	U007A	✓	80
213TTTS6502	E475	✓	68	215TTDC6003	U286	✓	43	215TTFBA6078	GT1214	✓	64	215TTGN6528	C367A	✓	75
213TTTS6505	E656	✓	68	215TTDC6026	U765	✓	43	215TTFBA6079	GT1314	✓	63	215TTGN6539	U992A	✓	80
213TTTS17077	S507		191	215TTDC6029	U284	✓	43	215TTFC6001	GT1018	✓	61	215TTGN6576	U043A	✓	79
213TTTS17078	S557		191	215TTDC6076	U289	✓	43	215TTFC6002	U636A	✓	58	215TTGN16532	U026A	✓	80
213TTWD6031	N408A	✓	115	215TTDC6079	U280	✓	43	215TTFC6005	GT1118	✓	61	215TTGN16534	C371A		75
213TTWD14002	N160	✓	116	215TTDW4003	E788	✓	38	215TTFC6026	GT1019	✓	61	215TTGN16539	U992A-P	✓	80
213TTWD14032	N161	✓	116	215TTDW4007	E184		127	215TTFC6027	U639A	✓	58	215TTGS4030	U026		78
213TTWD16002	N446A	✓	115	215TTDW4008	E180		126	215TTFC6030	GT1119	✓	61	215TTGS14020	C306	✓	77
213TTWR4001	N659A	✓	107	215TTDW4009	E181		127	215TTFC6031	U641A	✓	58	215TTLL7050	C408	✓	98
213TTWR6002	N617A	✓	108	215TTDW4010	E182		126	215TTFC6076	GT1014	✓	61	215TTTS17077	S510	✓	191
213TTWR6026	N618A	✓	108	215TTDW4011	U200		136	215TTFC6077	U621A	✓	57	215TTTS17078	S560	✓	191
213TTWR6027	N318A	✓	106	215TTDW4012	U202		136	215TTFC6080	GT1114	✓	61	215TTWD6031	N409A	✓	115
213TTWR7026	N660	✓	107	215TTDW4013	U203		136	215TTFN6546	U870A	✓	65	215TTWD14002	N162	✓	116
213TTWW14031	N211	✓	109	215TTDW4014	U205		136	215TTFN16057	E204-P	✓	58	215TTWD14032	N163	✓	116
215TBD7361	Z125		160	215TTDW4022	E113	✓	127	215TTFSA4005	U637		49	215TTWD16002	N447A	✓	115
215TBDW7013	Z315		103	215TTDW4023	E183	✓	127	215TTFSA4030	U641		49	215TTWR6026	N619A	✓	108
215TBDW7026	I115	✓	22,188	215TTDW4025	U204		136	215TTFSA6030	E306		58	215TTWR6027	N319A	✓	106
215TBDW7027	Z413	✓	124	215TTDW4028	E907	✓	38	215TTFSA6501	E604	✓	68	215TTWR7026	N661	✓	107
215TBDW7028	I116	✓	22,188	215TTDW4030	E759	✓	38	215TTFSA6505	E657		68	215TTWW14007	N214	✓	109
215TBDW7029	Z411	✓	124	215TTDW4032	E179		126	215TTFSA6526	E619	✓	68	215TTWW14008	N664	✓	107
215TBDW7030	Z432		132	215TTDW4041	E175		126	215TTFSA6527	E479	✓	68	215TTWW14009	N212	✓	109
215TBDW7045	Z430		132	215TTDW4042	E176		126	215TTFSA6530	E672	✓	68	215TTWW14031	N213	✓	109
215TBDW7079	I144		22	215TTDW4043	E177		126	215TTFSA6576	E635	✓	68	215TTWW16002	N663	✓	107
215TBDW7362	Z126		160	215TTDW4044	U194		136	215TTFSA6580	E683		68	215TTWW16003	N637	✓	108
215TBFW7001	I225	✓	30	215TTDW4047	E112	✓	126	215TTFSA6807	E478	✓	68	225MTFC6501	R500	✓	95
215TBFW7010	Z435	✓	124	215TTDW4048	E178	✓	126	215TTFSA6881	E474	✓	68	225MTFC6526	R501	✓	95
215TBFW7026	I215	✓	30	215TTDW4049	U195	✓	136	215TTFSA7290	Y382	✓	188	225MTFC6586	R347A	✓	95
215TBFW7027	I217	✓	30	215TTDW4051	U196		136	215TTFSA14103	L421A	✓	49	225MTFC6526	R349A	✓	95
215TBFW7028	Z115	✓	100	215TTDW4052	U199		136	215TTFW4003	U634		48	250MTFC6501	R503	✓	95
215TBFW7029	Z122	✓	99	215TTDW4053	U197		136	215TTFW4005	E821		48	250MTFC6526	R504	✓	95
215TBFW7044	Z116	✓	100	215TTDW4071	M810A		153	215TTFW4013	U743		55	250MTFC6586	R350A	✓	95
215TCDW7002	Z412	✓	124	215TTDW4078	E935	✓	38	215TTFW4014	U336		131	254THEN8058	Y982	✓	89
215TCDW7003	Z308	✓	103	215TTDW4315	U435		41	215TTFW4015	U338		131	254THEN8059	Y983	✓	89
215TCDW7004	Z431	✓	132	215TTDW7053	H956	✓	195	215TTFW4022	U337	✓	131	254THFNA8038	Y597	✓	88
215TCDW7012	Z314		103	215TTDW7201	Y491		189	215TTFW4028	E822	✓	48	254THFNA9001	W544	✓	72
215TCDW17002	I106	✓	22	215TTDW7203	Y415	✓	189	215TTFW4030	U640		48	254THFNA9026	W546	✓	72
215THFS8029	Y596	✓	88	215TTDW7204	Y455	✓	189	215TTFW4033	U718		55	254THFNA9030	W547		72
215THFS9001	W537	✓	72	215TTDW7205	Y469	✓	189	215TTFW4035	U339		131	254THFNA9076	W534	✓	72

Model Number/Catalog Number

MODEL NO.	CAT. NO.	STOCK	PAGE NO.	MODEL NO.	CAT. NO.	STOCK	PAGE NO.	MODEL NO.	CAT. NO.	STOCK	PAGE NO.	MODEL NO.	CAT. NO.	STOCK	PAGE NO.
254THFNA9101	W529		72	254TFFC6006	U638A	✓	58	254TFFNA14084	M883A		157	256TDX4032	E761		38
254THFNA19065	W546-P	✓	72	254TFFC6027	U647B	✓	58	254TFFNA14103	L412A	✓	49	256TDX4041	U100		127
254THL5726	Y549	✓	86	254TFFC6031	U648A	✓	58	254TFFNA14336	Y1609		146	256TDX4047	U101		127
254THL5736	Y562	✓	86	254TFFC6077	U633A	✓	57	254TFFNA16074	E205-P	✓	58	256TDX4059	U223		137
254THL5776	Y546	✓	86	254TFFC6081	E005	✓	57	254TFFNA16568	U871A	✓	65	256TDX4063	U219	✓	137
254THNA8058	Y509	✓	88	254TFFCA6001	GT1021	✓	61	254TFFNA16838	E620-P	✓	68	256TDX4064	U218		137
254THNA8071	Y992	✓	90	254TFFCA6003	GT1221	✓	64	254TFFPA4005	U638		49	256TDX4065	U221		137
254TFFSA10088	SY010	✓	91	254TFFCA6005	GT1121	✓	61	254TFFPA14014	Y1608		146	256TDX4075	E197	✓	127
254TTDC6001	U768	✓	43	254TFFCA6006	GT3121	✓	134	254TTGN4030	U027		78	256TDX4094	M811A		153
254TTDC6003	U289	✓	43	254TFFCA6007	GT1421	✓	64	254TTGN6507	E502	✓	80	256TDX4310	M821A		153
254TTDC6026	U767	✓	43	254TFFCA6008	GT3221	✓	134	254TTGN6531	E503	✓	80	256TDX4326	E198		127
254TTDC6029	U287	✓	43	254TFFCA6012	GT3421	✓	142	254TTGN6576	E500	✓	80	256TDX4328	U220		137
254TTDC6079	U282	✓	43	254TFFCA6013	GT3521	✓	142	254TTGN14042	C327A	✓	77	256TDX4329	E199		127
254TTDCA6001	GT0024	✓	45	254TFFCA6026	GT1022	✓	61	254TTGN16541	U027A	✓	80	256TDX7101	H187	✓	38
254TTDCA6007	GT0424	✓	129	254TFFCA6028	GT1222	✓	64	254TTGN16549	E503-P	✓	80	256TDX7207	Y492		189
254TTDCA6008	GT0524	✓	129	254TFFCA6030	GT1122	✓	61	254TTGP14013	C307A	✓	77	256TDX7253	Y471		189
254TTDCA6012	GT2424	✓	139	254TFFCA6031	GT3122	✓	134	254TTNA17077	S513	✓	191	256TDX7263	Y457		189
254TTDCA6013	GT2524	✓	139	254TFFCA6032	GT1422	✓	64	254TTNA18530	S518		191	256TDX7264	Y458	✓	189
254TTDCA6026	GT0022	✓	45	254TFFCA6033	GT3222	✓	134	256TBDX7028	Z127		160	256TDX7391	Y204	✓	192
254TTDCA6032	GT0422	✓	129	254TFFCA6037	GT3422	✓	142	256THBN17031	Y984	✓	89	256TDX14039	M818A		153
254TTDCA6033	GT0522	✓	129	254TFFCA6038	GT3522	✓	142	256THFNA8038	Y598	✓	88	256TDX14087	C156A		40
254TTDCA6037	GT2422	✓	139	254TFFCA6076	GT1017	✓	61	256THFNA9001	W551	✓	72	256TDX16032	E723B	✓	43
254TTDCA6038	GT2522	✓	139	254TFFCA6078	GT1217	✓	64	256THFNA9026	W553	✓	72	256TDX16033	E723B-P	✓	43
254TTDCA6076	GT0017	✓	45	254TFFCA6080	GT1117	✓	61	256THFNA9076	W541	✓	72	256TDX16078	E734A	✓	43
254TTDCA6082	GT0417	✓	129	254TFFCA6082	GT3117	✓	133	256THFNA9101	W536		72	256TDX6002	U649A	✓	58
254TTDCA6085	GT2417	✓	139	254TFFCA6085	GT3417	✓	141	256THFNA19033	W554	✓	72	256TFC6027	U652B	✓	58
254TTDCA6092	GT0517	✓	129	254TFFCA6092	GT3217	✓	133	256THFNA19056	W553-P	✓	72	256TFC6031	U653A	✓	58
254TTDCA6095	GT2517	✓	139	254TFFCA6095	GT3517	✓	141	256THFNA19081	W542		72	256TFC6077	U642A	✓	58
254TTDN16056	U436A	✓	41	254TFFL4006	U344	✓	131	256THL5776	Y548	✓	86	256TFC6081	E006	✓	58
254TTDX4006	E191	✓	127	254TFFL4009	U343		137	256HTNA7026	Y552	✓	87	256TFFCA6001	GT1024	✓	61
254TTDX4007	E190		127	254TFFL4010	U346		131	256HTNA7036	Y563	✓	87	256TFFCA6003	GT1224	✓	64
254TTDX4008	U214		137	254TFFL4011	U356		137	256HTNA8038	Y510	✓	88	256TFFCA6005	GT1124	✓	61
254TTDX4010	U215		137	254TFFL4027	U646A	✓	48	256HTNA8071	Y993	✓	90	256TFFCA6006	GT3124	✓	134
254TTDX4012	U216		137	254TFFL4031	U348	✓	131	256TFFSA10087	SY011	✓	91	256TFFCA6008	GT3224	✓	134
254TTDX4014	U212		137	254TFFL4033	U721		55	256TDC6003	U291	✓	43	256TFFCA6012	GT3424	✓	142
254TTDX4015	E193		127	254TFFL4034	U347		131	256TDC6026	U769	✓	43	256TFFCA6013	GT3524	✓	142
254TTDX4016	U217		137	254TFFL4035	U723		55	256TDC6029	U290	✓	43	256TFFCA6026	GT1025	✓	61
254TTDX4017	U213	✓	137	254TFFL4036	U349		131	256TDC6079	U285	✓	43	256TFFCA6028	GT1225	✓	64
254TTDX4018	U900		38	254TFFL14004	U643		48	256TDC6001	GT0027	✓	45	256TFFCA6030	GT1125	✓	61
254TTDX4019	E192		127	254TFFL14005	U645		48	256TDC6007	GT0427	✓	129	256TFFCA6031	GT3125	✓	134
254TTDX4020	E194		127	254TFFL14008	U345A	✓	137	256TDC6008	GT0527	✓	129	256TFFCA6033	GT3225	✓	134
254TTDX4024	E195		127	254TFFL14009	C207A		52	256TDC6012	GT2427	✓	139	256TFFCA6037	GT3425	✓	142
254TTDX4028	E908	✓	38	254TFFL14037	C227A	✓	52	256TDC6013	GT2527	✓	139	256TFFCA6038	GT3525	✓	142
254TTDX4030	E760	✓	38	254TFFL14078	C255A		52	256TDC6026	GT0025	✓	45	256TFFCA6076	GT1020	✓	61
254TTDX4039	E188	✓	127	254TFFL16001	E2121	✓	58	256TDC6032	GT0425	✓	129	256TFFCA6078	GT1220	✓	64
254TTDX4041	U210	✓	136	254TFFL16020	E2146		58	256TDC6033	GT0525	✓	129	256TFFCA6080	GT1120	✓	61
254TTDX4060	U209		136	254TFFL16026	E2122	✓	58	256TDC6037	GT2425	✓	139	256TFFCA6082	GT3120	✓	133
254TTDX4074	U206		136	254TFFL16036	E2122-P	✓	58	256TDC6038	GT2525	✓	139	256TFFCA6085	GT3420	✓	142
254TTDX4075	U207	✓	136	254TFFL16040	E2147	✓	58	256TDC6076	GT0020	✓	45	256TFFCA6092	GT3220	✓	133
254TTDX4315	U437		41	254TFFL16076	E2117	✓	57	256TDC6082	GT0420	✓	129	256TFFCA6095	GT3520	✓	142
254TTDX4340	U208		136	254TFFL16077	E2142		57	256TDC6085	GT2420	✓	139	256TFL4006	U351	✓	131
254TTDX4341	U211		136	254TFFNA4030	U648		49	256TDC6092	GT0520	✓	129	256TFL4010	U350		131
254TTDX4343	E185		127	254TFFNA6001	E220	✓	58	256TDC6095	GT2520	✓	139	256TFL4012	U352		131
254TTDX4344	E186		127	254TFFNA6026	E205	✓	58	256TDN14102	H187A	✓	38	256TFL4031	U354	✓	131
254TTDX4345	E187		127	254TFFNA6030	E307	✓	58	256TDN16009	U439A		41	256TFL4036	U353		131
254TTDX7201	Y470		189	254TFFNA6076	E235	✓	57	256TDN16011	M722		154	256TFL4038	U355		131
254TTDX7208	Y418	✓	189	254TFFNA6501	E605	✓	68	256TDN16049	U438A		41	256TFL14027	U651		48
254TTDX7278	Y456	✓	189	254TFFNA6503	E658		68	256TDN16053	M718		154	256TFL14030	E998		48
254TTDX7377	Y203		192	254TFFNA6515	E481	✓	68	256TDX4004	U225	✓	137	256TFL16002	E2123	✓	58
254TTDX8338	H957		195	254TFFNA6526	E620	✓	68	256TDX4006	U103	✓	127	256TFL16020	E2148		58
254TTDX14062	E114A	✓	127	254TFFNA6528	E673	✓	68	256TDX4013	E786	✓	38	256TFL16033	E2124	✓	58
254TTDX14064	M814A		153	254TFFNA6529	E482	✓	68	256TDX4019	U104		127	256TFL16038	E2124-P	✓	58
254TTDX14088	M808A		153	254TFFNA6576	E636	✓	68	256TDX4020	U501		144	256TFL16040	E2149	✓	58
254TTDX14089	C155A		40	254TFFNA6578	E684		68	256TDX4021	U102		127	256TFL16076	E2120	✓	58
254TTDX14104	H186A	✓	38	254TFFNA6590	E477	✓	68	256TDX4022	U224		137	256TFL16077	E2145		58
254TTDX16042	E722A	✓	43	254TFFNA7012	M888		157	256TDX4023	U226		137	256TFFNA4005	U650		50
254TTDX16043	E722A-P	✓	43	254TFFNA7210	Y383		188	256TDX4024	U500		144	256TFFNA4030	U653		50
254TTDX16082	E733A	✓	43	254TFFNA14072	M889		157	256TDX4027	E909	✓	38	256TFFNA6001	E221	✓	58

Index

Model Number/Catalog Number

MODEL NO.	CAT. NO.	STOCK	PAGE NO.	MODEL NO.	CAT. NO.	STOCK	PAGE NO.	MODEL NO.	CAT. NO.	STOCK	PAGE NO.	MODEL NO.	CAT. NO.	STOCK	PAGE NO.
256TFNA6026	E206	✓	58	284TSTFPA14007	Y1612		146	284TTFNA6076	E237	✓	58	286TTDCA6032	GT0431	✓	130
256TFNA6030	E308	✓	58	284TSTGN6503	E546	✓	80	284TTFNA6526	E622	✓	69	286TTDCA6033	GT0531	✓	130
256TFNA6076	E236	✓	58	284TSTGN16531	U076A		80	284TTFNA6527	E675	✓	69	286TTDCA6037	GT2431	✓	140
256TFNA6501	E606	✓	69	284TTDC6026	U771	✓	43	284TTFNA6576	E638	✓	68	286TTDCA6038	GT2531	✓	140
256TFNA6503	E659	✓	69	284TTDC6029	E762A	✓	43	284TTFNA6580	E694	✓	68	286TTDCA6076	GT0026	✓	45
256TFNA6523	E484	✓	69	284TTDC6076	U256	✓	43	284TTFNA6837	E488	✓	69	286TTDCA6082	GT0426	✓	129
256TFNA6526	E621	✓	69	284TTDC6079	U288	✓	43	284TTFNA6876	E483	✓	68	286TTDCA6085	GT2426	✓	139
256TFNA6528	E674	✓	69	284TTDCA6007	GT0430	✓	130	284TTFNA7240	Y385	✓	188	286TTDCA6092	GT0526	✓	129
256TFNA6529	E485	✓	69	284TTDCA6008	GT0530	✓	130	284TTFNA7508	M896		157	286TTDCA6095	GT2526	✓	139
256TFNA6576	E637	✓	68	284TTDCA6012	GT2430	✓	140	284TTFNA14102	L414A	✓	49	286TTDN14101	H189A		38
256TFNA6578	E685		68	284TTDCA6013	GT2530	✓	140	284TTFNA16070	E207-P	✓	58	286TTDP4015	U114	✓	127
256TFNA6596	E480	✓	68	284TTDCA6026	GT0028	✓	45	284TTFNA16832	U873A	✓	65	286TTDP4020	U236	✓	137
256TFNA7028	M893		157	284TTDCA6032	GT0428	✓	129	284TTFNA16851	E622-P	✓	69	286TTDP4021	U115		127
256TFNA7250	Y384	✓	188	284TTDCA6033	GT0528	✓	129	284TTFPA4028	U655	✓	50	286TTDP4024	U237		137
256TFNA14016	M892A		157	284TTDCA6037	GT2428	✓	139	284TTFPA4030	E800		50	286TTDP4027	E911	✓	39
256TFNA14022	Y1610		146	284TTDCA6038	GT2528	✓	139	284TTFPA14048	M897A		157	286TTDP4034	E763		39
256TFNA14071	Y1611		146	284TTDCA6076	GT0023	✓	45	284TTFPA14049	M890A		157	286TTDP4037	U112		127
256TFNA14084	M886A		157	284TTDCA6082	GT0423	✓	129	284TTFPA14055	Y1613		146	286TTDP4041	U506		144
256TFNA14086	C256A		52	284TTDCA6085	GT2423	✓	139	284TTGN6533	E547	✓	80	286TTDP4047	U113		127
256TFNA14101	L413A	✓	49	284TTDCA6092	GT0523	✓	129	284TTGN6576	E504	✓	80	286TTDP4048	U233		137
256TFNA16070	E206-P	✓	58	284TTDCA6095	GT2523	✓	139	284TTGN16539	U029A	✓	80	286TTDP4049	U235		137
256TFNA16574	U872A	✓	65	284TTDN14102	H188A		38	284TTGN16550	E547-P	✓	80	286TTDP4067	U111		127
256TFNA16855	E621-P	✓	69	284TTDP4011	U230		137	284TTGP4030	U029		78	286TTDP4074	U234	✓	137
256TTGN4030	U028		78	284TTDP4012	U232		137	284TTTNA16577	S519		191	286TTDP7217	Y460	✓	189
256TTGN6531	E506	✓	80	284TTDP4022	U231	✓	137	284TTTNA17101	S567	✓	191	286TTDP7251	Y473		189
256TTGN6576	E501	✓	80	284TTDP4023	U110		127	284TTTNA18577	S569		191	286TTDP7689	Y216	✓	192
256TTGN14011	C308A		77	284TTDP4025	U108		127	284TTTNA18601	S517		191	286TTDR14042	U507		144
256TTGN14044	C328A	✓	77	284TTDP4027	U502		144	286THFNA8028	Y570	✓	88	286TTDR14042	M826A		153
256TTGN16509	E505	✓	80	284TTDP4029	E910	✓	38	286THFNA9026	W567	✓	72	286TTDR14046	M822A		153
256TTGN16540	U028A	✓	80	284TTDP4035	E762		38	286THFNA9076	W555	✓	72	286TTDR14081	M819A		153
256TTGN16552	E506-P	✓	80	284TTDP4037	U107		127	286THFNA19033	W568		72	286TTDR16037	E1009	✓	43
256TTTNA18577	S566		191	284TTDP4043	U105		127	286THFNA19066	W567-P	✓	72	286TTDR16038	E1009-P	✓	43
256TTTNA18578	S516	✓	191	284TTDP4044	U227		137	286THFNA19077	W556		72	286TTDR17009	M829		153
256TTTNA18601	S564		191	284TTDP4045	U229		137	286THFNA19101	W550	✓	72	286TTFC6027	E983B	✓	58
280MFC6588	R505	✓	95	284TTDP4047	U503		144	286THFNA8038	Y512	✓	88	286TTFC6031	E817A	✓	59
280STFC6501	R506	✓	95	284TTDP4069	U106	✓	127	286THFPA8086	Y582		88	286TTFC6081	E008	✓	58
280STFC6526	R507	✓	95	284TTDP7202	Y493		189	286THTNA7026	Y393	✓	87	286TTFC6006	GT3130	✓	134
280STFC6586	R502	✓	95	284TTDP7205	Y472		189	286THTNA7036	Y394		87	286TTFC6008	GT3230	✓	134
284THEN8032	Y985	✓	89	284TTDP7221	Y459	✓	189	286TPFSA10090	SV013	✓	91	286TTFC6012	GT3430	✓	142
284THFNA9026	W560	✓	72	284TTDP7692	Y215	✓	192	286TSHFNA9001	W565	✓	72	286TTFC6013	GT3530	✓	142
284THFNA9076	W548	✓	72	284TTDP14009	U109A	✓	127	286TSTDC6003	U293	✓	44	286TTFC6026	GT1031	✓	62
284THFNA19048	W560-P	✓	72	284TTDP14044	U228A	✓	137	286TSTDC6001	GT0033	✓	45	286TTFC6028	GT1231	✓	64
284THFNA19084	W549		72	284TTDR14011	M825A		153	286TSTDN16004	U443A	✓	41	286TTFC6030	GT1131	✓	62
284THFNA19033	W561	✓	72	284TTDR14082	M815A		153	286TSTDN16005	U441A	✓	41	286TTFC6032	GT3131	✓	134
284THFNA19102	W543		72	284TTDR16047	E1006	✓	43	286TSTDN16033	U442A		41	286TTFC6033	GT3231	✓	134
284THFPA8028	Y569	✓	88	284TTDR16048	E1006-P	✓	43	286TSTDN16034	U440A		41	286TTFC6037	GT3431	✓	142
284THFPA8038	Y511	✓	88	284TTDR16077	E1002	✓	43	286TSTDP4017	U902		39	286TTFC6038	GT3531	✓	142
284THFPA8086	Y395		88	284TTFC6031	E800A	✓	58	286TSTDP4022	U508	✓	144	286TTFC6076	GT1026	✓	61
284THTNA7026	Y553	✓	87	284TTFC6077	E978A	✓	58	286TSTDP4023	U509	✓	144	286TTFC6080	GT1126	✓	61
284THTNA7036	Y567		87	284TTFCA6006	GT3127	✓	134	286TSTDR16002	E1010	✓	44	286TTFC6082	GT3126	✓	134
284TPFSA10112	SY012	✓	91	284TTFCA6008	GT3227	✓	134	286TSTFC6036	E818A	✓	58	286TTFC6085	GT3426	✓	142
284TSHFNA9001	W558	✓	72	284TTFCA6012	GT3427	✓	142	286TSTFCA6001	GT1030	✓	62	286TTFC6092	GT3226	✓	134
284TSHFNA9005	W559		72	284TTFCA6013	GT3527	✓	142	286TSTFCA6003	GT1230	✓	64	286TTFC6095	GT3526	✓	142
284TSTDC6003	U292	✓	43	284TTFCA6026	GT1028	✓	62	286TSTFCA6005	GT1130	✓	62	286TTFNA6026	E208	✓	58
284TSTDC6001	GT0030	✓	45	284TTFCA6028	GT1128	✓	64	286TSTFNA6001	E223	✓	58	286TTFNA6030	E310	✓	58
284TSTDN16031	E793A		43	284TTFCA6030	GT1128	✓	62	286TSTFNA6501	E608	✓	69	286TTFNA6076	E238	✓	58
284TSTDP4002	U504	✓	144	284TTFCA6032	GT3128	✓	134	286TSTFNA6804	E490	✓	69	286TTFNA6526	E623	✓	69
284TSTDP4004	U901		39	284TTFCA6033	GT3228	✓	134	286TSTFPA4005	E819		50	286TTFNA6527	E676	✓	69
284TSTDP14007	U505		144	284TTFCA6037	GT3428	✓	142	286TSTFPA14006	Y1614		146	286TTFNA6570	E491	✓	69
284TSTDR16003	E1008	✓	43	284TTFCA6038	GT3528	✓	142	286TSTGN6501	E563	✓	80	286TTFNA6576	E639	✓	69
284TSTFC6036	E999A	✓	58	284TTFCA6076	GT1023	✓	61	286TSTGN16531	U077A		80	286TTFNA6580	E695		69
284TSTFCA6001	GT1027	✓	62	284TTFCA6080	GT1123	✓	61	286TTDC6026	U773	✓	43	286TTFNA6876	E486		69
284TSTFCA6003	GT1227	✓	64	284TTFCA6082	GT3123	✓	134	286TTDC6029	E763A	✓	43	286TTFNA7260	Y386	✓	188
284TSTFCA6005	GT1127	✓	62	284TTFCA6085	GT3423	✓	142	286TTDCA6007	GT0433	✓	130	286TTFNA14050	Y1615		146
284TSTFNA6001	E222	✓	58	284TTFCA6092	GT3223	✓	134	286TTDCA6008	GT0533	✓	130	286TTFNA14085	M894A		157
284TSTFNA6501	E607	✓	69	284TTFCA6095	GT3523	✓	142	286TTDCA6012	GT2433	✓	140	286TTFNA14106	L415A	✓	49
284TSTFNA6502	E660		69	284TTFNA6026	E207	✓	58	286TTDCA6013	GT2533	✓	140	286TTFNA16328	E208-P	✓	58
284TSTFPA4005	U654		50	284TTFNA6030	E309	✓	58	286TTDCA6026	GT0031	✓	45	286TTFNA16572	U874A	✓	65

Model Number/Catalog Number

MODEL NO.	CAT. NO.	STOCK	PAGE NO.	MODEL NO.	CAT. NO.	STOCK	PAGE NO.	MODEL NO.	CAT. NO.	STOCK	PAGE NO.	MODEL NO.	CAT. NO.	STOCK	PAGE NO.
286TTFNA16847	E623-P	✓	69	324TTDR14049	M830A	✓	153	326TSTFCA6003	GT1236	✓	64	326TTFS16073	E210-P	✓	59
286TTFPA4030	E817	✓	50	324TTDR14080	M823A	✓	153	326TSTFCA6005	GT1136	✓	62	326TTFS16574	U875A	✓	65
286TTFPA14011	M900A	✓	157	324TTDR14104	M820A	✓	153	326TSTFPA14013	Y1619	✓	146	326TTFS16844	E625-P	✓	69
286TTFPA14063	M901A	✓	157	324TTDR16050	U775-P	✓	44	326TSTFS6001	E225	✓	59	326TTGP4030	U032	✓	78
286TTGN6537	E564	✓	80	324TTFCA6007	GT3133	✓	134	326TSTFS6005	E320	✓	59	326TTGS6532	E570	✓	80
286TTGN16533	U030A	✓	80	324TTFCA6008	GT3233	✓	134	326TSTFS6501	E610	✓	69	326TTGS6578	E565	✓	80
286TTGN16546	E564-P	✓	80	324TTFCA6012	GT3433	✓	142	326TSTFS6502	E663	✓	69	326TTGS16539	U032A	✓	80
286TTGN16577	E507	✓	80	324TTFCA6013	GT3533	✓	142	326TSTFS6536	E453	✓	69	326TTGS16546	E570-P	✓	80
286TTGP4030	U030	✓	78	324TTFCA6026	GT1034	✓	62	326TSTGS6501	E569	✓	80	326TTTS18577	S528	✓	191
286TTTNA18577	S522	✓	191	324TTFCA6028	GT1234	✓	64	326TSTGS16532	U079A	✓	80	364THFS8036	Y573	✓	88
315STFC6588	R508	✓	95	324TTFCA6030	GT1134	✓	62	326TTDC6026	U777	✓	44	364THFS8046	Y515	✓	88
324THFA8028	Y571	✓	88	324TTFCA6031	GT3134	✓	134	326TTDC6029	E765A	✓	44	364THFS8391	Y585	✓	88
324THFA8038	Y513	✓	88	324TTFCA6033	GT3234	✓	134	326TTDCA6026	GT0037	✓	45	364THFS9036	W587	✓	73
324THFA8086	Y583	✓	88	324TTFCA6037	GT3434	✓	142	326TTDCA6032	GT0437	✓	130	364THFS19033	W588	✓	73
324THFS9026	W573	✓	73	324TTFCA6038	GT3534	✓	142	326TTDCA6033	GT0537	✓	130	364THFS19061	W587-P	✓	73
324THFS9076	W562	✓	72	324TTFCA6076	GT1029	✓	62	326TTDCA6037	GT2437	✓	140	364THFS19077	W639	✓	73
324THFS9080	W563	✓	72	324TTFCA6080	GT1129	✓	62	326TTDCA6038	GT2537	✓	140	364THFS19087	W575A	✓	73
324THFS19033	W574	✓	73	324TTFCA6082	GT3129	✓	134	326TTDCA6076	GT0032	✓	45	364THFS9001	W584	✓	73
324THFS19058	W573-P	✓	73	324TTFCA6085	GT3429	✓	142	326TTDCA6082	GT0432	✓	130	364THFS9026	W586	✓	73
324THFS9001	W571	✓	73	324TTFCA6092	GT3229	✓	134	326TTDCA6085	GT2432	✓	140	364TSTDCB6001	GT0042	✓	46
324TSTDC6003	U294	✓	44	324TTFCA6095	GT3529	✓	142	326TTDCA6092	GT0532	✓	130	364TSTDS4024	U523	✓	145
324TSTDC6001	GT0036	✓	45	324TTFPA4030	E815	✓	50	326TTDCA6095	GT2532	✓	140	364TSTDS4025	U522	✓	145
324TSTDP4006	U909	✓	38	324TTFPA14065	M905A	✓	157	326TTDP4032	U243	✓	137	364TSTDS4332	U518	✓	144
324TSTDP4007	U513	✓	144	324TTFPA14071	Y1618	✓	146	326TTDP4046	E790	✓	39	364TSTDS4337	U519	✓	144
324TSTDP4010	U512	✓	144	324TTFPA14089	M898A	✓	157	326TTDP4048	E765	✓	39	364TSTFC6006	E015	✓	59
324TSTDP16002	U445A	✓	41	324TTFCA6026	E209	✓	59	326TTDP4326	U121	✓	127	364TSTFC6026	E802A	✓	59
324TSTDP16032	U444A	✓	41	324TTFCA6030	E311	✓	59	326TTDP4329	U120	✓	127	364TSTFCA6001	GT1039	✓	62
324TSTFC6006	E011	✓	59	324TTFCA6076	E239	✓	58	326TTDP4340	U242	✓	137	364TSTFCA6003	GT1239	✓	64
324TSTFC6036	E816A	✓	59	324TTFCA6526	E624	✓	69	326TTDP4344	U515	✓	144	364TSTFCA6005	GT1139	✓	62
324TSTFCA6001	GT1033	✓	62	324TTFCA6527	E677	✓	69	326TTDP4345	U514	✓	144	364TSTFS6001	E226	✓	59
324TSTFCA6003	GT1233	✓	64	324TTFCA6576	E640	✓	69	326TTDP7697	Y218	✓	192	364TSTFS6005	E321	✓	59
324TSTFCA6005	GT1133	✓	62	324TTFCA6577	E696	✓	69	326TTDR14010	M837A	✓	154	364TSTFS6501	E611	✓	69
324TSTFPA14010	Y1616	✓	146	324TTFCA7290	Y387	✓	188	326TTDR14034	M834A	✓	153	364TSTFS6505	E664	✓	69
324TSTFS6001	E224	✓	59	324TTFCA14003	M904A	✓	157	326TTDR14103	M824A	✓	153	364TSTFS6526	E454	✓	69
324TSTFS6005	E319	✓	59	324TTFCA14101	L416A	✓	50	326TTDR14105	H191A	✓	38	364TSTFS14009	Y1622	✓	146
324TSTFS6501	E609	✓	69	324TTFCA16066	E209-P	✓	59	326TTDR16063	E791A-P	✓	44	364TSTGS6506	E572	✓	80
324TSTFS6505	E662	✓	69	324TTFCA16837	U875A	✓	65	326TTFCA6031	U659A	✓	59	364TSTGS16531	U080A	✓	80
324TSTGS6501	E566	✓	80	324TTFCA16860	E624-P	✓	69	326TTFCA6007	GT3136	✓	134	364TTDCA6060	U1779	✓	44
324TSTGS16531	U078A	✓	80	324TTGP4030	U031	✓	78	326TTFCA6008	GT3236	✓	134	364TTDCA6086	U1927	✓	44
324TTDC6029	E764A	✓	44	324TTGS6529	E567	✓	80	326TTFCA6012	GT3436	✓	142	364TTDCB6060	GT0040	✓	45
324TTDC6076	U798	✓	43	324TTGS16535	U031A	✓	80	326TTFCA6013	GT3536	✓	142	364TTDCB6086	GT0035	✓	45
324TTDCA6007	GT0436	✓	130	324TTGS16541	E567-P	✓	80	326TTFCA6026	GT1037	✓	62	364TTDR14032	M838A	✓	154
324TTDCA6008	GT0536	✓	130	324TTGS16577	U048A	✓	80	326TTFCA6028	GT1237	✓	64	364TTDS4040	E766	✓	39
324TTDCA6012	GT2436	✓	140	324TTTS18577	S525	✓	191	326TTFCA6030	GT1137	✓	62	364TTDS4328	U520	✓	144
324TTDCA6013	GT2536	✓	140	324TTTS18601	S523	✓	191	326TTFCA6031	GT3137	✓	134	364TTDS14011	M841A	✓	154
324TTDCA6026	GT0034	✓	45	326THFA8038	Y514	✓	88	326TTFCA6033	GT3237	✓	134	364TTDS14081	M831A	✓	153
324TTDCA6032	GT0434	✓	130	326THFA8086	Y584	✓	88	326TTFCA6037	GT3437	✓	142	364TTDS14104	M828A	✓	153
324TTDCA6033	GT0534	✓	130	326THFS8028	Y572	✓	88	326TTFCA6038	GT3537	✓	142	364TTDS14329	U538	✓	144
324TTDCA6037	GT2434	✓	140	326THFS9026	W580	✓	73	326TTFCA6076	GT1032	✓	62	364TTFCA6036	GT1040	✓	62
324TTDCA6038	GT2534	✓	140	326THFS9076	W569	✓	72	326TTFCA6080	GT1132	✓	62	364TTFCA6038	GT1240	✓	64
324TTDCA6076	GT0029	✓	45	326THFS19033	W581	✓	73	326TTFCA6082	GT3132	✓	134	364TTFCA6040	GT1140	✓	62
324TTDCA6082	GT0429	✓	129	326THFS19071	W580-P	✓	73	326TTFCA6085	GT3432	✓	142	364TTFCA6080	GT1135	✓	62
324TTDCA6085	GT2429	✓	139	326THFS19078	W643	✓	72	326TTFCA6092	GT3232	✓	134	364TTFCA6086	GT1035	✓	62
324TTDCA6092	GT0529	✓	129	326TSHFS9001	W577	✓	73	326TTFCA6095	GT3532	✓	142	364TTFS4040	U660	✓	50
324TTDCA6095	GT2529	✓	139	326TSHFS9005	W578	✓	73	326TTFPA4030	U659	✓	50	364TTFS6036	E211	✓	59
324TTDP4002	U240	✓	137	326TSHFS9036	W579	✓	73	326TTFPA14049	M909A	✓	157	364TTFS6040	E313	✓	59
324TTDP4004	U118	✓	127	326TSTDC6001	GT0039	✓	45	326TTFS6026	E210	✓	59	364TTFS6536	E626	✓	69
324TTDP4011	U241	✓	137	326TSTDP4003	U910	✓	39	326TTFS6030	E312	✓	59	364TTFS6537	E679	✓	69
324TTDP4018	U119	✓	127	326TSTDP4022	U517	✓	144	326TTFS6076	E240	✓	59	364TTFS8101	L420	✓	50
324TTDP4028	E764	✓	39	326TSTDP4024	U516	✓	144	326TTFS6526	E625	✓	69	364TTFS9234	Y389	✓	188
324TTDP4030	E787	✓	39	326TSTDP16005	U447A	✓	41	326TTFS6527	E678	✓	69	364TTFS14003	M912A	✓	158
324TTDP4033	U239	✓	137	326TSTDP16032	E789A	✓	44	326TTFS6576	E641	✓	69	364TTFS14058	M913A	✓	158
324TTDP4038	U510	✓	144	326TSTDR14034	U521	✓	144	326TTFS6580	E400	✓	69	364TTFS14064	Y1624	✓	146
324TTDP4345	U116	✓	127	326TSTDR16034	E791A	✓	44	326TTFS9210	Y388	✓	188	364TTFS14087	M906A	✓	157
324TTDP4348	U238	✓	137	326TSTDR16035	U446A	✓	41	326TTFS14101	L417A	✓	50	364TTFS16083	E241A	✓	59
324TTDP7687	Y217	✓	192	326TSTFC6006	E013	✓	59	326TTFS14103	M899A	✓	157	364TTFS16558	U877A	✓	65
324TTDP14049	U511	✓	144	326TSTFC6036	E801A	✓	59	326TTFS14046	Y1621	✓	146	364TTFS16584	E642A	✓	69
324TTDR14010	M833A	✓	153	326TSTFCA6001	GT1036	✓	62	326TTFS14087	M902A	✓	157	364TTFS16585	E401A	✓	69

Index

Model Number/Catalog Number

MODEL NO.	CAT. NO.	STOCK	PAGE NO.	MODEL NO.	CAT. NO.	STOCK	PAGE NO.	MODEL NO.	CAT. NO.	STOCK	PAGE NO.	MODEL NO.	CAT. NO.	STOCK	PAGE NO.
364TTGS4040	U033		78	365TTFS14060	M917A		158	405TSTFS6526	E456	✓	70	444TTDS14003	M857A		154
364TTGS16536	E573A	✓	80	365TTFS14071	Y1627		146	405TSTFS14007	Y1628		146	444TTDS14057	M854A		154
364TTGS16537	U033A	✓	80	365TTFS14084	M910A		157	405TSTFS16033	E808A	✓	59	444TTDS14086	M847A		154
364TTGS16577	E568A	✓	80	365TTFS16083	E242A	✓	59	405TSTGS6503	E578		81	444TTDS14101	M844A		154
365THFS8036	Y574	✓	88	365TTFS16591	E643A	✓	69	405TSTGS16531	U082A		81	444TTDS16043	U911A		44
365THFS8046	Y516	✓	88	365TTFS16592	E402A		69	405TSDC6060	GT0049	✓	46	444TTDS16077	U272	✓	44
365THFS8380	Y586		88	365TTFS16827	U878A	✓	65	405TSDC16081	GT0044	✓	46	444TTDS4069	U911		39
365THFS9036	W594	✓	73	365TTFS17102	M907		157	405TSDS4049	U904		39	444TTDS6060	E924	✓	44
365THFS9044	W595	✓	73	365TTGS4040	U034		78	405TSDS4376	M843A		154	444TTDS8699	Y212	✓	192
365THFS19065	W594-P	✓	73	365TTGS16540	E576A	✓	81	405TDS6060	E923	✓	44	444TTF6036	GT1049	✓	62
365THFS19077	W640		73	365TTGS16542	U034A	✓	81	405TDS7124	M840		154	444TTF6044	GT1149	✓	62
365THFS19086	W582A	✓	73	365TTGS16577	E571	✓	80	405TDS7697	Y211		192	444TTF6080	GT1147	✓	62
365THFS19101	W576		73	404THFS8092	Y587		88	405TDS14003	M853A		154	444TTF6086	GT1047	✓	62
365THFS9001	W591	✓	73	404THFS9086	W589		73	405TDS14067	M850A		154	444TTFN6044	E316A		60
365THFS19002	W592		73	404THFS9101	W583		73	405TDS16060	U904A		44	444TTFN6086	E328	✓	59
365THFS19034	W593A		73	404TSDC6001	GT0048	✓	46	405TDS16070	M750		154	444TTFN14044	M925A		158
365TSDCB6001	GT0045	✓	46	404TSDS4017	U530	✓	145	405TDS16081	U271	✓	44	444TTFN14080	M922A		158
365TSDS4025	U526	✓	145	404TSDS4332	U528	✓	145	405TFC6036	GT1046	✓	62	444TTFN16549	U880A	✓	65
365TSDS4303	U527	✓	145	404TSDS4333	U529	✓	145	405TFC6038	GT1246	✓	64	444TTFN16581	E464A	✓	70
365TSDS4332	U524	✓	145	404TSDS6001	U250	✓	44	405TFC6040	GT1146	✓	62	444TTFN16582	E405A		70
365TSDS4347	U525		145	404TSDS6327	U452A		41	405TFC6080	GT1144	✓	62	444TTFN16577	E327		70
365TSDS6074	U450A		41	404TSDS14008	U531	✓	145	405TFC6086	GT1044	✓	62	444TTF6036	E214	✓	60
365TSDS16005	U451A		41	404TSDS16006	U453A	✓	41	405TFS6036	E213	✓	59	444TFS6536	E629	✓	70
365TSDS16008	U449A		41	404TSDS16036	E780A	✓	44	405TFS6040	E314	✓	59	444TFS6540	E697		70
365TSDS16041	E782C	✓	44	404TDC6060	GT0046	✓	46	405TFS6086	E244	✓	59	444TFS7321	M924		158
365TSDS16042	E768C	✓	44	404TDC6086	GT0041	✓	45	405TFS6536	E628	✓	70	444TFS7262	Y392		188
365TSDS16044	U448A		41	404TDS4042	U903		39	405TFS6538	E681	✓	70	444TFS7403	M919		158
365STFC6003	E991A	✓	59	404TDS6060	E922	✓	44	405TFS6586	E645	✓	69	444TFS8106	L428		50
365STFC6006	E016	✓	59	404TDS6086	U270	✓	44	405TFS6587	E404	✓	69	444TFS8841	Y824	✓	187
365STFC6026	E804A	✓	59	404TDS7387	Y210		192	405TFS7297	Y391		188	444TGN16532	E582A	✓	81
365STFCA6001	GT1042	✓	62	404TDS14005	M849A		154	405TFS7612	M920		158	444TGN16533	U036A	✓	81
365STFCA6002	GT1142	✓	62	404TDS14074	M846B		154	405TFS8114	L427	✓	50	444TGN16580	E580A	✓	81
365STFCA6003	GT1242	✓	64	404TDS14081	M839A		154	405TFS14063	M921A		158	444TGS4042	U036		78
365STFS6001	E227	✓	59	404TDS14102	M836A		153	405TFS14087	M918A		158	445THFN8036	Y577	✓	89
365STFS6002	E322		59	404TDS16055	U903A		44	405TFS14328	Y1630		146	445THFN8040	Y578	✓	89
365STFS6501	E612	✓	69	404TFC6080	GT1141	✓	62	405TFS14554	Y822A	✓	187	445THFN8046	Y519	✓	89
365STFS6502	E665	✓	69	404TFC6086	GT1041	✓	62	405TFS16834	U879A	✓	65	445THFN8050	Y520	✓	89
365STFS6526	E455	✓	69	404TFS6086	E243	✓	59	405TGS4040	U035		78	445THFN9036	W612	✓	73
365STFS14009	Y1625		146	404TFS6586	E644	✓	69	405TGS6548	E594	✓	81	445THFN9037	W613	✓	73
365STGS16503	E575	✓	81	404TFS6592	E403	✓	69	405TGS6589	E577	✓	81	445THFN9038	W618		74
365STGS16532	U081A		81	404TFS8102	L426	✓	50	405TGS16539	U035A	✓	81	445THFN9086	W608		73
365TDCB6060	GT0043	✓	46	404TFS14088	M914A		158	444THFN8036	Y576	✓	89	445THFN9087	W614		73
365TDCB6086	GT0038	✓	45	404TGS6588	E574	✓	80	444THFN8046	Y518	✓	89	445THFN9102	W609		73
365TDS4041	E767		39	405THFS8036	Y575	✓	89	444THFN8384	Y589	✓	89	445THFN9106	W603		73
365TDS4328	M842A		154	405THFS8046	Y517	✓	89	444THFN19044	W606-P	✓	73	445THFN19033	W641		73
365TDS6060	E921		44	405THFS8378	Y588	✓	88	444THFN19081	W636		73	445THFN19034	W642	✓	74
365TDS7383	Y209		192	405THFS9036	W600	✓	73	444THFS9036	W606	✓	73	445THFN19070	W618-P	✓	74
365TDS14009	M845A		154	405THFS9040	W601	✓	73	444THFS9040	W607	✓	73	445THFN19071	W612-P	✓	73
365TDS14082	M835A		153	405THFS9086	W596		73	444THFS9101	W597		73	445THFN9001	W610		73
365TDS14101	M832A		153	405THFS19101	W590		73	444THFN19002	W604A		73	445THFN9005	W616		74
365TDS16064	E767A		44	405THFS19327	W600-P	✓	73	444TSDC16003	GT0054	✓	46	445THFN9026	W611	✓	73
365TDS16067	E766A		44	405THFS9001	W598	✓	73	444TSDS4010	U536	✓	145	445THFN9028	W617		74
365TDS16072	M742		154	405THFS9026	W599		73	444TSDS4332	U535	✓	145	445TSDS4001	E757	✓	39
365TFC6041	E805A	✓	59	405TSDC6007	GT0051	✓	46	444TSDS16034	U456A		41	445TSDS4332	U537	✓	145
365TFC6087	E993A	✓	59	405TSDS4006	U534	✓	145	444TSDS16038	E792A	✓	44	445TSDS14007	U539	✓	145
365TFC6036	GT1043	✓	62	405TSDS4332	U532	✓	145	444TSDS16003	U252	✓	44	445TSDS14051	U540	✓	145
365TFC6038	GT1243	✓	64	405TSDS4333	U533		145	444STFC6001	GT1048	✓	62	445TSDS16038	U400A	✓	44
365TFC6040	GT1143	✓	62	405TSDS6007	U251	✓	44	444STFC16002	GT1148	✓	62	445STFC6001	GT1051	✓	63
365TFC6080	GT1138	✓	62	405TSDS16005	U455A		41	444STFN16033	E810A	✓	60	445STFC6005	GT1151	✓	63
365TFC6086	GT1038	✓	62	405TSDS16038	E781A	✓	44	444STFS6001	E229	✓	60	445STFN6001	E230	✓	60
365TFS4040	E805		50	405TSDS16039	U454A		41	444TSTFS6501	E614	✓	70	445STFN6026	E811A	✓	60
365TFS7923	M916A		158	405STFC6001	GT1045	✓	62	444TSTFS6505	E494		70	445STFN6501	E615	✓	70
365TFS6036	E212	✓	59	405STFC6003	GT1245	✓	64	444TSTFS6526	E457	✓	70	445STFN6502	E495		70
365TFS6040	E315	✓	59	405STFC6005	GT1145	✓	62	444TSTFS16002	E324		60	445STFN6505	E449	✓	70
365TFS6536	E627	✓	69	405TSTFS6001	E228	✓	59	444TSTGN16502	U073A		81	445STFN6506	E496		70
365TFS6537	E680	✓	69	405TSTFS6005	E323		59	444TSTGN16531	U083A		81	445STFN6526	E458	✓	70
365TFS8115	L425	✓	50	405TSTFS6501	E613	✓	70	444TDC16077	GT0047	✓	46	445STFN6528	E459	✓	70
365TFS9230	Y390	✓	188	405TSTFS6502	E493		70	444TDC6060	GT0052	✓	46	445STFN14013	Y1634		147

Model Number/Catalog Number

MODEL NO.	CAT. NO.	STOCK	PAGE NO.	MODEL NO.	CAT. NO.	STOCK	PAGE NO.	MODEL NO.	CAT. NO.	STOCK	PAGE NO.	MODEL NO.	CAT. NO.	STOCK	PAGE NO.
445TSTFN14014	Y1637		147	447TSTDN7028	H814	✓	39,145	449TTFS6530	E770	✓	70	KIT 28TEBCNA	A701	✓	220
445TSTFN14066	Y1638		147	447TSTDN16004	U785	✓	44	449TTFS6536	E692	✓	70	KIT 32TEBC	A695	✓	220
445TSTFN14067	Y1635		147	447TSTDN16007	U788	✓	44	449TTFS6537	E691	✓	70	KIT 36TEBC	A696	✓	220
445TSTFN16004	E342	✓	60	447TSTDN16008	U791	✓	44	449TTFS6538	E690	✓	70	KIT 40TEBC	A697	✓	220
445TSTFN16033	E813A	✓	60	447TSTFC6005	GT1154	✓	63	449TTFS6540	E854	✓	70	KIT 44TEBC-313	A698	✓	220
445TSTGN16505	E584		81	447TSTFC16004	GT1054	✓	63	449TTFS6564	E856	✓	70	KIT 44TEBC-316	A699	✓	220
445TSTGN16506	U075A		81	447TSDC16077	GT0053	✓	46	449TTFS6577	E774		70	KIT 44TEBC-318	A700	✓	220
445TSTGN16531	U084A		81	447TTDN14087	H822A		39	449TTFS6578	E773	✓	70	KIT 56CDR-1	A435	✓	209
445TTDC6060	GT0055	✓	46	447TTDN16041	U789		44	449TTFS6582	E408		70	KIT 56CFR-1	A437	✓	210
445TTDC16076	GT0050	✓	46	447TTDN16046	U786	✓	44	449TTFS6587	E688		70	KIT 56 EXPR BOX	A800	✓	218
445TTDS4037	E745		39	447TTDN16077	U274	✓	44	449TTFS6588	E687	✓	70	KIT 100	A100	✓	216
445TTDS4070	U912		39	447TTDN16085	E797A		44	449TTFS7109	M931		158	KIT 103	A103	✓	222
445TTDS6060	E925	✓	44	447TTF6038	GT1055	✓	63	449TTFS8027	L463	✓	50	KIT 104	A104	✓	215
445TTDS7121	M848		154	447TTF6039	GT1155	✓	63	449TTFS8028	L455		50	KIT 105	A105	✓	217
445TTDS9477	Y213		192	447TTF6080	GT1153	✓	63	449TTFS8036	L467	✓	50	KIT 106	A106	✓	217
445TTDS14003	M861A		154	447TTF6087	GT1053	✓	63	449TTFS8037	L462	✓	50	KIT 107-637	A107	✓	214
445TTDS14062	M862A		154	449THFS8036	Y579	✓	89	449TTFS8038	L454	✓	50	KIT 109	A109	✓	222
445TTDS14063	M858A		154	449THFS8037	Y580	✓	89	449TTFS8076	L465		50	KIT 110	A110	✓	215
445TTDS14087	M851A		154	449THFS8046	Y531	✓	89	449TTFS8077	L457		50	KIT 111	A111	✓	216
445TTDS16041	U912A		44	449THFS8047	Y532	✓	89	449TTFS8086	L464	✓	50	KIT 112	A112	✓	215
445TTDS16076	U273	✓	44	449THFS8048	Y533	✓	89	449TTFS8087	L456	✓	50	KIT 113	A113	✓	215
445TTF6036	GT1052	✓	63	449THFS9027	W632		74	449TTFS8110	L449	✓	50	KIT 114	A114	✓	215
445TTF6037	GT1152	✓	63	449THFS9028	W626		74	449TTFS8111	L442		50	KIT 116	A116	✓	222
445TTF6080	GT1150	✓	62	449THFS9030	W619		74	449TTFS8581	Y857		187	KIT 140CB	A715	✓	220
445TTF6086	GT1050	✓	62	449THFS9036	W635		74	449TTFS14043	L469A	✓	50	KIT 140TCDR-1	A436	✓	209
445TTFN4575	U884		65	449THFS9088	W622		74	449TTFS14055	Y1642		147	KIT 140TCFR-1	A438	✓	210
445TTFN6028	U669A		60	449THFS9101	W615		73	449TTFS14056	Y1648		147	KIT 143SB	143A	✓	223
445TTFN6036	E215	✓	60	449THFS19079	W630		74	449TTFS14057	Y1645		147	KIT 143TCFN	A603	✓	210
445TTFN6037	E317		60	449THFS19092	W621		74	449TTFS14584	Y855A	✓	187	KIT 143TCTN-841	A181	✓	211
445TTFN6038	E247	✓	60	449THFS19342	W626-P	✓	74	449TTFS16094	E814A	✓	60	KIT 145SB	145A	✓	223
445TTFN6039	E326		60	449TSHFS9001	W634		74	449TTFS16333	E293		60	KIT 145TCFN	A655	✓	210
445TTFN6040	E287		60	449TSHFS9003	W624		74	449TTFS16334	E291		60	KIT 145TCTN-841	A262	✓	211
445TTFN6086	E246	✓	60	449TSTDN7001	H818	✓	39,145	449TTFS16534	E345		70	KIT 180/210CB	A720	✓	218
445TTFN6087	E289		60	449TSTDN7027	H816	✓	39,145	449TTFS16553	E776		70	KIT 180-210 TERM BLK	A1000	✓	212
445TTFN6536	E630	✓	70	449TSTDN14005	H819A	✓	39,145	449TTFS18105	L471		50	KIT 180CF4-5-1	A645	✓	210
445TTFN6537	E682		70	449TSTDN14033	H815A		39,145	449TTGS7036	H504	✓	81	KIT 180CF8-5-1	A644	✓	210
445TTFN6538	E631	✓	70	449TSTDN16003	U793	✓	44	449TTGS7037	H503		81	KIT 180R	A718	✓	220
445TTFN6540	E450		70	449TSTDN16004	U795	✓	44	449TTGS7068	H502		81	KIT 180TCD-WD	A160	✓	209
445TTFN6586	E647	✓	70	449TSTDN16005	U797	✓	44	449TTGS16537	E591	✓	81	KIT 180TCF-WD	A170	✓	210
445TTFN6587	E448	✓	70	449TSTGS14003	E595		81	449TTGS16585	U091A		81	KIT 180TCN4.5	A640	✓	210
445TTFN6590	E406		70	449TSTFS6001	E273		60	505UTDS805	M852		154	KIT 180TCN8.5	A641	✓	210
445TTFN6591	E407		70	449TSTFS6002	E272		60	505UTDS819	M856		154	KIT 180TCFS-841	A182	✓	211
445TTFN8040	L452	✓	50	449TSTFS6003	E271		60	505UTDS1584	Y219		192	KIT 180TDFR	A630	✓	211
445TTFN8041	L453		50	449TSTFS6501	E769	✓	70	505UTDS1590	Y220		192	KIT 180U	1814T	✓	223
445TTFN8102	L440		50	449TSTFS6502	E698	✓	70	505UTDS3999	M863A		154	KIT 182SB	182A	✓	223
445TTFN8115	L429	✓	50	449TSTFS6503	E699	✓	70	505UTDS5820	M860		154	KIT 184SB	184A	✓	223
445TTFN14003	M928A		158	449TSTFS8001	L466	✓	50	505UTDS14077	M859A		154	KIT 197	A197	✓	218
445TTFN14086	M926A		158	449TSTFS8002	L459	✓	50	5011LSTFS16031	E364		70	KIT 198	A198	✓	218
445TTFN14326	M929A		158	449TSTFS14007	L451A	✓	50	5011LSTFS16033	E366		70	KIT 199	A199	✓	218
445TTFN14330	M933A		158	449TSTFS14012	Y1640		147	5013LSTFS6595	E363		70	KIT 202	A202	✓	218
445TTFN14337	Y1636		147	449TSTFS14040	Y1641		147	976B399AAP9	A950	✓	219	KIT 201	A201	✓	218
445TTFN14338	Y1639		147	449TSTFS14044	Y1647		147	976B399AAP12	A951	✓	219	KIT 210TCDW	A606	✓	209
445TTFN14571	Y826A	✓	187	449TSTFS14045	Y1644		147	976B399AAP13	A952	✓	219	KIT 210TCD-WD	A161	✓	209
445TTFN16852	U882A		65	449TTDC16076	GT0056	✓	46	976B399ABP6	A953	✓	219	KIT 210TCFL	A204	✓	210
445TTFN16866	U881A		65	449TTDN7086	H820		39	976B399ABP9	A954	✓	219	KIT 210TCFS	A206	✓	210
445TTGN4030	U037		78	449TTDN14078	H821A		39	976B399ABP10	A955	✓	219	KIT 210TCFS-841	A183	✓	211
445TTGN4045	U038		78	449TTDN16076	U275	✓	44	KIT 391-200-01	A000	✓	219	KIT 210TCFW	A609	✓	210
445TTGN6538	E588	✓	81	449TTDN16077	U790		44	KIT 391-200-02	A001	✓	219	KIT 210TCF-WD	A171	✓	210
445TTGN6542	E585	✓	81	449TTF6080	GT1156	✓	63	KIT 3BRK1	A306	✓	213	KIT 210TCN	A646	✓	210
445TTGN6597	E583		81	449TTF6088	GT1056	✓	63	KIT 3BRK3	A301	✓	213	KIT 210R	A721	✓	220
445TTGN16543	U038A	✓	81	449TTF6037	E277		60	KIT 3BRK3A	A297	✓	213	KIT 234	A234	✓	218
445TTGN16544	U037A	✓	81	449TTF6038	E276		60	KIT 6BRK1	A307	✓	213	KIT 240	A240	✓	214
445TTGN16588	U090A	✓	81	449TTF6065	E292		60	KIT 6BRK3	A302	✓	213	KIT 241	A241	✓	214
447TSTDN7001	H178	✓	39,145	449TTF6087	E283		60	KIT 6BRK3A	A298	✓	213	KIT 242	A242	✓	214
447TSTDN7003	H193	✓	39,145	449TTF6088	E282	✓	60	KIT 10BRK	A303	✓	213	KIT 243	A243	✓	216
447TSTDN7005	H817	✓	39,145	449TTF6390	E284		60	KIT 10BRKA	A299	✓	213	KIT 244	A244	✓	216
447TSTDN7026	H812	✓	39,145	449TTF6527	E772	✓	70	KIT 21TEBC	A692	✓	220	KIT 245	A245	✓	216
447TSTDN7027	H813	✓	39,145	449TTF6528	E771	✓	70	KIT 25TEBCNA	A691	✓	220	KIT 247	A247	✓	218

Index

Model Number/Catalog Number

MODEL NO.	CAT. NO.	STOCK	PAGE NO.	MODEL NO.	CAT. NO.	STOCK	PAGE NO.	MODEL NO.	CAT. NO.	STOCK	PAGE NO.	MODEL NO.	CAT. NO.	STOCK	PAGE NO.
KIT 248	A248	✓	218	KIT 320TCD2-WD	A166	✓	209	KIT 440TCFN-841	A194	✓	211	KIT 175833	A589	✓	212
KIT 249	A249	✓	215	KIT 320TCDP	A613	✓	209	KIT 440TCFS	A229	✓	210	KIT 175834	A590	✓	212
KIT 250	A250	✓	215	KIT 320TCF-WD	A177	✓	210	KIT 440TCFS-841	A192	✓	211	KIT 175835	A596	✓	212
KIT 250-320 TERM BLK	A1001	✓	212	KIT 320TCF2-WD	A176	✓	210	KIT 440TSCDN	A293	✓	209	KIT 175836	A598	✓	212
KIT 250CB	A722	✓	218	KIT 320TCFP	A614	✓	210	KIT 440TSCDS	A231	✓	209	KIT 175844	A667	✓	210
KIT 250R	A725	✓	220	KIT 320TCFPA	A619	✓	210	KIT 440TSCFN	A621	✓	210	KIT 175890	A558	✓	212
KIT 250RFNA	A724	✓	220	KIT 320TCFS	A194	✓	210	KIT 440TSCFN-841	A195	✓	211	KIT 175900	A585	✓	212
KIT 250RFFPA	A723	✓	220	KIT 320TCFS-841	A187	✓	211	KIT 440TSCFS	A232	✓	210	KIT 175901	A586	✓	212
KIT 250TCD-WD	A163	✓	209	KIT 320TDFP	A632	✓	211	KIT 440TSCFS-841	A193	✓	211	KIT 175902	A587	✓	212
KIT 250TCD2-WD	A162	✓	209	KIT 320TDFPA	A657	✓	211	KIT 440U	44U40T	✓	223	KIT 175903	A588	✓	212
KIT 250TCDX	A612	✓	209	KIT 320TDFS	A658	✓	211	KIT 444SB	444B2	✓	223	KIT 175984	A554	✓	212
KIT 250TCF-WD	A173	✓	210	KIT 320U	32U28T	✓	223	KIT 444/5TCD-WD	A417	✓	209	KIT 175985	A581	✓	212
KIT 250TCF2-WD	A172	✓	210	KIT 324SB	324B2	✓	223	KIT 444/5TCD2-WD	A416	✓	209	KIT 175986	A555	✓	212
KIT 250TCFL	A209	✓	210	KIT 326SB	326B2	✓	223	KIT 444/5TCF-WD	A427	✓	210	KIT 175987	A582	✓	212
KIT 250TCFL-R	A1209	✓	210	KIT 364-445CB	A119	✓	218	KIT 444/5TCF2-WD	A426	✓	210	KIT 175988	A556	✓	212
KIT 250TCFNA	A284	✓	210	KIT 360BRFSR-314	A755	✓	220	KIT 445SB	445B2	✓	223	KIT 175989	A583	✓	212
KIT 250TCFNA-841	A184	✓	211	KIT 360 TERM BLK	A1002	✓	212	KIT 447/9TCD-WD	A419	✓	209	KIT 175990	A557	✓	212
KIT 250TCFP	A601	✓	210	KIT 360TCD-WD	A169	✓	209	KIT 447/9 TERM BLK	A1004	✓	212	KIT 175991	A584	✓	212
KIT 250TCFPA	A239	✓	210	KIT 360TCD2-WD	A168	✓	209	KIT 447/9TCF-WD	A429	✓	210	KIT 175994	A559	✓	212
KIT 250TDFNA	A648	✓	211	KIT 360TCD5	A216	✓	209	KIT 447/9TCF2-WD	A428	✓	210	KIT 175995	A580	✓	212
KIT 250TDFPA	A647	✓	211	KIT 360TCF-WD	A179	✓	210	KIT 447SB	447B2	✓	223	KIT 631475	A561	✓	212
KIT 250U	25U21T	✓	223	KIT 360TCF2-WD	A178	✓	210	KIT 449BBFS	A761	✓	220	KIT 635115	A569	✓	212
KIT 251	A251	✓	215	KIT 360TCFS	A197	✓	210	KIT 449BBFS-319	A788	✓	220	KIT 711485	A562	✓	212
KIT 252	A252	✓	215	KIT 360TCFSR	A395	✓	210	KIT 449BBFS-322	A787	✓	220	KIT 715130	A570	✓	212
KIT 253	A253	✓	215	KIT 360TCFSR-841	A188	✓	211	KIT 449BRFS	A758	✓	220	KIT 805165	A571	✓	212
KIT 254	A254	✓	215	KIT 360TDFC	A637	✓	211	KIT 449SB	449B2	✓	223	KIT 905165	A572	✓	212
KIT 254SB	254B2	✓	223	KIT 360TSCDS	A199	✓	209	KIT 449TCFS	A623	✓	210	KIT 1005215	A573	✓	212
KIT 256	A256	✓	217	KIT 360TSCFSR	A396	✓	210	KIT 449TSCFS-1	A624	✓	210	KIT 1125215	A574	✓	212
KIT 256SB	256B2	✓	223	KIT 360TSCFSR-841	A189	✓	211	KIT 449TSCFS-2	A625	✓	210	KIT 1325265	A575	✓	212
KIT 257	A257	✓	217	KIT 360U	36U32T	✓	223	KIT 649R	A649	✓	211	KIT 1605300	A576	✓	212
KIT 258	A258	✓	217	KIT 364SB	364B2	✓	223	KIT 650R	A650	✓	211	KIT 1805300	A577	✓	212
KIT 259	A259	✓	216	KIT 365SB	365B2	✓	223	KIT 651R	A651	✓	211	KIT 2005350	A578	✓	212
KIT 261	A261	✓	218	KIT 370-3	A371	✓	216	KIT 903	A903	✓	213	KIT 2255400	A579	✓	212
KIT 277	A277	✓	216	KIT 370-4	A372	✓	216	KIT 904	A904	✓	213	KIT 8014100	A563	✓	212
KIT 278	A278	✓	216	KIT 370-5	A373	✓	216	KIT 905	A905	✓	213	KIT 9014115	A564	✓	212
KIT 279	A279	✓	214	KIT 370-7.5	A375	✓	216	KIT 906	A906	✓	213	KIT 10014130	A565	✓	212
KIT 280	A280	✓	214	KIT 370-10	A376	✓	216	KIT 907	A907	✓	213	KIT 11214130	A566	✓	212
KIT 280CB	A729	✓	218	KIT 370-15	A378	✓	216	KIT 908	A908	✓	213	KIT 13214165	A567	✓	212
KIT 280R	A728	✓	220	KIT 370-17.5	A379	✓	216	KIT 909	A909	✓	213	KIT 16014215	A568	✓	212
KIT 280RFN	A727	✓	220	KIT 370-20	A380	✓	216	KIT 910	A910	✓	213	KIT A02H1024-BC LED	A668	✓	221
KIT 280RFNA	A731	✓	220	KIT 370-25	A381	✓	216	KIT 911	A911	✓	213	KIT A02H2048-BC LED	A669	✓	221
KIT 280RFFPA	A726	✓	220	KIT 370-30	A382	✓	216	KIT 175058	A626	✓	209	KIT A688-10	A688-10	✓	221
KIT 280TCD-WD	A165	✓	209	KIT 400-445 TERM BLK	A1003	✓	212	KIT 175059	A627	✓	209	KIT A688-20	A688-20	✓	221
KIT 280TCD2-WD	A164	✓	209	KIT 400BRFS-316	A756	✓	220	KIT 175060	A628	✓	209	KIT A688-25	A688-25	✓	221
KIT 280TCDCA	A1287	✓	209	KIT 400TCD-WD	A414	✓	209	KIT 175061	A654	✓	210	KIT A688-30	A688-30	✓	221
KIT 280TCDA	A1287	✓	209	KIT 400TCD2-WD	A415	✓	209	KIT 175066	A602	✓	209	KIT A688-50	A688-50	✓	221
KIT 280TCDP	A610	✓	209	KIT 400TCD5	A202	✓	209	KIT 175067	A622	✓	209	KIT A688-60	A688-60	✓	221
KIT 280TCF-WD	A175	✓	210	KIT 400TCFS	A223	✓	210	KIT 175068	A652	✓	210	KIT A688-100	A688-100	✓	221
KIT 280TCF2-WD	A174	✓	210	KIT 400TCFS-841	A190	✓	211	KIT 175077	A642	✓	210	KIT A690-15	A690-15	✓	221
KIT 280TCFN	A615	✓	210	KIT 400TCF-WD	A425	✓	210	KIT 175181	A600	✓	209	KIT BM6BRK	A312	✓	213
KIT 280TCFN-841	A185	✓	211	KIT 400TCF2-WD	A424	✓	210	KIT 175191	A653	✓	210	KIT BM6BRK115	A317	✓	213
KIT 280TCFNA	A618	✓	210	KIT 400TDFS	A634	✓	211	KIT 175296	A643	✓	210	KIT BM6BRK575	A315	✓	213
KIT 280TCFNA-841	A186	✓	211	KIT 400TSCDS	A225	✓	209	KIT 175601	A629	✓	209	KIT BM10BRK	A313	✓	213
KIT 280TCFP	A611	✓	210	KIT 400TSCFS	A226	✓	210	KIT 175614	A662	✓	218	KIT BM10BRK115	A318	✓	213
KIT 280TCFPA	A617	✓	210	KIT 400TSCFS-841	A191	✓	211	KIT 175619	A594	✓	212	KIT BM10BRK575	A316	✓	213
KIT 280TDFNA	A656	✓	211	KIT 400U	40U36T	✓	223	KIT 175691	A666	✓	210	KIT BRK-3 115/230	A1306	✓	213
KIT 280TDFP	A631	✓	211	KIT 404SB	404B2	✓	223	KIT 175810	A554A	✓	212	KIT BRK-3 208-230/460	A1301	✓	213
KIT 280U	28U25T	✓	223	KIT 405SB	405B2	✓	223	KIT 175811	A555A	✓	212	KIT BRK-3 575	A1297	✓	213
KIT 281	A281	✓	214	KIT 440-7.5	A445	✓	216	KIT 175812	A556A	✓	212	KIT BRK-6 115/230	A1307	✓	213
KIT 282	A282	✓	214	KIT 440-10	A446	✓	216	KIT 175817	A581A	✓	212	KIT BRK-6 208-230/460	A1302	✓	213
KIT 283	A283	✓	214	KIT 440-12.5	A447	✓	216	KIT 175818	A582A	✓	212	KIT BRK-6 575	A1298	✓	213
KIT 284SB	284B2	✓	223	KIT 440-15	A448	✓	216	KIT 175819	A583A	✓	212	KIT BRK-10208-230/460	A1303	✓	213
KIT 286SB	286B2	✓	223	KIT 440-17.5	A449	✓	216	KIT 175827	A555B	✓	212	KIT BRK-10 575	A1299	✓	213
KIT 308	A308	✓	214	KIT 440BBFN	A760	✓	220	KIT 175828	A550	✓	212	KIT ENCB0X	A801	✓	221
KIT 311	A311	✓	218	KIT 440BRFN	A759	✓	220	KIT 175829	A551	✓	212	KIT EP2400	A496	✓	222
KIT 320CB	A730	✓	218	KIT 440BRFS-318	A757	✓	220	KIT 175830	A552	✓	212	KIT EPC260 2048	A686	✓	221
KIT 320RFFPA	A733	✓	220	KIT 440TCD5	A228	✓	209	KIT 175831	A553	✓	212	KIT HS201024-NV	A687	✓	221
KIT 320TCD-WD	A167	✓	209	KIT 440TCFN	A620	✓	210	KIT 175832	A582B	✓	212	KIT HS25A1024-NV	A746	✓	221

Model Number/Catalog Number

MODEL NO.	CAT. NO.	STOCK	PAGE NO.	MODEL NO.	CAT. NO.	STOCK	PAGE NO.	MODEL NO.	CAT. NO.	STOCK	PAGE NO.	MODEL NO.	CAT. NO.	STOCK	PAGE NO.
KIT HS25A2048-NV	A747	✓	221												
KIT HS351024-BC	A775	✓	221												
KIT HS351024-FC	A774	✓	221												
KIT HS351024-NV	A772	✓	221												
KIT HS352048-BC	A778	✓	221												
KIT HS352048-FC	A777	✓	221												
KIT HS352048-NV	A776	✓	221												
KIT HS35A1024-BC	A738	✓	221												
KIT HS35A1024-FC	A737	✓	221												
KIT HS35A1024-NV	A736	✓	221												
KIT HS35A2048-FC	A740	✓	221												
KIT HS35A2048-NV	A739	✓	221												
KIT HS35B1024-BC	A781	✓	221												
KIT HS35B1024-FC	A783	✓	221												
KIT HS35B1024-NV	A779	✓	221												
KIT HS35B2048-BC	A782	✓	221												
KIT HS35B2048-FC	A784	✓	221												
KIT HS35B2048-NV	A780	✓	221												
KIT HS35M1024	A742	✓	221												
KIT HS35A/B1024-FC	A783A	✓	221												
KIT HS35A/B2048-FC	A784A	✓	221												
KIT HS35A/B1024-NV	A779A	✓	221												
KIT HS35A/B2048-NV	A780A	✓	221												
KIT HSD351024-FC	A712	✓	221												
KIT HSD351024-NV	A711	✓	221												
KIT L449BBFS-322	A795	✓	220												
KIT L449TEBC	A796	✓	220												
KIT LDRDCR-M	A803	✓	218												
KIT LKSR02	A763	✓	221												
KIT LKSR03	A764	✓	221												
KIT LKSR512	A785	✓	221												
KIT LKSR-CFACE	A786	✓	221												
KIT M31024-FC	A754	✓	221												
KIT M31024-NV	A753	✓	221												
KIT M561024-BC	A794	✓	221												
KIT M561024BRK-140	A748	✓	221												
KIT M561024BRK-182	A749	✓	221												
KIT M561024-NV	A793	✓	221												
KIT M851024BRK-184	A750	✓	221												
KIT M851024BRK-210	A751	✓	221												
KIT M851024BRK-250	A752	✓	221												
KIT SGR-0.625-UK	A499-1	✓	222												
KIT SGR-0.875-UK	A499-2	✓	222												
KIT SGR-1.125-UK	A499-3	✓	222												
KIT SGR-1.375-UK	A499-4	✓	222												
KIT SGR-1.625-UK	A499-5	✓	222												
KIT SGR-1.875-UK	A499-6	✓	222												
KIT SGR-2.125-UK	A499-7	✓	222												
KIT SGR-2.375-UK	A499-8	✓	222												
KIT SGR-2.875-UK	A499-9	✓	222												
KIT SGR-3.375-UK	A499-10	✓	222												
KIT SGR-11.2	A500-5	✓	222												
KIT SGR-14.4	A500-8	✓	222												
KIT SGR-20.7	A500-14	✓	222												
KIT SGR-27.1	A500-20	✓	222												
KIT SGR-33.4	A500-26	✓	222												
KIT SGR-39.8	A500-32	✓	222												
KIT SGR-46.1	A500-38	✓	222												
KIT SGR-52.5	A500-44	✓	222												
KIT SGR-58.8	A500-50	✓	222												
KIT SGR-71.5	A500-62	✓	222												
KIT SGR-84.2	A500-74	✓	222												
KIT SL561024-182NV	A789	✓	221												
KIT SL851024-184NV	A790	✓	221												
KIT SL851024-210NV	A791	✓	221												
KIT SL851024-250NV	A792	✓	221												
KIT STUBSHAFT 1IN	A807	✓	221												
KIT VRT87BRK	A157	✓	213												

Regal Beloit America, Inc.

Terms and Conditions of Sale

ALL QUOTATIONS ARE OFFERED AND ALL PURCHASE ORDERS ARE ACCEPTED BY SELLER SUBJECT ONLY TO THESE TERMS AND CONDITIONS.

1. DEFINITIONS:

"Buyer" means the entity to which Seller is selling Products or Services under a Contract. "Contract" means the agreement between Buyer and Seller governing the sale of Products and/or Services by Seller to Buyer. These Terms and Conditions, the Quotation (if one is issued by Seller), any purchase order acknowledgement (if one is issued by Seller), and Buyer's purchase order (except to the extent that it conflicts with these Terms and Conditions, the Quotation, and/or the order acknowledgement) constitute the Contract.

"Products" means the equipment, parts, materials, supplies, and other goods that Seller has agreed to supply under the Contract. References in these Terms and Conditions to the purchase and sale of Products may mean, where applicable, the licensing of Software loaded on or provided with the Products.

"Quotation" means Seller's statement identifying the Products and Services, together with any quantity, price, delivery schedule, and/or other terms and conditions (in addition to or different from these Terms and Conditions), offered by Seller for sale to Buyer. A Quotation that incorporates these Terms and Conditions by reference shall be deemed to include these Terms and Conditions, whether or not Seller provides a complete copy of these Terms and Conditions to Buyer with the Quotation, with a purchase order acknowledgement, or with an invoice. Where there is a conflict between these Terms and Conditions and other provisions of the Quotation, the latter shall control.

"Services" means the services that Seller has agreed to provide under the Contract.

"Software" means software loaded on or provided with the Products.

"Seller" means the Regal entity -- whether Regal Beloit Corporation ("RBC") or an RBC subsidiary -- supplying Products and/or providing Services under the Contract.

"Terms and Conditions" means these "Terms and Conditions of Sale."

2. CONTRACT FORMATION:

No agreement or understanding, oral or written, purporting to modify these Terms and Conditions shall be binding on Seller unless it is made in writing, specifically stating that it is a modification of these Terms and Conditions and it is signed by Seller's authorized representative. No course of dealing, usage of trade, or course of performance shall be relevant to explain or supplement any of these Terms and Conditions. If these Terms and Conditions are deemed an offer, Buyer's acceptance of Seller's offer is expressly limited to acceptance of these Terms and Conditions. Fulfillment of Buyer's order does not constitute acceptance of any of Buyer's terms and conditions and does not modify or amend these Terms and Conditions. Buyer's purchase order for the purchase of Products and/or for the performance of Services shall constitute Buyer's assent to these Terms and Conditions. Any terms and conditions contained in Buyer's purchase order or other form of communication from Buyer that are additional to or different from these Terms and Conditions, shall be deemed rejected by Seller, unless expressly accepted in writing by Seller's authorized representative. Alternatively, if these Terms and Conditions are deemed to be a response to, an acceptance of, or a written confirmation of, Buyer's offer, whether provided in the form of a purchase order or otherwise, Seller's acceptance is expressly conditioned upon Buyer's assent to these Terms and Conditions. Buyer's acceptance of Products tendered to Buyer by Seller shall constitute Buyer's express assent to all of the terms and conditions contained in these Terms and Conditions. All proposals, negotiations and representations, if any, made prior to or with reference hereto are hereby superseded by these Terms and Conditions. References in this Section to "these Terms and Conditions" shall be deemed to mean these Terms and Conditions and Seller's Quotation, if Seller has issued a Quotation.

3. ACCEPTANCE OF PURCHASE ORDERS:

No Buyer purchase order shall be binding on Seller until accepted in writing by Seller, and Seller shall have no liability to Buyer with respect to purchase orders that are not accepted. Shipment against a purchase order shall be deemed to constitute Seller's acceptance thereof, subject to these Terms and Conditions. All purchase orders shall be subject to these Terms and Conditions, whether or not the purchase orders so state. Purchase orders accepted by Seller may not be cancelled or modified by Buyer without the prior written consent of Seller.

4. QUOTATIONS:

Quotations shall expire and shall be void thirty (30) days from date of the Quotation, unless otherwise specified in the Quotation. The Quotation may be modified or withdrawn by Seller at any time before Seller's receipt of Buyer's conforming acceptance.

5. PRICES; PRICE CHANGES:

(a) Products. The price of the Products sold pursuant to the Contract shall be as set forth in the Quotation. If price is not specified in the Quotation, price shall be based upon Seller's prices in effect at the time of shipment. Published prices are for Products of Seller's current standard design and constructed of standard materials. Variation from the standard design and/or materials requires special pricing. Seller reserves the right at any time, and without incurring any obligation, to discontinue the manufacture of any model, to withdraw products from sale, to make changes in design, and/or to add improvements to products. Price also shall be based on freight rates in effect at the time of shipment. Where applicable, in the event of an increase in the applicable freight rates before the shipment of Products, such changes will be for the account of Buyer. Price advances, discounts, extras and other terms and conditions are subject to change without notice. Unless otherwise provided in the Quotation, price is based on delivery in accordance with the "Delivery" section below. Prices include Seller's standard packing.

(b) Services. Services prices are based on normal business hours (8 AM to 5 PM Monday through Friday). Overtime and Saturday hours will be billed at one and one half (1.5) times the normal business hour hourly rate. Sunday hours will be billed at two (2) times the normal business hours hourly rate; holiday hours will be billed at three (3) times the normal business hours hourly rate.

6. TAXES, DUTIES AND FEES:

: Seller shall be responsible for taxes measured on Seller's net income based upon per-

formance of, or payment for, work under the Contract ("Seller Taxes"). Buyer shall be responsible for all other taxes, duties, fees or other charges of any kind (including, but not limited to any manufacturer's tax, retailers' occupation tax, use tax, sales tax, excise tax, duty, custom, inspection or testing fee, value added tax, or any other tax, fee or charge of any nature whatsoever) imposed by any governmental authority against Buyer, Seller or Seller's suppliers and/or contractors, based upon the Contract between Seller and Buyer. In the event Seller is required to pay any such tax, fee or charge, regardless whether such tax, fee or charge is imposed before or after Seller's delivery of the Products and/or Buyer's payment under the Contract, Buyer shall reimburse Seller therefor. In lieu of such reimbursement, Buyer shall provide Seller, at the time the order is submitted, with an exemption certificate or other document acceptable to the authority imposing such tax, fee or charge. If Seller's prices include any taxes, duties or fees (other than Seller Taxes), any change in such taxes, duties and/or fees shall be the basis for a price adjustment.

7. TERMS OF PAYMENT:

(a) Terms. Terms of payment are cash in full, without set-off or discount, in U.S. dollars, and by wire transfer, no later than thirty (30) days from date of invoice.

(b) Payment Default. If Buyer defaults in any payment when due, or in the event that any voluntary or involuntary bankruptcy or insolvency proceedings involving Buyer are initiated by or against Buyer, then the whole Contract price shall immediately become due and payable upon demand, or Seller, at its option and without prejudice to its other lawful remedies, may defer delivery or cancel the Contract. Where delivery is deferred and Seller does not demand immediate payment of the full Contract price, pro-rata payments shall become due as shipments are made.

(c) Buyer Financial Condition. If, during the period of performance of the Contract, the financial condition of Buyer is determined by Seller not to justify the terms of payment specified, Seller may demand full or partial payment in advance before proceeding with the work, or satisfactory security or guarantees that invoices will be promptly paid when due, or, at its option, without prejudice to other lawful remedies, may defer delivery or cancel the Contract.

(d) Delay. If delivery is delayed by Buyer, which delay must be consented to by Seller, Seller may store the Products in accordance with subsection 8(e) "Storage" below and Seller may submit a new estimate of cost for completion based on prevailing conditions. Payments shall become due from the date on which Seller is prepared to deliver the Products and storage shall be the Buyer's risk and expense as provided in subsection 8(g) "Storage" below. If manufacture is delayed by Buyer for any cause, a partial payment based upon the proportion of the order completed shall become due from the date on which Seller is notified of the delay.

(e) Late Payment Charge. Buyer shall pay a late payment charge on all amounts not paid in full when due at the rate of one and one half percent (1.5%) per month or at the maximum legally permissible rate, whichever is lower.

(f) Exceptions. Supplement A to these Terms and Conditions lists Seller business units for which payment terms vary from payment terms set forth in this Section 7.

8. EDELIVERY; TITLE TRANSFER; RISK OF LOSS/DAMAGE:

(a) Delivery - U.S. Buyer. For sales in the U.S. that do not involve export from the U.S., Seller shall deliver Products to Buyer EXW Seller's U.S. point of shipment (Incoterms® 2010). The point of shipment shall be the shipping dock of Seller's factory, warehouse or other facility that Seller designates as its discretion as point of shipment from time to time.

(b) Sales Involving Exports from U.S.

(1) Delivery - U.S. Buyer; Subsequent Drop Shipment to Location Outside U.S. For sales, in the U.S. to a U.S. Buyer, which involve drop shipment at Buyer's request and/or on Buyer's behalf, to a location outside the U.S., Seller shall deliver the Products to Buyer EXW Seller's U.S. point of shipment (Incoterms® 2010). The point of shipment shall be the shipping dock of Seller's factory, warehouse or other facility that Seller designates at its discretion as its point of shipment from time to time. Buyer is responsible for all transportation charges incurred after delivery of the Products to the carrier or Buyer at the point of shipment and shall reimburse Seller for any transit insurance or freight pre-paid for the Products by Seller. Buyer shall bear the risk of loss and/or damage in transportation. Buyer is responsible for filing any export documents required for export from the U.S.

(2) Delivery - Non-U.S. Buyer; Routed Export Transactions. For sales in the U.S. to a non-U.S. Buyer, Seller shall deliver Products to Buyer's freight forwarder EXW Seller's U.S. point of shipment (Incoterms® 2010). The point of shipment shall be the shipping dock of Seller's factory, warehouse or other facility that Seller designates at its discretion as its point of shipment from time to time. In a "Routed Export Transaction," as defined in the U.S. Census regulations, 15 CFR Section 30.3, where Buyer is a non-U.S. entity, Buyer shall authorize Buyer's designated freight forwarder or Seller to facilitate the export of the Products from the U.S. and to prepare and file export documentation with respect to such export transaction (hereafter, to "Facilitate the Export"). If Buyer authorizes its designated freight forwarder to Facilitate the Export, Buyer's freight forwarder shall provide Seller with a copy of the final export documentation and proof of filing. If Buyer authorizes Seller to Facilitate the Export, Buyer shall cause Buyer's freight forwarder to provide Seller the information needed by Seller to Facilitate the Export. Buyer shall give timely notice to Seller identifying whom it has designated to Facilitate the Export.

(c) Delivery Dates. Delivery dates are approximate, are not guaranteed and are based upon prompt receipt by Seller from Buyer of all necessary shipping and other information. Seller may deliver in advance of the delivery schedule. Seller reserves the right to make delivery in installments, with all installments to be separately invoiced and paid for by Buyer when due per invoice, without regard to subsequent deliveries. Delivery of the Products to a commercial carrier at the shipping point shall constitute delivery to Buyer.

(d) Title Transfer. Title to Products shall pass to Buyer upon the earlier of delivery of the Products to the carrier or Buyer at the point of shipment in accordance with subsection (a) above, except that, for Routed Export Transactions, title shall transfer to Buyer upon delivery to Buyer's designated freight forwarder. Subject to applicable law, Seller, upon

Regal Beloit America, Inc.

Terms and Conditions of Sale

notice to Buyer, may retain title to the Products until such time as Seller receives payment in full from Buyer. Title to Software shall not pass to Buyer and is subject to the applicable license.

(e) Risk of Loss/Damage. Risk of loss and/or damage shall pass to Buyer upon delivery in accordance with subsection (a) above, except that, for Routed Export Transactions, risk of loss and/or damage shall pass upon delivery of the Products to Buyer's designated freight forwarder.

(f) Delivery by Seller's Carrier. Where the parties agree that delivery shall be made at a location other than Seller's point of shipment, where Seller will deliver using its carrier or Seller's privately owned or leased trucks, unloading at the agreed location shall constitute delivery to Buyer. Freight and handling charges by Seller may not reflect actual freight charges prepaid to the carrier by Seller due to incentive discounts earned by Seller based upon Seller's aggregate volume of freight tendered to a carrier or when a carrier must be used which charges a rate which is different than the rate upon which Seller's freight and handling charges were based. When shipments are delivered in Seller's privately owned or leased trucks, Buyer will be charged an amount approximating the prevailing common carrier rate.

(g) Storage. In the event that Buyer is unable to accept delivery of the Products at time of shipment, Seller shall invoice Buyer for the full purchase price as if shipment had been made and: (i) if Seller is able to store such Products in its own facilities, Buyer will pay Seller the reasonable handling and storage charges for the period of such storage, or (ii) if Seller is unable to store such goods at its own facility, Seller reserves the right to arrange handling and storage in a suitable bonded warehouse for Buyer at Buyer's expense. In cases where handling and storage become necessary, it shall be Buyer's responsibility to notify Seller when shipment is to be made. Seller will make necessary arrangements for shipment at Buyer's expense.

9. EXCUSABLE DELAYS; FORCE MAJEURE:

(a) Excuse of Performance. Seller shall not be liable for any ordinary, incidental, or consequential loss or damage as a result of Seller's delay in or failure of delivery, or installation of Products or performance of Services due to (i) any cause beyond Seller's reasonable control, (ii) an act of God, act of Buyer, embargo or other government act, authority, regulation or request, fire, theft, accident, strike, slowdown or other labor disturbance, war, armed conflict, act or threat of terrorism, riot, epidemic, delay in transportation, or (iii) inability to obtain necessary labor, materials, components, or facilities. Should any of the aforementioned events occur, Seller, at its option, may cancel Buyer's order with respect to any undelivered Products or incomplete Services or extend the delivery date for a period equal to the time lost because of delay. Notice of such election shall be given promptly to Buyer. In the event Seller elects to so cancel the Contract, Seller shall be released of and from all liability for failure to deliver the Products or to perform the Services, including, but not limited to, any and all claims on behalf of Buyer for lost profits, or any other claim of any nature which Buyer might have. If shipping or progress of the work is delayed or interrupted by Buyer, directly or indirectly, Buyer shall pay Seller for all additional charges resulting therefrom.

(b) Allocation. If Seller determines that its ability to meet the demand for products, including the Products, or to obtain labor, materials, components or facilities is hindered, limited or made impracticable due to causes set forth in subsection (a) above, Seller may allocate its available supply of products, including the Products, among itself and its purchasers on such basis as Seller determines to be equitable without liability for any failure of performance which may result therefrom.

10. LIMITED WARRANTY.

(a) Scope and Period.

(1) Products. Seller warrants that the Products shall be delivered free from defects in material, workmanship and title and shall conform to Seller's specification agreed upon in a written and signed agreement by Buyer and Seller, if applicable, for the Products. This warranty shall expire twelve (12) months from first use of the Product or eighteen (18) months from date of manufacture of the Product, whichever occurs first.

(2) Repaired and/or Replaced Products and/or Parts of Products. Seller warrants that the repaired or replaced Products or parts of Products shall be delivered free from defects in material, workmanship and title. In the case of repaired or replaced Products or parts of Products comprising warranty remedies for Products, this warranty shall expire upon expiration of the warranty period applicable to the Products originally supplied by Seller. In the case of other repaired or replaced Products or parts of Products, this warranty shall expire twelve (12) months from the date of repair or manufacture of the Products or parts of the Products.

(3) Services. Seller warrants that the Services shall be performed in a competent and diligent manner in accordance with any mutually agreed specification. This warranty shall expire ninety (90) days from the date of completion of such Services.

(4) Software. Seller warrants that the Software shall execute, at time of delivery, in accordance with the specification agreed upon in a written and signed agreement by Buyer (as licensee) and Seller (as licensor) when properly installed in the Products. The warranty shall expire six (6) months from date of manufacture of the first Product in which the Software is loaded.

(5) Applicability. This warranty shall apply to any Products and/or Software bought, acquired, and/or used by an entity that, or person who, acquires the Products and/or Software from Buyer (a "Transferee"), except that any claim made against Seller pursuant to this warranty shall be made by Buyer only. Seller shall not be bound by this Section 10 to satisfy a claim under this Section made against Seller by a Transferee, whether such Transferee is a direct or indirect Transferee of Buyer, Buyer shall provide any Transferee of a Product or Software written conspicuous notice of Sections 10 and 11 hereof.

(6) Exceptions. Supplement B to these Terms and Conditions lists Seller Products, parts, Services and Software for which Seller's warranties vary from the warranties set forth in this subsection 10(a).

(b) Remedies.

(1) Products. If, prior to expiration of the warranty period set forth in subsection 10(a)(1), above, any Products shall be proved to Seller's satisfaction to be defective or nonconforming with the warranty set forth therein, Seller will repair or replace such defective Products or components thereof, FCA Seller's factory, warehouse or other facility that Seller designates at its discretion as point of shipment from time to time (Incoterms® 2010), or will refund or provide Buyer with a credit in the amount of the purchase price paid therefor by Buyer, at Seller's sole option. Buyer's exclusive remedy and Seller's sole obligation under this warranty shall be limited to such repair or replacement, FCA factory, warehouse or other facility that Seller designates at its discretion as point of shipment from time to time (Incoterms® 2010), or refund or credit by Seller, and shall be conditioned upon Seller's receiving written notice of any defect and/or nonconformance within a reasonable period of time, but in no event more than thirty (30) days, after it was discovered or by reasonable care should have been discovered. All claims not made in writing and received by Seller within such thirty (30) day period shall be deemed waived. In no event shall Seller's liability for such defective or nonconforming Products exceed the purchase price paid by Buyer for such Products. With prior approval from Seller, Buyer shall return the alleged defective Product or part, freight prepaid, for Seller's inspection, and no other Products shall be returned to any Seller office, factory, warehouse, authorized service center or other facility, without Seller's written consent.

(2) Repaired and/or Replacement Products and/or Parts of Products. If prior to the expiration of the applicable warranty period set forth in subsection 10(a)(2) above, any replacement Products and/or parts of Products shall be proved to Seller's satisfaction to be defective or nonconforming with the warranty set forth therein, the remedy set forth in subsection 10(b)(1) above shall apply to such replacement Products and/or parts of Products.

(3) Services. If, prior to expiration of the warranty period set forth in subsection 10(a)(3), above, any Services shall be proved to Seller's satisfaction to be nonconforming with the warranty set forth therein, Seller will re-perform such nonconforming Services. If the Services cannot be re-performed, Seller, at its option, shall refund or credit monies paid by Buyer for such nonconforming Services.

(4) Software. If, prior to expiration of the warranty period set forth in subsection 10(a)(4) above, (i) Buyer provides, in writing, a complete description of the claimed nonconformance in the Software, and (ii) the Software is proven to Seller's satisfaction to be so nonconforming with the warranty set forth therein, Seller will correct the nonconformance by, at its option: (i) modifying or making available to Buyer instructions for modifying the program causing such nonconformance, or (ii) making available a corrected or replacement program FCA Seller's factory, warehouse or other facility that Seller designates at its discretion as point of shipment from time to time (Incoterms® 2010).

(c) Exclusions - The warranties set forth in this Section 10 do not cover:

(1) shipping expenses to and from Seller's office, factory, warehouse, authorized service center or other destination designated by Seller for repair or replacement of defective Products or any tax, duty, custom, inspection or testing fee, or any other charge of any nature related thereto;

(2) costs of removing defective Products from, and/or disassembling, equipment in which Products are assembled or reinstalling Products and/or reassembling such equipment, or testing repaired or replaced Products and/or the equipment;

(3) field service travel and living costs and expenses;

(4) Products subjected to abuse, neglect, negligence, misuse, misapplication, accident, damages by circumstances beyond Seller's control, improper installation (if by anyone other than Seller), improper operation (including, but not limited to, operation in excess of rated capacity or otherwise not in accordance with installation, maintenance, or operating instructions or requirements) improper maintenance, improper storage, and/or any other than normal use or service;

(5) Products maintained, serviced, repaired or altered by anyone other than Seller or Seller's authorized service agencies;

(6) Products and/or parts not manufactured by Seller; for Products furnished by Seller, but manufactured by others, Seller will assign to Buyer the written warranty, if any, of the manufacturer, if assignment is reasonably practicable; however, Seller does not adopt or guarantee or represent that the manufacturer will comply with any of the terms of the warranty of such manufacturer; but, in no event shall Seller's obligations be greater than those provided under Seller's warranty set forth in this Section 10; and/or

(7) failures of the Software to be interruption-free or error-free or to meet Buyer's or any other party's requirements; and, problems caused by use of the Software in conjunction with third-party software, hardware, or products.

(d) DISCLAIMER: THE FOREGOING WARRANTIES ARE IN LIEU OF ALL OTHER EXPRESS AND IMPLIED WARRANTIES, ARISING BY OPERATION OF LAW OR OTHERWISE, INCLUDING, WITHOUT LIMITATION, THE IMPLIED WARRANTIES OF MERCHANTABILITY AND FITNESS FOR A PARTICULAR PURPOSE, WHETHER OR NOT THE PURPOSE OR USE HAS BEEN DISCLOSED TO SELLER IN SPECIFICATIONS, DRAWINGS, OR OTHERWISE AND WHETHER OR NOT SELLER'S PRODUCTS ARE SPECIFICALLY DESIGNED AND/OR MANUFACTURED BY SELLER FOR BUYER'S USE OR PURPOSE. NO EMPLOYEE, REPRESENTATIVE, OR AGENT OF SELLER OTHER THAN AN OFFICER OF SELLER IS AUTHORIZED TO ALTER OR MODIFY ANY PROVISION OF THIS SECTION 10 OR TO MAKE ANY GUARANTEE, WARRANTY, OR REPRESENTATION, EXPRESS OR IMPLIED, ORALLY OR IN WRITING, WHICH IS CONTRARY TO THE FOREGOING. Except where Buyer and Seller agree in a written and signed agreement upon the specifications applicable to the Products, Software, and/or Services, any description of the Products, Software, and/or Services, whether in writing or made orally by Seller or Seller's agents, specifications, samples, models, bulletins, drawings, diagrams, engineering sheets or similar materials used in connection with Buyer's order are for the sole purpose of identifying the Products and shall not be construed as an express or implied warranty. Any suggestions by Seller or Seller's agents regarding use, application or suitability of the

Regal Beloit America, Inc.

Terms and Conditions of Sale

Products shall not be construed as an express or implied warranty unless confirmed to be such in writing by Seller's authorized officer.

11. LIMITATIONS OF REMEDY AND LIABILITY:

(a) Breach of Warranty Claims. Buyer's only remedy for breach of any warranty under the Contract, other than the warranty provided under Section 13 "Intellectual Property Indemnity," shall be the applicable remedy set forth in Section 10 "Limited Warranty" above. Seller's total liability for any and all breach of warranty claims under the Contract shall not exceed the purchase price allocable to the Product, Software or Service or part thereof which gives rise to the claim.

(b) Other Claims. Seller's liability for any claim other than a breach of warranty claim under Section 10 "Limited Warranty," whether in contract, negligence, tort, strict liability, indemnity or otherwise for any loss or damage arising out of, connected with, or resulting from the Contract or the performance or breach thereof, or from the design, manufacture, sale, delivery, resale, repair, replacement, installation, technical direction of installation, inspection, operation or use of any Products covered by or furnished under the Contract or from Services rendered under the Contract, shall in no case (except as provided in Section 13 "Intellectual Property Indemnity") exceed five percent (5%) of the purchase price allocable to the Products or part thereof or Services giving rise to the claim.

(c) Consequential Damage Disclaimer. SELLER SHALL NOT BE LIABLE FOR AND DISCLAIMS ALL CONSEQUENTIAL, INCIDENTAL, CONTINGENT, SPECIAL OR PUNITIVE DAMAGES WHATSOEVER. Seller shall not be liable for lost profits or revenues, loss of use of the Products, Software or any related equipment or systems, cost of capital, cost of substitute products, cost of facilities or services, business interruption, downtime, shutdown, or slowdown costs, any other types of economic loss, penalties, special or punitive damages, and claims of Buyer's customers for any such damages.

(d) Expiration of Claims. All claims against Seller arising out of or related to the Contract or the performance or breach thereof shall expire unless made and presented to Seller in writing by Buyer before expiration of the applicable warranty period.

(e) Precedence. The limitations of this Section shall apply regardless of whether a claim is based in contract, tort (including negligence), warranty, strict liability, intellectual property, or otherwise, and shall take precedence over any conflicting terms and conditions, except where the limitations of liability of such conflicting terms limit Seller's liability further.

12. INDEMNITY:

(a) Third party claims. Each of Buyer and Seller (each an "Indemnified Party" and an "Indemnifying Party") shall indemnify the other party from and against claims brought by a third party, for bodily injury or damage to the third party's tangible property, to the extent such injury and/or damage is caused by the negligence of the Indemnifying Party, provided that the Indemnified Party gives the Indemnifying Party prompt notice of any such claim and all necessary information and assistance so that the Indemnifying Party, at its option, may defend or settle such claim and the Indemnified Party does not take any adverse position in connection with such claim. In the event that the injury or damage is caused by joint or concurrent negligence of Buyer and Seller, the loss or expense shall be borne by each party in proportion to its degree of negligence. For purposes of Seller's indemnity obligations hereunder, Products shall not be considered third party property and the facility in which a Product or Software is used and/or the Services are performed shall not be considered third party property.

(b) Indemnity by Buyer for Third Party Warranty Claims. If Buyer supplies Products or Services to a third party, uses Products or Services at a facility owned by a third party, and/or transfers Products and/or Software to a third party, Buyer shall indemnify and defend Seller from and against any and all claims by, and liability to, any such third party in excess of the limitations set forth in Sections 10 "Limited Warranty" and 11 "Limitations of Remedy and Liabilities." For purposes of this subsection (b), "Seller" means Seller, its affiliates, suppliers, contractors, licensors and their employees.

13. INTELLECTUAL PROPERTY INDEMNITY:

Seller warrants that, to the best of its knowledge, Products, Services and/or Software furnished hereunder, and any part thereof, (each a "Delivered Item") shall be delivered free of any rightful claim of any third party not affiliated with Buyer for infringement of any U.S. patent, any trademark registered in the U.S. Patent and Trademark Office and/or any copyright registered in the U.S. Copyright Office. Seller will, at its own expense, defend or settle any suits that may be instituted against Buyer for alleged infringement by the Delivered Item of any U.S. patent, any trademark registered in the U.S. Patent and Trademark Office and/or any copyright registered in the U.S. Copyright Office provided that: (a) such alleged infringement consists of the use of the Delivered Item for (i) any of the purposes for which Buyer informed Seller such Delivered Items would be used, or (ii) if Buyer did not so inform Seller, any of the purposes for which Buyer reasonably believed such Delivered Items would be used; (b) Buyer shall have made all payments for such Delivered Items then due hereunder; (c) Buyer shall give Seller immediate notice in writing of any such suit and transmit to Seller immediately upon receipt of all processes and papers served upon Buyer; (d) Buyer does not take any position adverse to Seller in connection with such claim; and (e) Buyer shall permit Seller through Seller's counsel, either in the name of Buyer or in the name of Seller, to defend such suit(s) and give all needed information, assistance and authority to enable Seller to do so.

In case of a final award of damages in any such suit, Seller will pay such award but will not be responsible for any compromise or settlement made without its written consent. In case the Delivered Item itself is in such suit held to infringe any valid patent issued in the United States and/or a trademark and/or copyright registered in the United States, and its use is enjoined, or in the event of a settlement or compromise approved by Seller which shall preclude future use of the Delivered Item, Seller shall, at its own expense and at its sole option, either: (a) procure rights to continue using

such Delivered Item; (b) modify the Delivered Item to render it non-infringing; (c) replace the Delivered Item with a non-infringing Product and/or Software; or (d) refund the purchase price paid by Buyer for the Delivered Item after return of the Delivered Item to Seller (less reasonable depreciation for any period of use). Notwithstanding the foregoing, Seller shall not be held responsible for claims of infringement of any patents covering the use of the Delivered Item in combination with other goods or materials not furnished by Seller.

The foregoing states the entire liability of Seller for intellectual property infringement, and IN NO EVENT SHALL SELLER BE LIABLE FOR CONSEQUENTIAL OR INCIDENTAL DAMAGES ATTRIBUTABLE TO AN INTELLECTUAL PROPERTY INFRINGEMENT. Buyer, at its own expense, shall defend Seller against, and/or settle, (a) any patent, trademark, copyright or other intellectual property infringement claim pertaining to a Delivered Item furnished by Seller to Buyer manufactured in accordance with designs, drawings or other descriptions proposed or furnished by Buyer; and (b) any claim against Seller of contributory infringement resulting from the use or resale by Buyer of a Delivered Item sold hereunder. Buyer shall indemnify Seller for any award against Seller or settlement by Seller regarding any such claims and attorneys' fees and defense costs incurred in defense of such claims.

14. SOFTWARE LICENSE:

(a) License Grant: Seller grants Buyer a nonexclusive, royalty-free, perpetual, limited license to use the Software in the U.S. and solely in conjunction with (a) the operation of the Products purchased and sold under the Contract and/or other product meeting Seller's specifications; and (b) any other purpose agreed upon in a written and signed agreement between Buyer and Seller.

(b) Scope of License: Upon Seller's prior written approval, Buyer may make a reasonable number of copies of Software as necessary for backup, configuration, installation, and restoration of the Products. Also upon Seller's prior written approval, Buyer may authorize a third-party contractor or service provider to exercise these rights on Buyer's behalf and for Buyer's benefit. Buyer may transfer possession of Software and its media to another party only in conjunction with the transfer of the Products on which the Software is loaded and only upon agreement of the other party to the terms and conditions of the Contract. Upon such transfer, Buyer shall destroy all Buyer's copies of Software and related documentation. All licenses and grants pursuant to the Contract shall immediately terminate once Buyer no longer rightfully owns or possesses the Products. No other rights under this license are granted. Upon Seller's request, Buyer shall provide Seller with written notice of any such transfer providing the name, address, and contact information of the subsequent Buyer within 15 days of such transfer.

(c) Use Restrictions: Buyer shall not (a) copy, display, transfer, adapt, modify, or distribute in any form the Software except as set forth in the Contract or in Seller documentation provided by Seller to Buyer with the Software; (b) reverse engineer, disassemble, decompile, or otherwise translate the Software's object code, unless expressly permitted by applicable law without the possibility of contractual waiver; or (c) sublicense or lease the Software or any copy thereof except with the transfer of the Products on which the Software is loaded. Except as provided under the terms of Seller's standard escrow agreement between Seller and Buyer, if applicable, Buyer shall not to make available to any party, without prior written consent from Seller or its authorized agent, source code for the Software. Buyer shall not, directly or indirectly, export or re-export, or knowingly permit the export or re-export of, the Products, or any technical information about the Products, to any country for which the United States Export Administration Act, any regulation thereunder, or any similar United States law or regulation, requires an export license or other United States Government approval, unless Buyer obtains the appropriate export license and obtains written approval from Seller.

(d) Maintenance and Support: Seller may offer to Buyer the option to purchase from Seller annual Software maintenance and support services under the terms and conditions of Seller's then-standard maintenance and support agreement. Buyer may renew this maintenance term at Seller's then-current maintenance rates. In the event Buyer purchases additional Software licenses, maintenance fees for such licenses shall be prorated to be coterminous with Buyer's existing maintenance period. In no event shall Seller be responsible for providing maintenance services for a period during which maintenance coverage is lapsed.

15. SECURITY AGREEMENT AND FINANCING STATEMENTS: As security for payment of the purchase price under the Contract, Buyer hereby irrevocably grants Seller a security interest in the Products purchased by Buyer, together with all accessories, attachments and replacement parts and all substitutions, replacements and proceeds thereof to secure payment of the purchase price and of all monies which may be due under the Contract. Buyer hereby authorizes Seller to file all financing statements, any amendments and continuations thereof, or any other documents necessary or reasonably required, for the perfection and protection of a security interest under applicable law, and to deliver notice to prior holders of security interests, of Seller's security interest in the Products to protect its interest.

16. INSURANCE:

Until payment in full of the purchase price, Buyer shall maintain insurance covering all Products sold by Seller to Buyer in such amounts and against such risks as is customary by companies engaged in the same or similar business and similarly located, and shall, upon Seller's request, furnish evidence of such insurance satisfactory to Seller.

17. DRAWINGS; OTHER DESIGN DATA:

All specifications, drawings, designs, data, information, ideas, methods, product samples, tools, gages, dies, fixtures, patterns and/or inventions made, conceived, developed or acquired by Seller in connection with procuring and/or executing the Contract will vest in and inure to Seller's sole benefit notwithstanding any charges therefor which may have been or may be imposed by Seller on Buyer. Buyer shall not give, loan, exhibit, sell or transfer to any person who is not a Buyer employee and authorized to

Regal Beloit America, Inc.

Terms and Conditions of Sale

receive such information, or to any organization or entity, any drawing, photograph, specification or product sample furnished by Seller or reproduction thereof which may enable such person, organization or entity to furnish similar products or parts therefor.

18. RETURN OF PRODUCTS:

No Product or part shall be returned to Seller without written authorization and shipping instructions first having been obtained from Seller.

19. ASSIGNMENT AND SUBCONTRACTING:

None of Buyer's rights under the Contract shall be assigned by Buyer to any other person, whether by operation of law or otherwise, without Seller's prior written approval. Seller may, without the necessity of obtaining Buyer's prior written consent, assign the Contract or subcontract the production of all or any portion of the Products and/or performance of the Services.

20. CANCELLATION:

No purchase order submitted to Seller may be cancelled by Buyer without the prior written consent of Seller, which consent will at all times be conditioned on Buyer's agreement to pay Seller's cancellation charge. For a finished Product that, in Seller's judgment, is readily resalable to others, the cancellation charge shall be 15% of the invoice price of the Product. For all other cancellations, the cancellation charge shall amount to all cost and expenses incurred by Seller and arising out of or in connection with Buyer's purchase order plus reasonable profit. In no event shall the cancellation charge be less than 10% of the invoice price of the Product or more than the invoice price.

21. HIGH RISK APPLICATION USE DISCLAIMER:

PRODUCTS AND SERVICES SOLD BY SELLER ARE NOT INTENDED FOR USE IN CONNECTION WITH ANY NUCLEAR FACILITY OR ACTIVITY, CRITICAL SAFETY SYSTEM, MEDICAL DEVICE, MILITARY DEVICE, SATELLITE, AVIATION EQUIPMENT, AIR TRAFFIC CONTROL EQUIPMENT, OR OTHER HIGH RISK APPLICATIONS (COLLECTIVELY, "HIGH RISK APPLICATIONS"). SELLER SHALL NOT USE OR PERMIT OTHERS TO USE PRODUCTS OR SERVICES FOR SUCH HIGH RISK APPLICATIONS WITHOUT SELLER'S PRIOR WRITTEN CONSENT. IF SO USED WITHOUT SELLER'S PRIOR WRITTEN CONSENT, SELLER DISCLAIMS ALL LIABILITY FOR ANY DAMAGE,

INJURY OR CONTAMINATION, AND BUYER SHALL INDEMNIFY AND HOLD SELLER, ITS OFFICERS, AGENTS, EMPLOYEES, SUCCESSORS, ASSIGNS AND CUSTOMERS HARMLESS FROM AND AGAINST ANY AND ALL SUCH LIABILITY. SELLER'S CONSENT, IF ANY, WILL BE CONDITIONED UPON ADDITIONAL TERMS AND CONDITIONS ACCEPTABLE TO SELLER.

22. GOVERNING LAW; VENUE:

These Terms and Conditions and the Contract shall be governed by and construed in accordance with the laws of the State of Wisconsin. Seller and Buyer irrevocably submit to the exclusive jurisdiction of the state courts located in Rock County, State of Wisconsin and the federal courts located in the State of Wisconsin, and Seller and Buyer waive any objection to venue or forum non conveniens, for the resolution of any dispute relating to these Terms and Conditions or the Contract. The rights and obligations of Seller and Buyer shall not be governed by the provisions of the United Nations Convention on Contracts for the Internal Sale of Goods.

23. EXPORT/IMPORT: Buyer shall comply, in the receipt and use of the Products and the Software, with all applicable import and export control laws, regulations, orders and requirements of the jurisdictions in which the Seller and Buyer are established or from which Products and Software are provided. Buyer shall not transfer, release, import, or export Products and/or Software in violation of such applicable laws, regulations or other legal requirements. Buyer shall provide a completed end-user certification in a form satisfactory to Seller upon Seller's request.

24. ATTORNEYS' FEES: Buyer agrees to pay all of Seller's costs and expenses of collection and related litigation, including but not limited to attorneys' fees and costs.

25. SALVATORY CLAUSE: The invalidity, in whole or in part, of any of the provisions of these Terms and Conditions, shall not affect the enforceability of any of the other provisions thereof.

26. APPLICABILITY: These Terms and Conditions as stated herein are applicable as of the date of this printing and until such time as changed by Seller.

TERMS & CONDITIONS

TERMS AND CONDITIONS OF SALE SUPPLEMENT B

Limited Warranty -- Exceptions

The following table sets forth substitute language for Section 10(a) (1) "Products" applicable to certain Products of certain business units.

Regal entity and business unit:	If Products are:*	Substitute Section 10(a)(1) with the following:
Regal Beloit America, Inc., Marathon Generators	standby generators	Seller warrants that the Products shall be delivered free from defects in material, workmanship and title and shall conform to Seller's written specification agreed upon by Buyer and Seller in a written and signed agreement, if applicable, for the Products. This warranty shall expire twenty-four (24) months from first use of the Product, thirty (30) months from date of manufacture of the Product, or upon one thousand (1000) hours in use of the Product, whichever occurs first.
Regal Beloit America, Inc., Marathon Motors	Blue Chip® Severe Duty Explosion Proof and EPA compliant motors	Seller warrants that the Products shall be delivered free from defects in material, workmanship and title and shall conform to Seller's written specification agreed upon by Buyer and Seller in a written and signed agreement, if applicable, for the Products. This warranty shall expire twenty-four (24) months from first use of the Product or thirty (30) months from date of manufacture of the Product, whichever occurs first.
Regal Beloit America, Inc., Marathon Motors	Blue Max®, Black Max®, micro-MAX™ Inverter Duty motors and all XRI® motors	Seller warrants that the Products shall be delivered free from defects in material, workmanship and title and shall conform to Seller's written specification agreed upon by Buyer and Seller in a written and signed agreement, if applicable, for the Products. This warranty shall expire thirty-six (36) months from first use of the Product or forty (42) months from date of manufacture of the Product, whichever occurs first.
Regal Beloit America, Inc., Marathon Motors	U-Frame Automotive Duty and IEEE-841 motors	Seller warrants that the Products shall be delivered free from defects in material, workmanship and title and shall conform to Seller's written specification agreed upon by Buyer and Seller in a written and signed agreement, if applicable, for the Products. This warranty shall expire sixty (60) months from first use of the Product or sixty-six (66) months from date of manufacture of the Product, whichever occurs first.

* Certain Products are covered by neither the standard warranty described in subsection 10(a)(1) nor this table. Buyer must consult the applicable current product catalog or internet site or Seller directly to confirm the applicable warranty period.

Revised, May 2014



IMPORTANT INFORMATION

Please Read Carefully



This catalog is not intended to provide operational instructions. Appropriate Marathon Motors instructions provided with the motor and precautions attached to the motor should be read carefully prior to installation, operation and/or maintenance of the equipment. Injury to personnel or motor failure may be caused by improper installation, maintenance or operation.

The following and information is supplied to you for your protection and to provide you with many years of trouble free and safe operation of your Marathon Motors product:



- Disconnect power and lock out driven equipment before working on a motor.
- Always keep hands and clothing away from moving parts.
- The lifting support on the motor is not to be used to lift the entire machine. Only the motor attached directly to the support may be safely lifted by the support.
- Install and ground per local and national codes.
- Discharge all capacitors before servicing a single phase motor.
- Misapplication of a motor in a hazardous environment can cause fire or an explosion and result in serious injury. Only the end user, local authority having jurisdiction, and/or insurance underwriter are qualified to identify the appropriate class(es), group(s), division and temperature code. Marathon Motors personnel can not evaluate or recommend what motors may be suitable for use in hazardous environments. If a motor is nameplated for hazardous locations, do not operate the motor without all of the grease and drain plugs installed.
- Never attempt to measure the temperature rise of a motor by touch. Temperature rise must be measured by thermometer, resistance, imbedded detector or thermocouple.
- Motors with automatic reset thermal protectors will automatically restart when the protector temperature drops sufficiently. Do not use motors with automatic reset thermal protectors in applications where automatic restart will be hazardous to personnel or equipment.
- Motors with manual reset thermal protectors may start unexpectedly after the protector trips when the surrounding air is at +20°Fahrenheit or lower. If the manual reset protector trips, disconnect motor from its power supply. After the protector cools (five minutes or more), it can be reset and power may be applied to the motor.
- Connect all protective device leads, marked P1, P2, etc., per instructions supplied with the motor.
- Operation of a motor at other than its nameplate rating may result in fire, damage to equipment or serious injury to personnel.
- For safety, Buyer or User should provide protective guards over all shaft extensions and any moving apparatus mounted thereon. The User is responsible for checking all applicable safety codes in his area and providing suitable guards. Failure to do so may result in bodily injury and/or damage to equipment.



- Consult qualified personnel with questions and all electrical repairs must be performed by trained and qualified personnel only.
- For motors nameplated as "belted duty only", do not operate the motor without belts properly installed.
- Motors and/or driven equipment should not be operated faster than their rated speed.
- For inverter applications, follow the inverter manufacturer's installation guidelines.
- Make sure the motor is properly secured and aligned before operation.

Resale of Goods

In the event of the resale of any of the goods, in whatever form, Resellers/Buyers will include the following language in a conspicuous place and in a conspicuous manner in a written agreement covering such sale:

The manufacturer makes no warranty or representations, express or implied, by operation of law or otherwise, as to the merchantability or fitness for a particular purpose of the goods sold hereunder. Buyer acknowledges that it alone has determined that the goods purchased hereunder will suitably meet the requirements of their intended use. In no event will the manufacturer be liable for consequential, incidental or other damages. Even if the repair or replacement remedy shall be deemed to have failed of its essential purpose under Section 2-719 of the Uniform Commercial Code, the manufacturer shall have no liability to Buyer for consequential damages.

Resellers/Buyers agree to also include this entire document including the warnings and cautions above in a conspicuous place and in a conspicuous manner in writing to instruct users on the safe usage of the product.

This information should be read together with all other printed information supplied by Marathon Motors.

For more information contact: **Regal Beloit America, Inc.**, 100 E. Randolph St., Wausau, WI 54401 Phone: 715-675-3311 or Fax: 715-675-8030.

FREQUENTLY ASKED QUESTIONS

ENERGY INDEPENDENCE AND SECURITY ACT OF 2007 (“EISA”)

These materials are intended to provide general information (not legal or other advice) about important new legislation or developments. These materials are not intended to substitute for a thorough analysis of the subject covered or any subsequent developments relating to that subject.

Q. Are medium voltage motors covered by EISA?

A. No. EISA only covers motors that are operational at 60 Hz with voltages through 600 V.

Q. Must 60/50 Hz rated motors meet EISA efficiencies?

A. Yes, 60/50 Hz motors must comply with the applicable efficiency requirement at the 60 Hz rating. 50 Hz only motors are exempt.

Q. What efficiencies are documented in NEMA tables 12-11, 12-12, 12-13 and 12-14?

A. NEMA table 12-11 defines efficiencies associated with EAct. 12-12 contains efficiencies associated with NEMA Premium (former CEE efficiencies). 12-13 defines medium voltage (>600V). 12-14 defines NEMA Premium levels @ 50 Hz.

Q. Must spread voltage (eg. 200-230/460V) or tri-voltage (eg. 230/460/796) rated motors meet EISA efficiencies at all rated voltages?

A. Yes. The motor must meet the required efficiency at each rated voltage on the nameplate. Note that since the efficiency requirements of the stated voltages may vary (200V must meet “EAct”/Table 12-11, whereas 230 & 460 must meet “NEMA Premium”/Table 12-12), varying efficiency claims must be made on the same nameplate.

Q. What about 208 volt?

A. Our view on 208 volt, is that it must meet EAct efficiencies.

Q. Are single phase motors covered by EISA?

A. No, regardless of motor frame size or HP rating.

Q. Are 48 and 56 frame motors covered by EISA?

A. No. However there are discussions about the possible establishment of efficiency standards for fractional HP motors.

Q. Are “inverter duty” motors covered by EISA?

A. Yes, if the motor is operational at 60 Hz. If the motor can be used as a “general purpose” motor, it must meet EISA-mandated efficiency. Special V/Hz motors (eg. 45Hz/230V) are not covered, nor are special ventilation schemes such as blower cooled or TENV.

Q. Are motors that are intermittent duty or 60 minute duty covered?

A. Motors that are truly intermittent duty or time limited and will fail if operated continuously are not covered. Motors that are labeled for less than continuous duty but are capable of operating continuously are covered.

Q. Are motors with brakes covered? What about gearmotors?

A. Motors that have brakes installed on the motor are not covered. Motors that are purchased with a shaft extension or “brake provisions” are covered. Motors that are part of the gear assembly and share bearings or other components such that they cannot operate without the gear assembly are not covered. Motors that can be operated separately but are used with a gearbox are covered.

Q. Are motors with encoders or encoder provisions covered?

A. Yes, both motor with encoders and motors with encoder provisions are covered based upon their other features such as enclosure, voltage and frequency. The inclusion of an encoder or other accessories is not required for the motor to operate so they are not considered reasons for exemption.

Q. Are multi-speed motors covered?

A. No, multi-speed motors (ex: 25/12.5hp 1800/900rpm) are not covered. There are no efficiency levels established for multi-speed motors so they cannot be labeled as EAct or NEMA Premium regardless of the efficiency value.

Q. Are eight (8) pole motors covered?

A. Yes, eight-pole motors operating on 60Hz power supplies are covered. There are no NEMA Premium efficiency levels defined for eight-pole motors so they cannot be labeled as NEMA Premium even if the efficiency exceeds EAct (Table 12-11) levels.

NEMA MG-1 Table 12-11 Full Load Efficiencies of EAct Efficient Electric Motors

HP	NOMINAL FULL LOAD EFFICIENCY							
	OPEN FRAME				ENCLOSED FRAME			
	2 POLE	4 POLE	6 POLE	8 POLE	2 POLE	4 POLE	6 POLE	8 POLE
1	N/A	82.5	80.0	74.0	75.5	82.5	80.0	74.0
1 1/2	82.5	84.0	84.0	75.5	82.5	84.0	85.5	77.0
2	84.0	84.0	85.5	85.5	84.0	84.0	86.5	82.5
3	84.0	86.5	86.5	86.5	85.5	87.5	87.5	84.0
5	85.5	87.5	87.5	87.5	87.5	87.5	87.5	85.5
7 1/2	87.5	88.5	88.5	88.5	88.5	89.5	89.5	85.5
10	88.5	89.5	90.2	89.5	89.5	89.5	89.5	88.5
15	89.5	91.0	90.2	89.5	90.2	91.0	90.2	88.5
20	90.2	91.0	91.0	90.2	90.2	91.0	90.2	89.5
25	91.0	91.7	91.7	90.2	91.0	92.4	91.7	89.5
30	91.0	92.4	92.4	91.0	91.0	92.4	91.7	91.0
40	91.7	93.0	93.0	91.0	91.7	93.0	93.0	91.0
50	92.4	93.0	93.0	91.7	92.4	93.0	93.0	91.7
60	93.0	93.6	93.6	92.4	93.0	93.6	93.6	91.7
75	93.0	94.1	93.6	93.6	93.0	94.1	93.6	93.0
100	93.0	94.1	94.1	93.6	93.6	94.5	94.1	93.0
125	93.6	94.5	94.1	93.6	94.5	94.5	94.1	93.6
150	93.6	95.0	94.5	93.6	94.5	95.0	95.0	93.6
200	94.5	95.0	94.5	93.6	95.0	95.0	95.0	94.1
250	94.5	95.4	95.4	94.5	95.4	95.0	95.0	94.5
300	95.0	95.4	95.4	N/A	95.4	95.4	95.0	N/A
350	95.0	95.4	95.4	N/A	95.4	95.4	95.0	N/A
400	95.4	95.4	N/A	N/A	95.4	95.4	N/A	N/A
450	95.8	95.8	N/A	N/A	95.4	95.4	N/A	N/A
500	95.8	95.8	N/A	N/A	95.4	95.8	N/A	N/A

NEMA TABLE 12-11

NEMA MG-1 Table 12-12 Full Load Efficiencies for 60 Hz NEMA Premium® (CEE) Efficient Electric Motors Rated 600 Volts or less (Random Wound)

HP	NOMINAL FULL LOAD EFFICIENCY							
	OPEN FRAME				ENCLOSED FRAME			
	2 POLE	4 POLE	6 POLE	8 POLE	2 POLE	4 POLE	6 POLE	8 POLE
1	77.0	85.5	82.5	N/A	77.0	85.5	82.5	N/A
1 1/2	84.0	86.5	86.5	N/A	84.0	86.5	87.5	N/A
2	85.5	86.5	87.5	N/A	85.5	86.5	88.5	N/A
3	85.5	89.5	88.5	N/A	86.5	89.5	89.5	N/A
5	86.5	89.5	89.5	N/A	88.5	89.5	89.5	N/A
7 1/2	88.5	91.0	90.2	N/A	89.5	91.7	91.0	N/A
10	89.5	91.7	91.7	N/A	90.2	91.7	91.0	N/A
15	90.2	93.0	91.7	N/A	91.0	92.4	91.7	N/A
20	91.0	93.0	92.4	N/A	91.0	93.0	91.7	N/A
25	91.7	93.6	93.0	N/A	91.7	93.6	93.0	N/A
30	91.7	94.1	93.6	N/A	91.7	93.6	93.0	N/A
40	92.4	94.1	94.1	N/A	92.4	94.1	94.1	N/A
50	93.0	94.5	94.1	N/A	93.0	94.5	94.1	N/A
60	93.6	95.0	94.5	N/A	93.6	95.0	94.5	N/A
75	93.6	95.0	94.5	N/A	93.6	95.4	94.5	N/A
100	93.6	95.4	95.0	N/A	94.1	95.4	95.0	N/A
125	94.1	95.4	95.0	N/A	95.0	95.4	95.0	N/A
150	94.1	95.8	95.4	N/A	95.0	95.8	95.8	N/A
200	95.0	95.8	95.4	N/A	95.4	96.2	95.8	N/A
250	95.0	95.8	95.4	N/A	95.8	96.2	95.8	N/A
300	95.4	95.8	95.4	N/A	95.8	96.2	95.8	N/A
350	95.4	95.8	95.4	N/A	95.8	96.2	95.8	N/A
400	95.8	95.8	95.8	N/A	95.8	96.2	95.8	N/A
450	95.8	96.2	96.2	N/A	95.8	96.2	95.8	N/A
500	95.8	96.2	96.2	N/A	95.8	96.2	95.8	N/A

NEMA TABLE 12-12

Our New Corporate Identity is Simply "Regal"



SIMPLE.

Regal-Beloit Corporation, the parent of Marathon Motors, is in the midst of simplification. We are streamlining our business processes, standardizing our computer systems, and improving our communications – all with the idea of making it easier for customers to do business with us.

DYNAMIC.

As a corporation, we are becoming a more dynamic enterprise—continuously innovating and growing to reach more customers in more markets. And we are doing so with the confidence that comes with our years of industry experience.



BOLD.

As we bring life to the new Regal identity, our brand boldly reflects our corporate objective to become a more focused, integrated and customer centric company.



As a premier Regal brand, Marathon Motors will continue as a dynamic and customer focused brand serving partners around the world. The Marathon Motors brand promise remains providing customers with a vast array of efficient solutions for commercial and industrial applications performing every day for the long run.

REGAL

Footnotes

1	Capacitor Start/Capacitor Run design for reduced amperage	77	Frame size is drilled with three sets of footholes, 5010, 5011, and 5012 as standard. Foothole drilling for 5009 available upon request, as a build-up
2	Capacitor Start Induction Run design	78	Frame size is drilled with two sets of footholes, 5012 and 5013 standard
3	Split Phase design	79	Ball brgs on both ends suitable for direct connection. For belted applications, refer to Customer Service
4	Sleeve bearing	80	Rolled steel fan guard on 143T-145T
5	56H, 143T, and 145T Combination Base with 12 mounting holes	81	24" long #18 SO 2-conductor cord out shell at 11 o'clock position
6	Bolt-on removable base for footless mounting option	82	Welded Rigid Base
7	Shaft extension 1-1/2" long by 1/2" diameter	83	Shaft extension 1-7/8" long by 5/8" diameter with 6-3/8" mounting flange
8	Shaft extension 1-7/8" long by 1/2" diameter	84	NEMA 145T C-Face mounting with removable 182T rigid base
9	Shaft extension 2-1/4" long by 1/2" diameter	85	Not tach adaptable
10	Shaft extension 2-1/4" long by 5/8" diameter	86	2:1 constant torque speed range; RTM for greater torque capability
11	Shaft extension 2-1/4" long by 7/8" diameter	87	10:1 Constant Torque available as build-up, RTM for price and availability
12	With rigid base	88	182T base and shaft height, 145TC mounting face and shaft dimensions
13	F1 Mounting only, cannot reassemble to F2	89	Threaded NPT opening in conduit box
14	Will accept C-Face kit, see Accessory Section	90	Not UL Recognized
15	Fixed CW Rotation, viewing opposite shaft (or lead end) of motor	91	Suitable for use on VFD at 208 volt
16	Fixed CCW Rotation, viewing opposite shaft (or lead end) of motor	92	7/8" Thru-bolts, shaft end
17	1.0 Service Factor	93	Permanent split capacitor-switchless
18	1.15 Service Factor	94	1/2" Thru-bolts, shaft end
19	1.25 Service Factor	95	Will not accept drip cover kit
20	1.35 Service Factor	96	3 lead reversible design works with single pole, double throw reversing switch
21	Double shaft extension 1-1/2" long by 1/2" diameter with flat each end	97	Addition of D-Flange kit will result in non-NEMA "BA" dimension (1/2" longer than NEMA) and non-NEMA shaft extension (1/2" shorter than NEMA).
22	Double shaft extension 1-7/8" long by 5/8" diameter each end	98	Not UL Listed for Fire Pump applications
23	Shaft extension 3/8" diameter	99	Suitable for 2:1 CT operation
24	Motor will NOT accept a Brake kit	100	6" shaft extension with 2 flats 90° apart
25	Motor will NOT accept C-Face Kits	110	1.20 Service Factor
26	5/8" shaft adapter included	111	1.30 Service Factor
27	Drip Cover included	112	1.40 Service Factor
28	Steel Endshields	113	1.50 Service Factor
29	Weep holes with removable plugs on end brackets. Remove bottom plug after installation	114	1.60 Service Factor
30	Resilient ring mount, base not included	115	1.75 Service Factor
31	5/8" Thru-bolts, shaft end	116	1-3/4" thru-bolt extension on shaft-end
32	3/4" Thru bolts, shaft end	2:1	Suitable for 2:1 CT operation; consult "R164 Rework" table for fan change pricing to upgrade to 10:1 CT
33	Shaft extension 6" long by 5/8" diameter with full flat and key 90° apart	A	NEMA Design A
34	1" Thru-bolts, shaft end	B	NEMA Design B
35	1-1/8" Thru-bolts, shaft end	C	NEMA Design C
36	1-1/4" Thru-bolts, shaft end	D	Will become build-up item when current stock is gone
37	1-1/2" Thru-bolts, shaft end	E	Design incorporates electronic switch
38	2" Thru-bolts, shaft end	F	Class F Insulation
39	No Thru-bolts, shaft end	H	Class H Insulation
40	Space heaters and 100 ohm platinum stator RTDs included	I	Reduced HP @ 120 HZ
41	1/2" Thru-bolts, opposite shaft end	N	Totally Enclosed, Non-Ventilated
42	3/4" Thru-bolts, opposite shaft end	P	BCP (Bearing Current Protection)
43	2-1/2" Resilient Rings included	Q	Quick Connect" terminal board
44	1" Thru-bolts, opposite shaft end	S	Steel Frame Construction
45	60° C ambient	V	Suitable for 10:1 CT 60 minute duty, otherwise 2:1 CT
46	65° C ambient	X	XRI, Ultra High Efficiency Design
47	Connected for CCW rotation (U.S. standard) facing opposite shaft end. Reversible by reconnection of leads	Z	56HZ with 7/8" shaft dia., 3-1/2" shaft height, and slotted 56 frame base
48	Connected for CW rotation (Canadian standard) facing opposite shaft end. Reversible by reconnection of leads	AH	Conforms to GM 7EH and satisfies Ford EM-1 and GM 7EQ
49	Shaft extension 1-13/16" long by 1/2" diameter with 6-3/8" mounting flange	AL	Aluminum Frame Construction
50	Designed for 50 Hz operation	AQ	Conforms to GM 7EQ and satisfies Daimler Chrysler NPEM-100, and Ford EM-1
51	Does not include resilient rings, see Accessory Section	BI	Class B Insulation
52	1/2" x 1-7/8" Shaft with 1-5/8" Flat	BP	Separate power supply required for blower motor
53	1/2" Shaft with 5/8" adapter and Key	CD	Suitable for Group C
54	30 minute duty cycle, not rated for continuous duty	CF	Consult Factory for Accessory Kit and/or Modification Selection
55	Shaft extension 3-13/16" long by 5/8" diameter with 3.5" keyway	CT	Suitable for 20:1 CT on Vector Drive, continuous duty or 2000:1
56	1-5/8" Thru-bolts, shaft end	ES	Energy Saver Design
57	Open construction	FN	Drive has cooling fan
58	Capacitor supplied with motor	NE	Exempt from NEMA Premium efficiency requirement
59	TEAO construction	NP	Does not meet NEMA PremiumR efficiency
60	Foot locating Set Screws on frame, 90 apart	NS	Single Shielded Ball Bearings
61	10" Leads	PW	Part Winding Start Capability
62	43" Leads	RB	Roller Bearing on shaft end for belted load only
63	1-1/2" Thru-bolts, opposite shaft end	SH	Space heaters
65	Mounting accessories and resilient ring for pulley end are not included. Use accessory kit 161L131AB1 for resilient ring mounting	SL	Sound level exceeds standard
67	Capacitor not included, see Accessory Section	TS	Normally Closed Thermostats installed
68	Rated 60/50 hertz, 190/380 or 380 volt at next lower horsepower	VB	Vibration not met
69	50° C Ambient	VC	Voltage Change Device feature for quick voltage changes
70	Not Nameplated 50 hz	YD	12 Leads for WYE-DELTA, Part Winding on low voltage, or across-the-line starting
71	Includes length adapter bracket		
72	Usable on 200 Volts at 1.0 service factor		
73	No hubs		
74	Split phase/capacitor run electrical design		
75	Addition of C-Face Kits may result in non-NEMA "BA", dimension. For the resulting "BA" dimension consult chart found in modification section		
76	Addition of C-Face Kits in non-NEMA "AH" dimension. "AH" is 2.12, Rework "AH" is 2.38		

IEC Quick Reference Dimensional Chart

B3 Foot-Mounted (Ridge Base)

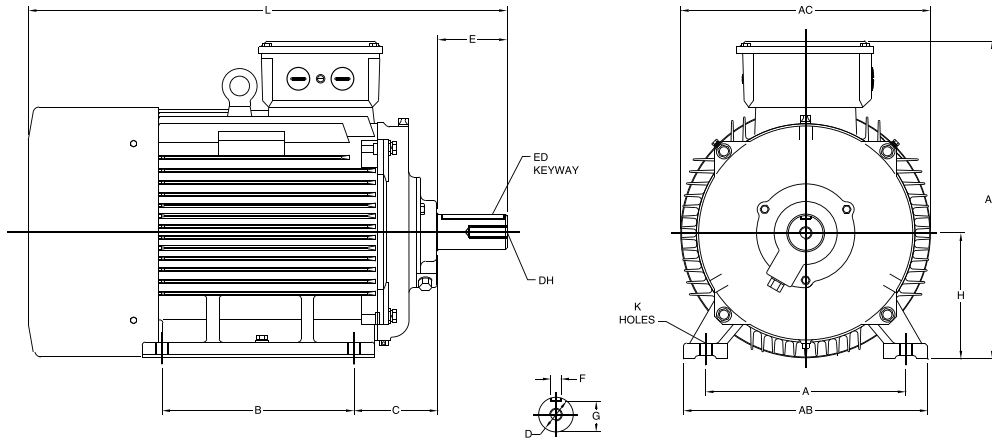

IEC Frame Dimensions (Millimeters)

FRAME	MOUNTING						SHAFT					GENERAL			B5 (FF) FLANGE						B14 (FT) FACE						
	A	B	C	H	AB	K	D	E	F	G	ED	DH	AC	AD	HD	M	N	P	S	T	LA	M	N	P	S	T	LA
63	100	80	40	63	119	7	11	23	4	8.5	10	M4 x 10	126	-	169	115	95	140	10	3.0	7	75	60	90	M5	2.5	7
71	112	90	45	71	131	7	14	30	5	11.0	20	M5 x 12.5	140	-	186	130	110	160	10	3.5	7	85	70	105	M6	2.5	9
80	125	100	50	80	157	10	19	40	6	15.5	25	M6 x 16	158	132	212	165	130	200	12	3.5	12	100	80	120	M6	3.0	9
90S	140	100	56	90	174	10	24	50	8	20.0	32	M8 x 19	178	140	230	165	130	200	12	3.5	12	115	95	140	M8	3.0	9
90L	140	125	56	90	174	10	24	50	8	20.0	32	M8 x 19	178	140	230	165	130	200	12	3.5	12	115	95	140	M8	3.0	9
100L	160	140	63	100	205	12	28	60	8	24.0	40	M10 x 22	215	178	278	215	180	250	15	4.0	11	130	110	160	M8	3.5	14
112M	190	140	70	112	245	12	28	60	8	24.0	40	M10 x 22	220	190	302	215	180	250	15	4.0	12	130	110	160	M8	3.5	11
132S	216	140	89	132	280	12	38	80	10	33.0	56	M12 x 28	275	210	342	265	230	300	15	4.0	12	165	130	200	M10	3.5	14
132M	216	178	89	132	280	12	38	80	10	33.0	56	M12 x 28	275	210	342	265	230	300	15	4.0	12	165	130	200	M10	3.5	14
160M	254	210	108	160	325	15	42	110	12	37.0	80	M16 x 36	325	254	414	300	250	350	19	5.0	13	215	180	250	M12	4.0	13
160L	254	254	108	160	325	15	42	110	12	37.0	80	M16 x 36	325	254	414	300	250	350	19	5.0	13	215	180	250	M12	4.0	13
180M	279	241	121	180	335	15	48	110	14	42.5	80	M16 x 36	360	310	490	300	250	350	19	5.0	15	NOT DEFINED BY IEC 72					
180L	279	279	121	180	335	15	48	110	14	42.5	80	M16 x 36	360	310	490	300	250	350	19	5.0	15						
200L	318	305	133	200	395	19	55	110	16	49.0	100	M20 x 42	400	340	540	350	300	400	19	5.0	19.5						
225S	356	286	149	225	435	19	55*/ 60	110*/ 140	16*/ 18	49*/ 53	100*/ 125	M20 x 42	445	414	639	400	350	450	19	5.0	21.0						
225M	356	311	149	225	435	19	55*/ 60	110*/ 140	16*/ 18	49*/ 53	100*/ 125	M20 x 42	445	414	639	400	350	450	19	5.0	21.0						
250M	406	349	168	250	490	24	60*/ 65	140	18	53*/ 58	125	M20 x 42	500	440	690	400	350	450	19	5.0	21.0						

*2 Pole Dimensions

1mm = .03937", 1" = 25.4mm

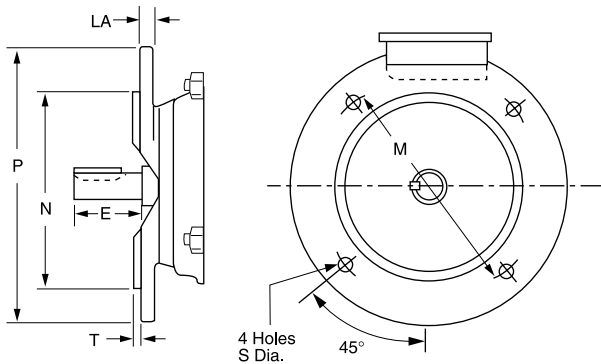

FF Flange B5 Mount

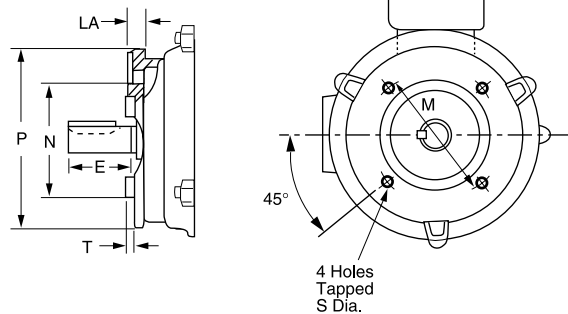

FT Face B14 Mount

NEMA Quick Reference Dimensional Chart

Typical C-Face Motor

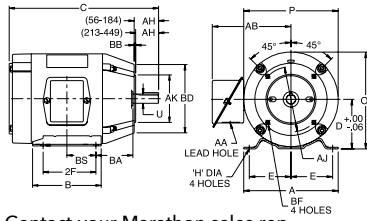

Typical Rigid Base Motor

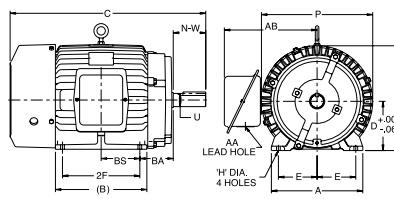

NEMA C-Face	BA Dim.
143-5TC	2-3/4
182-4TC	3-1/2
213-5TC	4-1/4
254-6TC	4-3/4

Contact your Marathon sales rep. for "AB", "O", & "P" Dim.

Refer to your Marathon catalog for "C" Dim.

FRAME	D	E	2F	H	U	N-W	AA	AH	AJ	AK	BA	BB (MIN)	BD (MAX)	BF
48	3.00	2.12	2.75	.34 SLOT	.5000	1.50	1/2	1.69	3.750	3.000	2.50	.13	5.62	1/4-20
56	3.50	2.44	3.00	.34 SLOT	.6250	1.88	1/2	2.06	5.875	4.500	2.75	.13	6.50	3/8-16
56H	3.50	2.44	5.00	.34 SLOT	.6250	1.88	1/2	2.06	5.875	4.500	2.75	.13	6.50	3/8-16
143T	3.50	2.75	4.00	.34	.8750	2.25	3/4	2.12	5.875	4.500	2.25	.13	6.50	3/8-16
145T	3.50	2.75	5.00	.34	.8750	2.25	3/4	2.12	5.875	4.500	2.25	.13	6.50	3/8-16
182	4.50	3.75	4.50	.41	.8750	2.25	3/4	2.12	5.875	4.500	2.75	.13	6.50	3/8-16
184	4.50	3.75	5.50	.41	.8750	2.25	3/4	2.12	5.875	4.500	2.75	.13	6.50	3/8-16
182T	4.50	3.75	4.50	.41	1.125	2.75	3/4	2.62	7.250	8.500	2.75	.25	9.00	1/2-13
184T	4.50	3.75	5.50	.41	1.125	2.75	3/4	2.62	7.250	8.500	2.75	.25	9.00	1/2-13
213	5.25	4.25	5.50	.41	1.125	3.00	1	2.75	7.250	8.500	3.50	.25	9.00	1/2-13
215	5.25	4.25	7.00	.41	1.125	3.00	1	2.75	7.250	8.500	3.50	.25	9.00	1/2-13
213T	5.25	4.25	5.50	.41	1.375	3.38	1	3.12	7.250	8.500	3.50	.25	9.00	1/2-13
215T	5.25	4.25	7.00	.41	1.375	3.38	1	3.12	7.250	8.500	3.50	.25	9.00	1/2-13
254U	6.25	5.00	8.25	.53	1.375	3.75	1-1/4	3.50	7.250	8.500	4.25	.25	10.00	1/2-13
256U	6.25	5.00	10.00	.53	1.375	3.75	1-1/4	3.50	7.250	8.500	4.25	.25	10.00	1/2-13
254T	6.25	5.00	8.25	.53	1.625	4.00	1-1/4	3.75	7.250	8.500	4.25	.25	10.00	1/2-13
256T	6.25	5.00	10.00	.53	1.625	4.00	1-1/4	3.75	7.250	8.500	4.25	.25	10.00	1/2-13
284U	7.00	5.50	9.50	.53	1.625	4.88	1-1/2	4.62	9.000	10.500	4.75	.25	11.25	1/2-13
286U	7.00	5.50	11.00	.53	1.625	4.88	1-1/2	4.62	9.000	10.500	4.75	.25	11.25	1/2-13
284T	7.00	5.50	9.50	.53	1.875	4.62	1-1/2	4.38	9.000	10.500	4.75	.25	11.25	1/2-13
286T	7.00	5.50	11.00	.53	1.875	4.62	1-1/2	4.38	9.000	10.500	4.75	.25	11.25	1/2-13
284TS	7.00	5.50	9.50	.53	1.625	3.25	1-1/2	3.00	9.000	10.500	4.75	.25	11.25	1/2-13
286TS	7.00	5.50	11.00	.53	1.625	3.25	1-1/2	3.00	9.000	10.500	4.75	.25	11.25	1/2-13
324U	8.00	6.25	10.50	.66	1.875	5.62	2	5.38	11.000	12.500	5.25	.25	14.00	5/8-11
326U	8.00	6.25	12.00	.66	1.875	5.62	2	5.38	11.000	12.500	5.25	.25	14.00	5/8-11
324T	8.00	6.25	10.50	.66	2.125	5.25	2	5.00	11.000	12.500	5.25	.25	14.00	5/8-11
326T	8.00	6.25	12.00	.66	2.125	5.25	2	5.00	11.000	12.500	5.25	.25	14.00	5/8-11
324TS	8.00	6.25	10.50	.66	1.875	3.75	2	3.50	11.000	12.500	5.25	.25	14.00	5/8-11
326TS	8.00	6.25	12.00	.66	1.875	3.75	2	3.50	11.000	12.500	5.25	.25	14.00	5/8-11
364U	9.00	7.00	11.25	.66	2.125	6.38	2-1/2	6.12	11.000	12.500	5.88	.25	14.00	5/8-11
365U	9.00	7.00	12.25	.66	2.125	6.38	2-1/2	6.12	11.000	12.500	5.88	.25	14.00	5/8-11
364T	9.00	7.00	11.25	.66	2.375	5.88	2-1/2	5.62	11.000	12.500	5.88	.25	14.00	5/8-11
365T	9.00	7.00	12.25	.66	2.375	5.88	2-1/2	5.62	11.000	12.500	5.88	.25	14.00	5/8-11
364TS	9.00	7.00	11.25	.66	1.875	3.75	2-1/2	3.50	11.000	12.500	5.88	.25	14.00	5/8-11
365TS	9.00	7.00	12.25	.66	1.875	3.75	2-1/2	3.50	11.000	12.500	5.88	.25	14.00	5/8-11
404U	10.00	8.00	12.25	.81	2.375	7.12	3	6.88	11.000	12.500	6.62	.25	15.50	5/8-11
405U	10.00	8.00	13.75	.81	2.375	7.12	3	6.88	11.000	12.500	6.62	.25	15.50	5/8-11
404T	10.00	8.00	12.25	.81	2.875	7.25	3	7.00	11.000	12.500	6.62	.25	15.50	5/8-11
405T	10.00	8.00	13.75	.81	2.875	7.25	3	7.00	11.000	12.500	6.62	.25	15.50	5/8-11
404TS	10.00	8.00	12.25	.81	2.125	4.25	3	4.00	11.000	12.500	6.62	.25	15.50	5/8-11
405TS	10.00	8.00	13.75	.81	2.125	4.25	3	4.00	11.000	12.500	6.62	.25	15.50	5/8-11
444U	11.00	9.00	14.50	.81	2.875	8.62	3	8.38	14.000	16.000	7.50	.25	18.00	5/8-11
445U	11.00	9.00	16.50	.81	2.875	8.62	3	8.38	14.000	16.000	7.50	.25	18.00	5/8-11
444T	11.00	9.00	14.50	.81	3.375	8.50	3	8.25	14.000	16.000	7.50	.25	18.00	5/8-11
445T	11.00	9.00	16.50	.81	3.375	8.50	3	8.25	14.000	16.000	7.50	.25	18.00	5/8-11
444TS	11.00	9.00	14.50	.81	2.375	4.75	3	4.50	14.000	16.000	7.50	.25	18.00	5/8-11
445TS	11.00	9.00	16.50	.81	2.375	4.75	3	4.50	14.000	16.000	7.50	.25	18.00	5/8-11
447T	11.00	9.00	20.00	.81	3.375	8.50	3	8.25	14.000	16.000	7.50	.25	18.00	5/8-11
449T	11.00	9.00	25.00	.81	3.375	8.50	3	8.25	14.000	16.000	7.50	.25	18.00	5/8-11
447TS	11.00	9.00	20.00	.81	2.375	4.75	4 NPT	4.50	14.000	16.000	7.50	.25	18.00	5/8-11
449TS	11.00	9.00	25.00	.81	2.375	4.75	4 NPT	4.50	14.000	16.000	7.50	.25	18.00	5/8-11

marathonTM
Motors



100 East Randolph St., P.O. Box 8003
Wausau, WI 54402-8003
PH: 715-675-3311

www.marathonelectric.com

A Regal Brand



www.regalbeloit.com